

# General Specifications

## Electrical Capacity (Resistive Load)

**Power Level (silver):** 0.1A maximum @ 30V AC/DC

## Other Ratings

**Contact Resistance:** 50 milliohms maximum  
**Insulation Resistance:** 100 megohms minimum @ 500V DC  
**Dielectric Strength:** 500V AC minimum for 1 minute minimum  
**Mechanical Life:** 100,000 operations minimum  
**Electrical Life:** 50,000 operations minimum  
**Nominal Operating Force:** 3.43N  
**Contact Timing:** Nonshorting (break before make)  
**Travel:** Pretravel .087" (2.2mm); Overtravel .031" (0.8mm); Total Travel .118" (3.0mm)

## Materials & Finishes

**Housing:** Glass fiber reinforced polyamide  
**Base:** Glass fiber reinforced polyamide  
**Movable Contact:** Phosphor bronze with silver plating  
**Stationary Contacts:** Phosphor bronze with silver plating  
**Common Terminal:** Phosphor bronze with silver plating  
**End Terminals:** Phosphor bronze with silver plating  
**Lamp Terminals:** Phosphor bronze with silver plating

## Environmental Data

**Operating Temperature Range:** -25°C through +50°C (-13°F through +122°F) for Illuminated  
 -25°C through +70°C (-13°F through +158°F) for Nonilluminated  
**Humidity:** 90 ~ 95% humidity for 96 hours @ 40°C (104°F)  
**Vibration:** 10 ~ 55Hz with peak-to-peak amplitude of 1.5mm traversing the frequency range & returning in 1 minute; 3 right angled directions for 2 hours  
**Shock:** 50G (490m/s<sup>2</sup>) acceleration (tested in 6 right angled directions, with 5 shocks in each direction)

## Installation

**Mounting Torque:** 0.49Nm (4.34 lb•in) maximum for round mounting nut  
**Cap Installation Force:** 9.8N (2.2 lbf) maximum downward force on cap  
**Soldering Time & Temperature:** Manual Soldering: See Profile A in Supplement section.

## Standards & Certifications

**UL:** **File No. E44145 - Recognized only when ordered with marking on switch.**  
 Add "/U" or "/CUL" before first dash in part number to order UL recognized switch.  
 All models recognized at 0.1A @ 30V AC/DC.

# Distinctive Characteristics

Full face and spot illumination available. Front panel relamping.

Choice of super bright LEDs in white, green, and blue in addition to bright red, amber, and green LEDs.

Compact front panel design with 9mm square or round bezel options.

Rear panel threaded mounting. Behind panel depth of less than one inch. 8mm body diameter fits common size panel cutout.

Latchdown feature gives indication of circuit status. Audible and tactile feedback with smooth and responsive operation.

Dual, sliding contacts with self-cleaning action provide contact stability, high reliability, and increased operating life.

Solder lug terminals have spacing of .100" (2.54mm) for choice of mounting.

Longer normally closed terminal facilitates wiring and soldering.

Molded-in terminals lock out flux, dust, and other contaminants.

Matching indicators available.

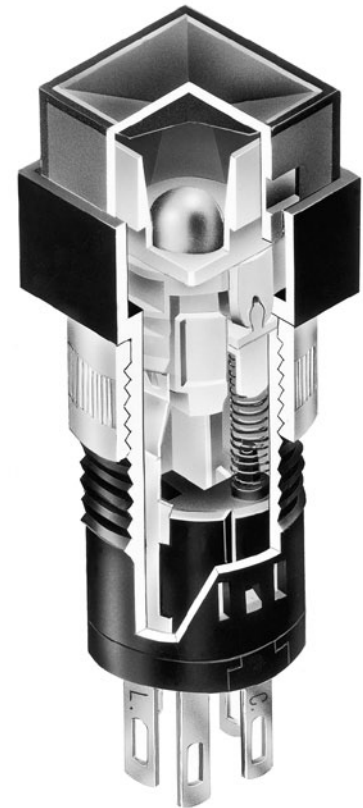

Actual Size

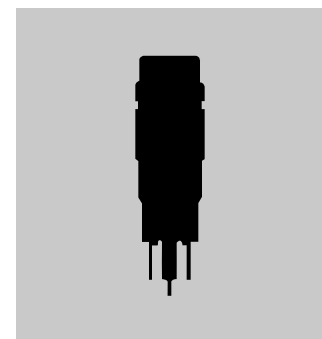

### TYPICAL SWITCH ORDERING EXAMPLE

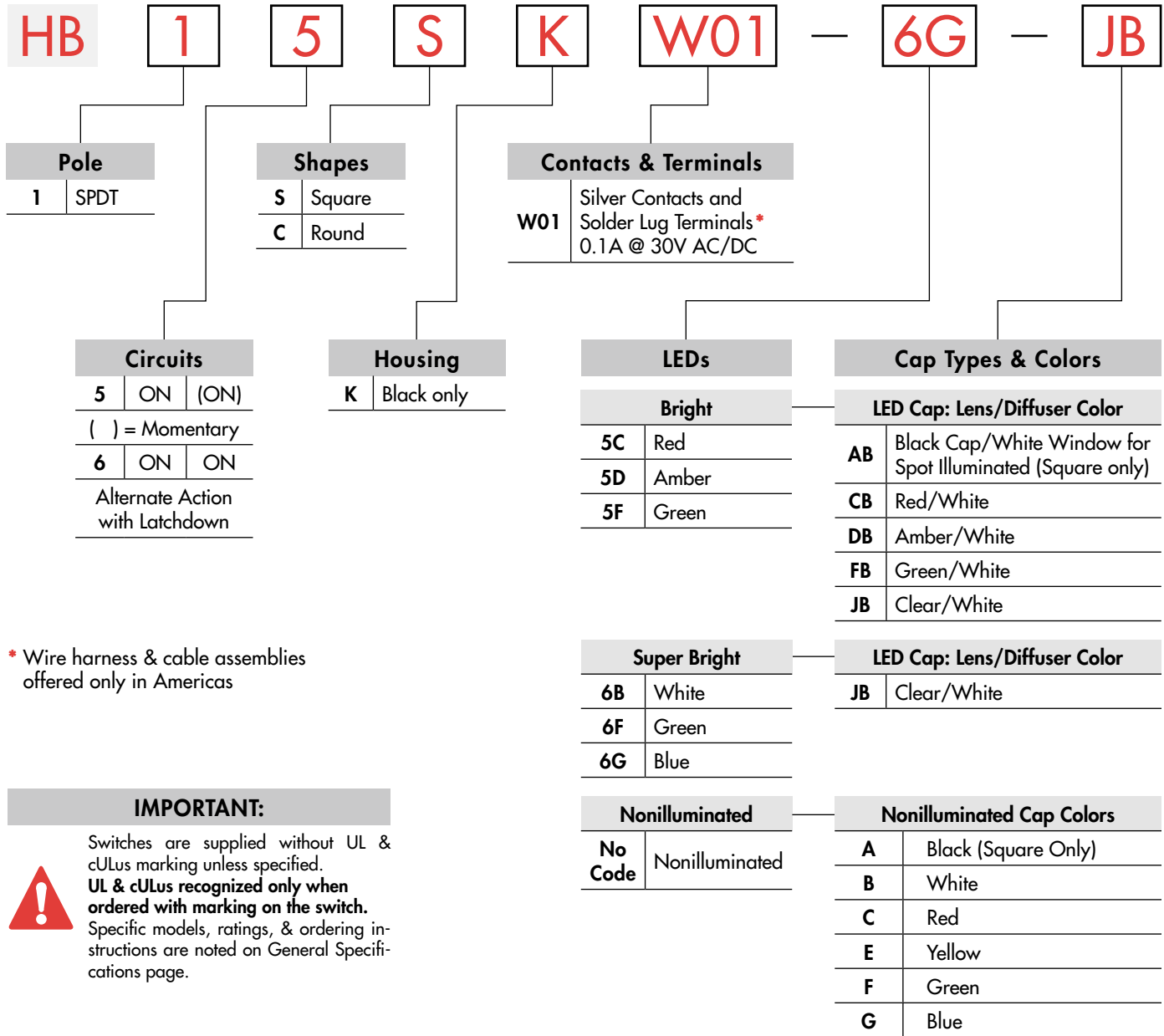

#### IMPORTANT:





Switches are supplied without UL & cULus marking unless specified.  
**UL & cULus recognized only when ordered with marking on the switch.**  
 Specific models, ratings, & ordering instructions are noted on General Specifications page.

### DESCRIPTION FOR TYPICAL ORDERING EXAMPLE

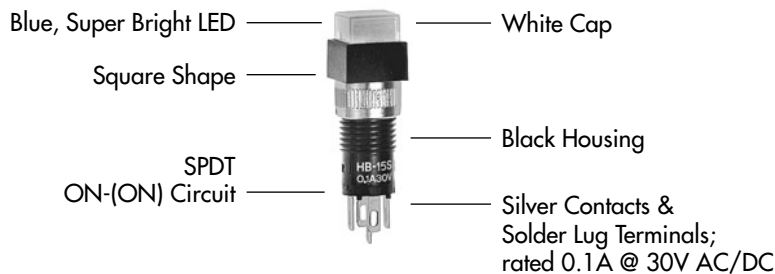
#### HB15SKW01-6G-JB



POLES & CIRCUITS						
		Plunger Position ( ) = Momentary		Connected Terminals		Throw & Switch/Lamp Schematics
Pole	Model	Normal	Down	Normal	Down	Notes: Switch is marked with NO, NC, C, L. LED circuit is isolated and requires external power source.
SP	HB15 *HB16	ON ON	(ON) ON	1-3	1-2	SPDT  

\* When in latchdown position for the alternate circuit, cap position is .051" (1.3mm) above the built-in bezel.

## SHAPES & PANEL CUTOUT

**S**

.354" (9.0mm) Square

The bezel is an integral part of the switch body.

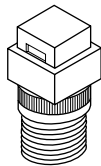

**C**

.354" (9.0mm) Round

The bezel is an integral part of the switch body.

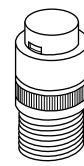

### Panel Cutout & Mounting

Recommended Panel Thickness:  
.020 ~ .197" (0.5 ~ 5.0mm)

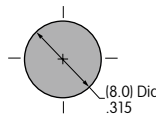

Overtightening the mounting nut AT073 may damage the switch housing.

## HOUSING

**K**

Housing available in black only.

## CONTACT MATERIALS, RATINGS, & TERMINALS

**W01**

Silver Contacts

Power Level

0.1A maximum @ 30V AC/DC

Solder Lug

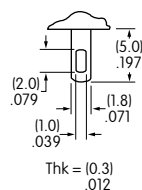



PCB Mounting

Solder lug terminals are spaced .100" x .200" (2.54mm x 5.08mm). This enables PCB mounting which can be accomplished by elongating PC board holes to .080" (2.03mm).

Toggles  
Rockers  
Pushbuttons  
Illuminated PB  
Programmable  
Keylocks  
Rotaries  
Slides  
Tactiles  
Tilt  
Touch  
Indicators  
Accessories  
Supplement

## LED COLORS & SPECIFICATIONS

The electrical specifications shown are determined at a basic temperature of 25°C.  
 LED circuit is isolated and requires external power source. Single element LED is colored in OFF state.  
 If the source voltage exceeds the rated voltage, a ballast resistor is required.  
 The resistor value can be calculated by using the formula in the Supplement section.

Bright AT633		Note for Super Bright: 	Bright			Super Bright			Unit	
			5C	5D	5F	6B	6F	6G		
Super Bright		Color	Red	Amber	Green	White	Green	Blue		
AT624G Blue		Forward Peak Current	$I_{FM}$	30	30	25	30	30	30	mA
AT629B White		Typical Forward Current	$I_F$	20	20	20	20	20	20	mA
AT630F Green		Forward Voltage	$V_F$	1.85	2.0	2.2	3.6	3.5	3.6	V
		Reverse Peak Voltage	$V_{RM}$	5	5	5	5	5	5	V
		Current Reduction Rate Above 25°C	$\Delta I_F$	0.40	0.42	0.38	0.50	0.50	0.50	mA/°C
T-1 Bi-pin	Ambient Temperature Range		-25° ~ +50°C			-25° ~ +50°C				

**No Code**

No Lamp

## CAP TYPES & COLORS

Color Codes: A Black B White C Red D Amber E Yellow F Green G Blue J Clear

### Cap Colors Available:

**AB** Black Cap with Translucent White Window for LED Display

### Colored Cap for Bright LEDs

Square only  
 Material: Polycarbonate  
 Finish: Matte

**AT4052**  
 Spot Illuminated

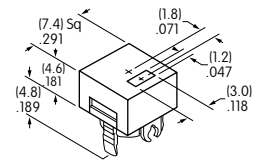

### Lens/Diffuser Colors Available:

**CB** Red/White

**DB** Amber/White

**FB** Green/White

**AT4166**  
 Square

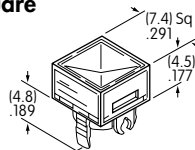

**AT4167**  
 Round

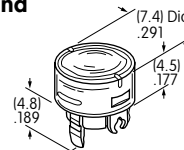

Material: Polycarbonate Finish: Glossy

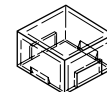

Transparent Colored Lens



Translucent White Diffuser



Colored LED AT633

### White Cap for Bright & Super Bright LEDs

**JB** Clear Lens/White Diffuser

Material: Polycarbonate  
 Finish: Glossy

**AT4031**  
 Square

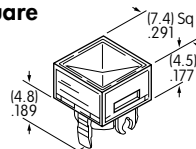

**AT4032**  
 Round

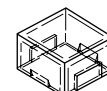
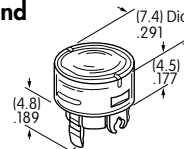

Transparent Clear Lens



Translucent White Diffuser



Colored LEDs AT624, AT629, AT630, or AT633

### Nonilluminated Caps

#### Cap Colors Available:

**A** Black (Square Only)

**B** White

**C** Red

**E** Yellow

**F** Green

**G** Blue

Material: Polycarbonate Finish: Glossy

**AT4035**  
 Square

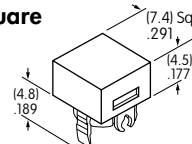

**AT4036**  
 Round

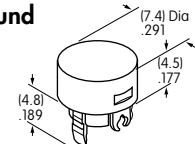

TYPICAL SWITCH DIMENSIONS

Single Pole

Square

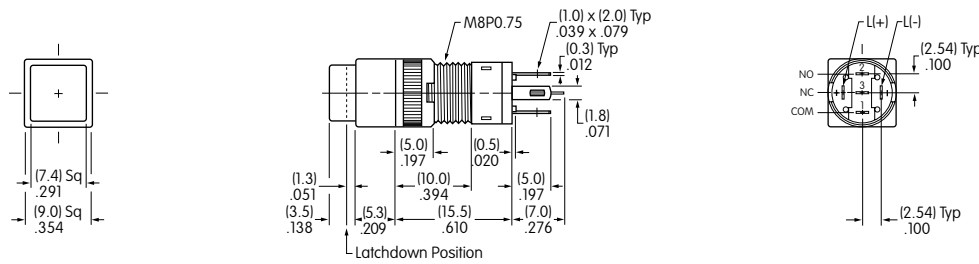

HB155KW01-5C-CB

Single Pole

Round

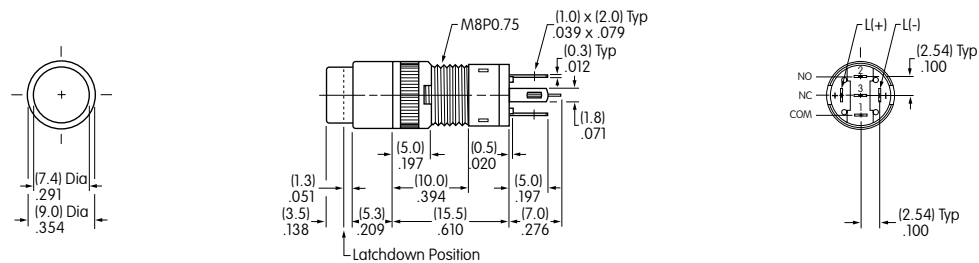

HB166KW01-5C-CB

ASSEMBLY INSTRUCTIONS

Cap Removal

1. Have cap in extended position (not latchdown) for alternate action models.
2. Use the grip slots on the sides of the cap and pull it out of the switch.

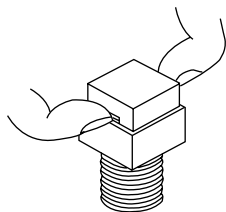

LED Polarity & Orientation in Lamp Socket

For AT624, AT629, AT630: Insert the LED with the D flat opposite the black dot molded inside the switch lamp socket. For AT633: Insert the LED with the Black Dot on the terminal to the right.

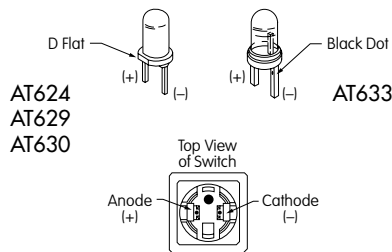

Super Bright LEDs AT624, AT629, & AT630 are electrostatic sensitive.

Cap Replacement

1. Match the prongs on the cap base with the projections in the switch, at the same time aligning the spring clips on the cap with the indentations in the switch.
2. Press firmly in place.

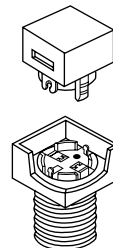

AT111 Lamping Tool

Lamping Tool AT111 may be used to remove and replace LED.



AT110 Socket Wrench

Socket Wrench AT110 may be used to tighten the mounting nut.





Компания «ЭлектроПласт» предлагает заключение долгосрочных отношений при поставках импортных электронных компонентов на взаимовыгодных условиях!

Наши преимущества:

- Оперативные поставки широкого спектра электронных компонентов отечественного и импортного производства напрямую от производителей и с крупнейших мировых складов;
- Поставка более 17-ти миллионов наименований электронных компонентов;
- Поставка сложных, дефицитных, либо снятых с производства позиций;
- Оперативные сроки поставки под заказ (от 5 рабочих дней);
- Экспресс доставка в любую точку России;
- Техническая поддержка проекта, помощь в подборе аналогов, поставка прототипов;
- Система менеджмента качества сертифицирована по Международному стандарту ISO 9001;
- Лицензия ФСБ на осуществление работ с использованием сведений, составляющих государственную тайну;
- Поставка специализированных компонентов (Xilinx, Altera, Analog Devices, Intersil, Interpoint, Microsemi, Aeroflex, Peregrine, Syfer, Eurofarad, Texas Instrument, Miteq, Cobham, E2V, MA-COM, Hittite, Mini-Circuits, General Dynamics и др.);

Помимо этого, одним из направлений компании «ЭлектроПласт» является направление «Источники питания». Мы предлагаем Вам помощь Конструкторского отдела:

- Подбор оптимального решения, техническое обоснование при выборе компонента;
- Подбор аналогов;
- Консультации по применению компонента;
- Поставка образцов и прототипов;
- Техническая поддержка проекта;
- Защита от снятия компонента с производства.



#### Как с нами связаться

**Телефон:** 8 (812) 309 58 32 (многоканальный)

**Факс:** 8 (812) 320-02-42

**Электронная почта:** [org@eplast1.ru](mailto:org@eplast1.ru)

**Адрес:** 198099, г. Санкт-Петербург, ул. Калинина, дом 2, корпус 4, литера А.