

## ELVR - Analog and Digital Low Pressure Sensors Series

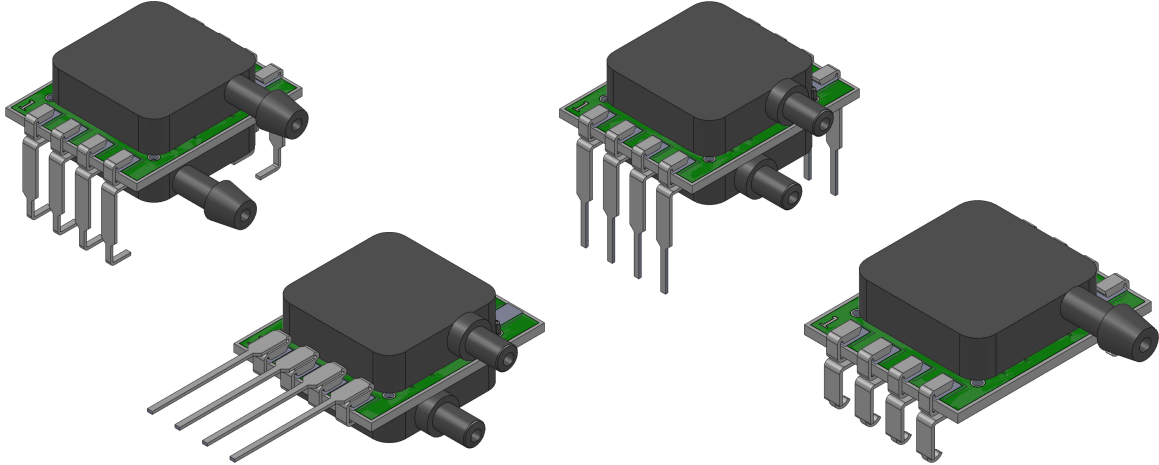

### Table of Contents

<a href="#">Features &amp; Applications</a> .....	2
<a href="#">Standard Pressure Ranges</a> .....	2
<a href="#">Pressure Sensor Maximum Ratings</a> .....	2
<a href="#">Environmental Specifications</a> .....	2
<a href="#">Analog Output (5V) Specifications</a> .....	3
<a href="#">Analog Output (3V) Specifications</a> .....	4
<a href="#">Digital Output (5V) Specifications</a> .....	5
<a href="#">Digital Output (3V) Specifications</a> .....	6
<a href="#">Device Option Descriptions</a> .....	7
<a href="#">I<sup>2</sup>C Interface</a> .....	8-9
<a href="#">SPI Interface</a> .....	10-11
<a href="#">How to Order Guide</a> .....	12
<a href="#">Dimensional Package Drawings</a>	
<a href="#">Non-Barbed SIL, DIP and SMT</a> ....	13-16
<a href="#">Barbed SIL, DIP and SMT</a> .....	17-20
<a href="#">Product Labeling</a> .....	21
<a href="#">Suggested Pad Layouts</a> .....	21

### Introduction

The ELVR Series Mini Analog and Digital Output Sensor is based on All Sensors' CoBeam<sup>2</sup>™ Technology. This reduces package stress susceptibility, resulting in improved overall long term stability. The superior dual-die technology also vastly improves position sensitivity compared to single die devices. This technology breakthrough advances the state of the art for piezoresistive pressure sensors beyond what has been achieved for low pressure sensing using silicon based strain technology.

The ELVR sensors can communicate directly with microcontrollers, eliminating the need for additional A/D converters. ELVR series pressure sensors are available at 3V and 5V supply voltage. The ELVR series provides a rapid update rate at multiple resolutions. A wide range of miniature SIP and DIP package options allows for flexible and space-saving PCB-mounting. These calibrated and compensated sensors provide accurate, stable output over a wide temperature range. This series is intended for use with non-corrosive, non-ionic working fluids such as air and dry gases. A protective parylene coating is optionally available for moisture/harsh media protection for pressure ranges 10 inH<sub>2</sub>O and above.

The ELVR Series is a direct replacement to First Sensors' HCLA product line. Refer to the product web page for a cross reference table:

<https://www.allensors.com/products/elvr-series>



# ELVR SERIES ANALOG & DIGITAL PRESSURE SENSORS

## Features

- Pressure Ranges from 2.5 mbar to 75 mbar (1 to 30 inH2O)
- Precision ASIC Conditioning
- Analog Output with Digital I2C and SPI Interface
- 3V and 5V Supply Voltage

## Applications

- Medical
- Industrial

## Standard Pressure Ranges

Device	Operating Range <sup>A</sup>		Differential Proof Pressure		Differential Burst Pressure	
	mbar	inH2O	mbar	inH2O	mbar	inH2O
ELVR-L01D	± 2.5	± 1	250	100	750	301
ELVR-L05D	± 12.5	± 5	500	201	750	301
ELVR-L10D	± 25	± 10	500	201	750	301
ELVR-L20D	± 50	± 20	500	201	1250	502
ELVR-L30D	± 75	± 30	500	201	2000	803
ELVR-L01G	2.5	1	250	100	750	301
ELVR-L05G	12.5	5	500	201	750	301
ELVR-L10G	25	10	500	201	750	301
ELVR-L20G	50	20	500	201	1250	502
ELVR-L30G	75	30	500	201	2000	803

Note A: Operating range in inH2O is expressed as an approximate value. ELVR series is calibrated to mbar pressure units.

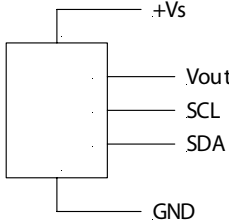
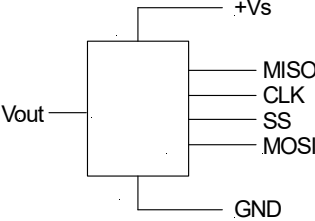
Pressure Sensor Maximum Ratings		Environmental Specifications	
<b>Supply Voltage (Vs)</b>	2.7 to 5.5 Vdc	<b>Temperature Ranges</b>	
<b>Analog-Output Current</b>		Compensated:	Commercial 0°C to 70°C Industrial -20°C to 85°C
Sink	1 mA	Operating	-25°C to 85°C
Source	1 mA	Storage	-40°C to 125°C
<b>Common Mode Pressure</b>	2000 mbar / 803 inH2O	<b>Humidity Limits (non condensing)</b>	0 to 95% RH
SMT Assembly Specifications		Equivalent Circuit	
<b>Average preheating temperature gradient</b>	2.5 K/s	<b>I2C</b>	<b>SPI</b>
<b>Soak Time</b>	ca. 3 min		
<b>Time above 217°C</b>	50 s	See package drawings for pinouts.	
<b>Time above 230°C</b>	40 s		
<b>Time above 250°C</b>	15 s		
<b>Peak Temperature</b>	260°C		
<b>Cooling Temperature Gradient</b>	-3.5 K/s		



## Performance Characteristics for ELVR Series Amplified Low Pressure Sensors

All parameters are measured at **5.0 volt** excitation and 25°C unless otherwise specified. Pressure measurements are with positive pressure applied to PORT B

Analog Performance Characteristics						
Parameter		Minimum	Nominal	Maximum	Units	Specification Notes
Full Scale Span (FSS)		3.9	4.0	4.1	V	5
Full Scale Output (FSO)						-
	Min Pressure		0.25		V	
	Max Pressure		4.25		V	
Span Temperature Shift						
	L01x	-	-	±2	%FSS	2
	L05x through L30x	-	-	±1	%FSS	2
Offset Voltage @ zero differential pressure						
	LxxD	2.15	2.25	2.35	V	-
	LxxG	0.15	0.25	0.35	V	-
Offset Temperature Shift						
	L01x	-	-	±1.5	%FSS	2
	L05x	-	-	±1	%FSS	2
	L10x through L30x	-	-	±0.5	%FSS	2
Offset Warm-up Shift						
	L01x	-	±10	-	mV	3
	L05x through L30x	-	±5	-	mV	3
Offset Long Term Drift (one year)						
	L01x	-	±15	-	mV	-
	L05x through L30x	-	±5	-	mV	-
Linearity, Hysteresis error (all products)		-	±0.05	±0.25	%FSS	4
Response Delay		-	0.5	-	ms	1
D/A Resolution		-	-	11	bit	-
Current Consumption (no load)		-	5.0	-	mA	6

### Specification Notes

**Note 1:** For any pressure applied the output response time to reach 90% of pressure applied.

**Note 2:** Shift is relative to 25°C between standard or industrial compensated temperature range endpoints.

**Note 3:** Shift is within the first hour of excitation applied to the device.

**Note 4:** Measured at one-half full scale rated pressure using best straight line curve fit.

**Note 5:** The span is the algebraic difference between full scale output voltage and the offset voltage.

**Note 6:** Parameter is characterized and not 100% tested.

## Performance Characteristics for ELVR Series Amplified Low Pressure Sensors

All parameters are measured at **3.0 volt** excitation and 25°C unless otherwise specified. Pressure measurements are with positive pressure applied to PORT B

Analog Performance Characteristics						
Parameter		Minimum	Nominal	Maximum	Units	Specification Notes
Full Scale Span (FSS)		1.9	2.0	2.10	V	5
Full Scale Output (FSO)						-
	Min Pressure		0.25		V	
	Max Pressure		2.25		V	
Span Temperature Shift						
	L01x	-	-	±2	%FSS	2
	L05x through L30x	-	-	±1	%FSS	2
Offset Voltage @ zero differential pressure						
	LxxD	1.15	1.25	1.35	V	-
	LxxG	0.15	0.25	0.35	V	-
Offset Temperature Shift						
	L01x	-	-	±1.5	%FSS	2
	L05x	-	-	±1	%FSS	2
	L10x through L30x	-	-	±0.5	%FSS	2
Offset Warm-up Shift						
	L01x	-	±10	-	mV	3
	L05x through L30x	-	±5	-	mV	3
Offset Long Term Drift (one year)						
	L01x	-	±5	-	mV	-
	L05x through L30x	-	±5	-	mV	-
Linearity, Hysteresis error (all products)		-	±0.05	±0.25	%FSS	4
Response Delay		-	0.5	-	ms	1
D/A Resolution		-	-	11	bit	-
Current Consumption		-	5	-	mA	6

## Performance Characteristics for ELVR Series Amplified Low Pressure Sensors

All parameters are measured at **5.0 volt** excitation and 25°C unless otherwise specified. Pressure measurements are with positive pressure applied to PORT B

### Digital Performance Characteristics in Decimal

Parameter	Minimum	Nominal	Maximum	Units	Specification Notes
<b>Full Scale Span (FSS)</b>	-	26214	-	Decimal	2
<b>Full Scale Output (FSO)</b>					
Min Pressure		1638		Decimal	5
Max Pressure		27852		Decimal	5
<b>Span Temperature Shift</b>					
L01x	-	-	±2	%FSS	2
L05x through L30x	-	-	±1	%FSS	2
<b>Offset Voltage @ zero differential pressure</b>					
LxxD	14090	14745	15400	Decimal	-
LxxG	983	1638	2294	Decimal	-
<b>Offset Temperature Shift</b>					
L01x	-	-	±1.5	%FSS	2
L05x	-	-	±1	%FSS	2
L10x through L30x	-	-	±0.5	%FSS	2
<b>Offset Warm-up Shift</b>					
L01x	-	66	-	Decimal	3
L05x through L30x	-	33	-	Decimal	3
<b>Offset Position Sensitivity (±1 g)</b>					
L01x	-	99	-	Decimal	-
L05x through L30x	-	33	-	Decimal	-
<b>Offset Long Term Drift (one year)</b>					
L01x	-	66	-	Decimal	-
L05x through L30x	-	33	-	Decimal	-
<b>Linearity, Hysteresis error (all products)</b>	-	±0.05	±0.25	%FSS	4
<b>Response Delay</b>		0.5		ms	1
<b>A/D Resolution</b>	-	12	-	bit	-
<b>Current Consumption</b>	-	5	-	mA	6

## Performance Characteristics for ELVR Series Amplified Low Pressure Sensors

All parameters are measured at **3.0 volt** excitation and 25°C unless otherwise specified. Pressure measurements are with positive pressure applied to PORT B

### Digital Performance Characteristics in Decimal

Parameter	Minimum	Nominal	Maximum	Units	Specification Notes
<b>Full Scale Span (FSS)</b>	21299	21845	22391	Decimal	2
<b>Full Scale Output (FSO)</b>					
Min Pressure	-	2731	-	Decimal	5
Max Pressure	-	24576	-	Decimal	5
<b>Span Temperature Shift</b>					
L01x	-	-	±2	%FSS	2
L05x through L30x	-	-	±1	%FSS	2
<b>Offset Voltage @ zero differential pressure</b>					
LxxD	12561	13653	14745	Decimal	-
LxxG	1638	2731	3823	Decimal	-
<b>Offset Temperature Shift</b>					
L01x	-	-	±1.5	%FSS	2
L05x	-	-	±1	%FSS	2
L10x through L30x	-	-	±0.5	%FSS	2
<b>Offset Warm-up Shift</b>					
L01x	-	66	-	Decimal	3
L05x through L30x	-	33	-	Decimal	3
<b>Offset Position Sensitivity (±1 g)</b>					
L01x	-	99	-	Decimal	-
L05x through L30x	-	33	-	Decimal	-
<b>Offset Long Term Drift (one year)</b>					
L01x	-	66	-	Decimal	-
L05x through L30x	-	33	-	Decimal	-
<b>Linearity, Hysteresis error (all products)</b>	-	±0.05	±0.25	%FSS	4
<b>Response Delay</b>	-	0.5	-	ms	1
<b>A/D Resolution</b>	-	12 or 14	-	bit	-
<b>Current Consumption</b>	-	5	-	mA	6



---

## Device Options

---

The following is a list of factory programmable options. Consult the factory to learn more about the options.

### Interface

I2C and SPI interfaces are available with eight (8) lead packages only.

### Supply Voltage

Devices are characterized at either 3.0V or 5.0V depending on the options selected. It is suggested to select the option that most closely matches the application supply voltage for best possible performance.

### Speed/Power

There are two options of Speed/Power. These are Fast(F) and High Resolution(H).

Fast Mode(F) Is the fastest operating mode where the device operates with continuous sampling at the fastest internal speed 12 bit resolution, 0.5ms update rate.

High Resolution(H): Also operates with continuous samples however the ADC is set for longer duration for higher resolution. The conversion times are resultantly longer than the Fast(F) mode with 1 ms update rate.

### Coating

Parylene Coating: Parylene coating provides a moisture barrier and protection form some harsh media. Consult factory for applicability of Parylene for the target application and sensor type. This option is not available for pressure ranges below 10 inH2O.

# I2C Interface

## Introduction

The ELVR is capable of producing a digital output signal. The device runs a cyclic program, which will store a corrected pressure value with 12 or 13 bit resolution about every 250µs within the output registers of the internal ASIC. In order to use the sensor for digital signal readout, it should be connected to a bidirectional I2C-bus.

According to the I2C-bus specification, the bus is controlled by a master device, which generates the clock signal, controls the bus access and generates START and STOP conditions. The ELVR is designed to work as a slave, hence it will only respond to requests from a master device.

## Digital I2C interface

The ELVR complies with the following protocol in Figure 1.

**Bus not busy** : During idle periods both data line (SDA) and clock line (SCL) remain HIGH.

**START condition (S)** : HIGH to LOW transition of SDA line while clock (SCL) is HIGH is interpreted as START condition. START conditions are always generated by the master. Each initial request for a pressure value has to begin with a START condition.

**STOP condition (P)** : LOW to HIGH transition of SDA line while clock (SCL) is HIGH determines STOP condition. STOP conditions are always generated by the master. More than one request for the current pressure value can be transmitted without generation of intermediate STOP condition.

**DATA valid (D)**: State of data line represents valid data when, after START condition, data line is stable for duration of HIGH period of clock signal. Data on line must be changed during LOW period of clock signal. There is one clock pulse per bit of data.

**Acknowledge (A)**: Data is transferred in pieces of 8 bits (1 byte) on serial bus, MSB first. After each byte the receiving device – whether master or slave – is obliged to pull data line LOW as acknowledge for reception of data. Master must generate an extra clock pulse for this purpose. When acknowledge is missed, slave transmitter becomes inactive. Master must then either send last command again or generate STOP condition in that case.

**Slave address**: The I2C-bus master-slave concept requires a unique address for each device. The ELVR has a preconfigured slave address, see table 2. The sensor will then listen to both slave addresses. After generating a START condition the master sends the address byte containing a 7 bit address followed by a data direction bit (R/W). A "0" indicates a transmission from master to slave (WRITE), a "1" indicates a data request (READ).

**DATA operation** : The sensor starts to send 2 data bytes containing the current pressure value as a 15 bit value placed in the output registers.

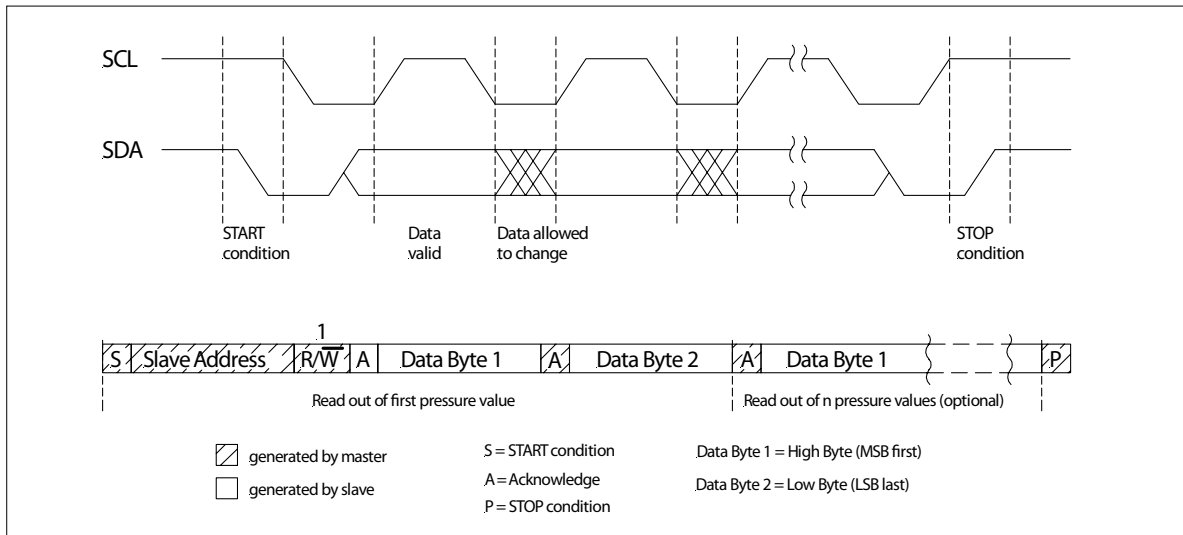

Figure 1: I<sup>2</sup>C bus protocol



## I<sup>2</sup>C BUS INTERFACE (Cont'd)

### I<sup>2</sup>C Interface Parameters

Parameter	Symbol	Minimum	Nominal	Maximum	Unit
Input High Level	-	90	-	100	% of V <sub>s</sub>
Input Low Level	-	0	-	10	% of V <sub>s</sub>
Output Low Level	-	-	-	10	% of V <sub>s</sub>
Pull-Up Resistor	-	500	-	-	Ω
Load Capacitance @ SDA	C <sub>SDA</sub>	-	-	400	pF
Input Capacitance @ SDA/SCL	C <sub>I2C_IN</sub>	-	-	10	pF
Signal Clock Frequency	F <sub>SCL</sub>	100*	-	400	kHZ
Bus Free Time Between STOP and START Condition	t <sub>BUF</sub>	1.3	-	-	μs
Hold Time (Repeated) START Condition, to First Clock Pulse	t <sub>HD,STA</sub>	0.8	-	-	μs
Low Period of SCL	t <sub>Low</sub>	1.3	-	-	μs
High Period of SCL	t <sub>High</sub>	0.6	-	-	μs
Setup Time Repeated START Condition	t <sub>SU,STA</sub>	1	-	-	μs

**Note:** All Sensors recommends communication speeds of at least 100 kHz (max. 640 kHz). Please contact your nearest All Sensors sales office for further information.

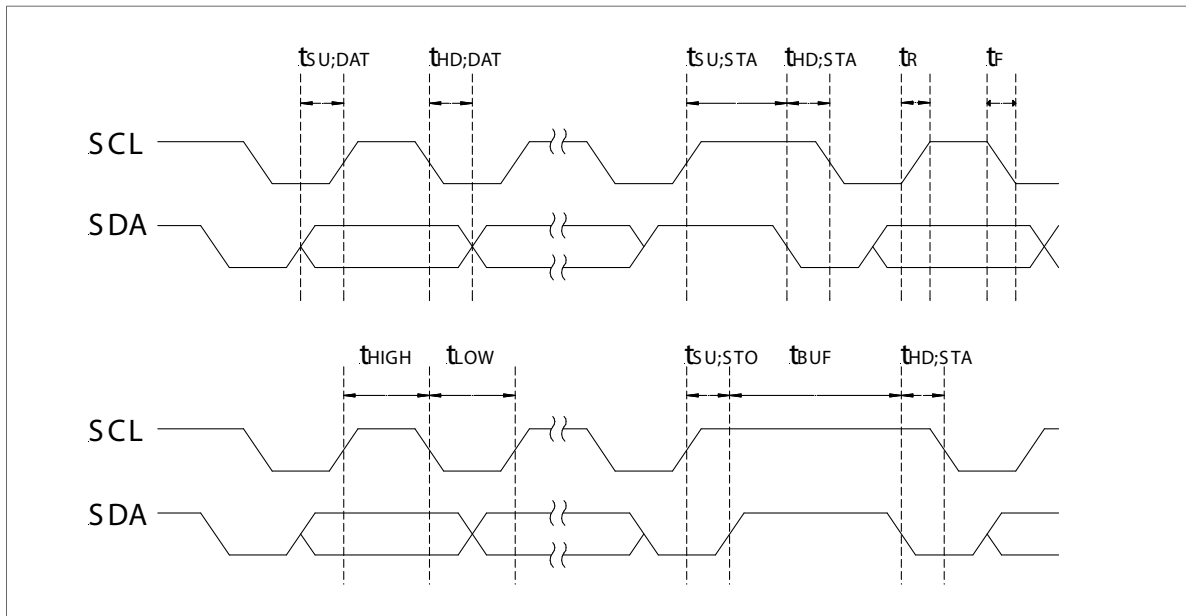

Figure 2. Timing Characteristics

# SPI - SERIAL PERIPHERAL INTERFACE

## Introduction

The ELVR series is capable of producing a digital output signal. The device runs a cyclic program, which will store a corrected sensor value with 12 or 13 bit resolution about every 9 ms within the output registers of the internal ASIC. This cyclic program runs independent from the bus communication. In order to use the pressure sensor for digital signal readout, it should be connected to a SPI Master device.

SPI specifies four signals: The clock (CLK) is generated by the master and input to all slaves. MOSI carries data from master to slave. MISO carries data from slave back to master. A slave select line (SS) allows individual selection of a slave device.

## SPI Modes

A pair of parameters called clock polarity (CPOL) and clock phase (CPHA) determine the edges of the clock signal on which the data are driven and sampled. Each of the two parameters has two possible states, which allows for four possible combinations, all of which are incompatible with one another.

The ELVR series supports all clock phase (CPHA)=0 and polarity (CPOL)=0. CPOL which means that data transmission starts with the rising first clock edge (see Figure 3).

## Slave select

The falling edge of the SS line indicates the beginning of the transfer. Additionally the SS line must not be negated and reasserted between the three bytes to be transmitted.

## Data operation

The MOSI line should always be set to high level. So there is no data transmission from master to slave. Because of internal configuration the slave will answer the first byte with an FFxh. The second and third byte contain the 15 bit pressure information (see Figure 4).

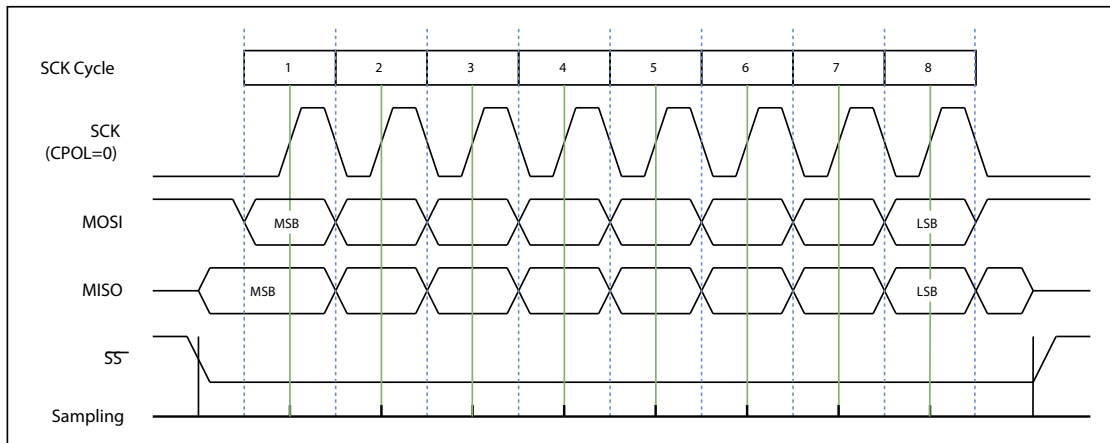

Figure 3: Example of a standard 1 byte SPI data transfer for CPHA=0 and CPOL=0

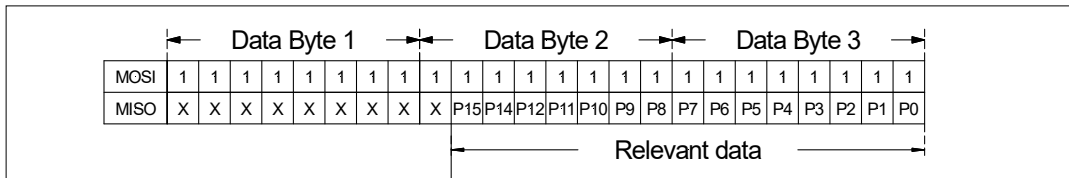

Figure 4: 3 byte data stream between ELVR sensor and master containing the pressure value as a 15 bit value.



## SPI - SERIAL PERIPHERAL INTERFACE (Cont'd)

### Interface Parameters

Parameter	Symbol	Minimum	Nominal	Maximum	Unit
Input High Level	-	90	-	100	% of $V_s$
Input Low Level	-	0	-	10	% of $V_s$
Output Low Level	-	-	-	10	% of $V_s$
Pull-Up Resistor	-	500	-	-	$\Omega$
Load Capacitance @ MISO	$C_{MISO}$	-	-	400	pF
Input Capacitance @ Each Pin	$C_{SPL\_IN}$	-	-	10	pF
Signal Clock Frequency	$f_{SCK}$	100*	-	640	KHZ
MISO Hold Time after SCK Sample Slope	$t_{SPL\_HD\_MISO}$	200	-	-	ns
MOSI Setup Time Before SCK Sample Slope	$t_{SPL\_SU\_MOSI}$	$2/f_{CLK}$	-	-	-
/SS Setup Time Before SCK Sample Slope	$t_{SPL\_SU\_SS}$	10	-	-	ns
/SS Hold Time After SCK Sample Slope	$t_{SPL\_HD\_SS}$	$1/f_{CLK}$	-	-	-

**Note:** All Sensors recommends communication speeds of at least 100 kHz (max. 640 kHz). Please contact your nearest All Sensors sales office for further information.

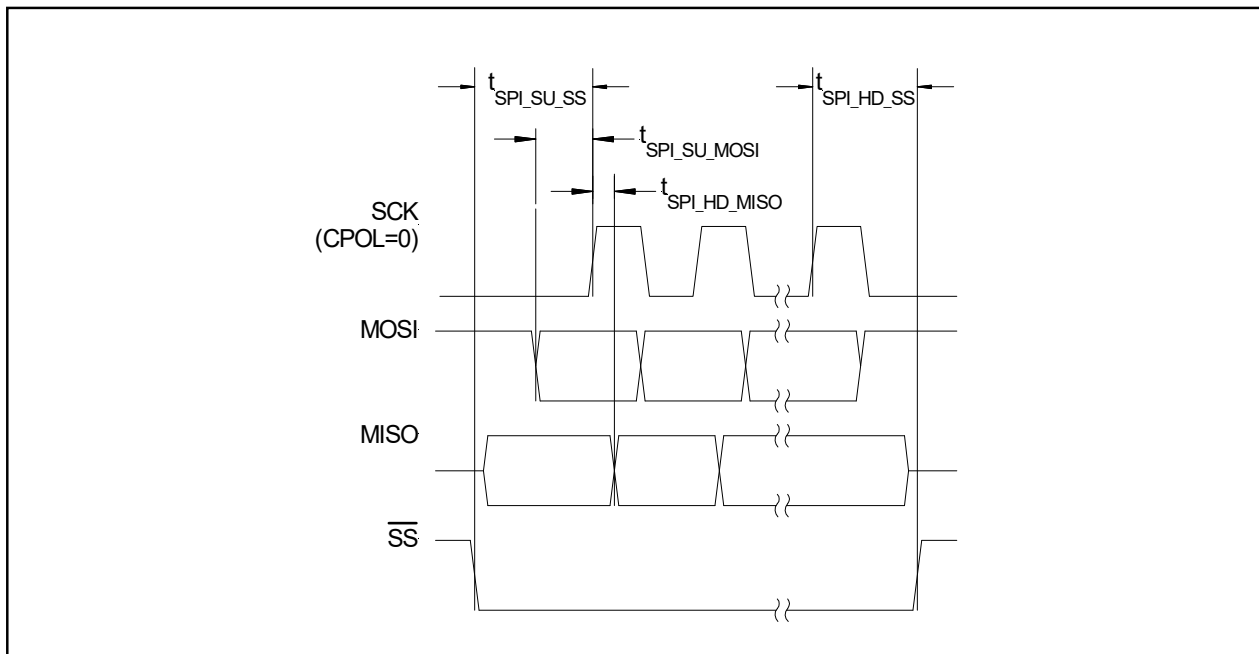

Figure 5: Timing characteristics

## How to Order

Refer to Table 1 for configuring a standard base part number which includes the pressure range, package and temperature range. Table 2 shows the available configuring options. The option identifier is required to complete the device part number. Refer to Table 3 for the available device package options.

Example P/N with options: ELVR-L01D-F1RS-C-NI3F



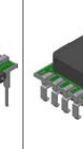
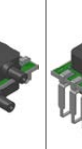



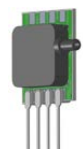

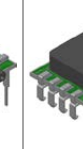
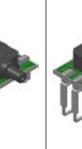
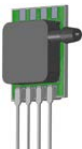

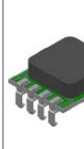

Table 1 - How to configure a base part number

ORDERING INFORMATION	SERIES		PRESSURE RANGE		PACKAGE			TEMPERATURE RANGE				
	ID	Description	ID	Description	Base	Port Orientation	Lid Style	Lead Type	ID	Description		
	ELVR	L01D	±1 inH2O	L05D	±5 inH2O	F	1	Dual Port Same Side	R	T	SIL (see note 7)	C
			L10D	±10 inH2O		N	Single Port	S	D	DIP	I	Industrial
			L20D	±20 inH2O					J	J-Lead SMT		
			L30D	±30 inH2O					L	L-Lead SMT		
			L01G	0 to 1 inH2O								
			L05G	0 to 5 inH2O								
			L10G	0 to 10 inH2O								
			L20G	0 to 20 inH2O								
			L30G	0 to 30 inH2O								
Example	ELVR	-	L01D	-	F	1	-	R	-	S	-	C

Table 2 - How to configure an option identifier

ORDERING INFORMATION	COATING		INTERFACE			SUPPLY VOLTAGE		DIGITAL RESOLUTION, UPDATE RATE	
	ID	Description	ID	Description	Address	ID	Description	ID	Description
	N	No Coating	A	Analog Only (see note 7)	N/A	3	3.0V	F	Fast Mode (12bit, 0.5ms)
P	Parylene Coating (see note 8)	I	I2C & Analog	0x78	5	5.0V	H	High Resolution (14bit, 1ms)	
		S	Option- SPI & Analog	N/A					
		2	Option- I2C & Analog	0x28					
		3	Option- I2C & Analog	0x38					
		4	Option- I2C & Analog	0x48					
		5	Option- I2C & Analog	0x58					
		6	Option- I2C & Analog	0x68					
Example	N	-	I	-	-	3	-	F	

TABLE 3: Available F-Series Package Configurations

Port Orientation	Non-Barbed Lid Lead Style				Barbed Lid Lead Style			
	SIL	DIP	SMT-J	SMT-L	SIL	DIP	SMT-J	SMT-L
Dual Port Same Side	 F1RT	 F1RD	 F1RJ	 F1RL	 F1ST	 F1SD	NOT OFFERED	 F1SL
Single Port	 FNRT	 FNRD	 FNRJ	 FNRL	 FNST	 FNSD	 FNSJ	 FNLS

### Specification Notes (Cont.)

**NOTE 7: LEADFRAME "T" HAS ONLY ANALOG OUTPUT CAPABILITY. ALL LEAD TYPES EXCEPT FOR "T" HAVE SIMULTANEOUS DIGITAL AND ANALOG OUTPUT CAPABILITY.**

**NOTE 8: PARYLENE COATING NOT OFFERED IN J-LEAD SMT CONFIGURATION. PARYLENE COATING IS NOT OFFERED FOR PRESSURE RANGES BELOW 10 INH2O.**



## Package Drawings

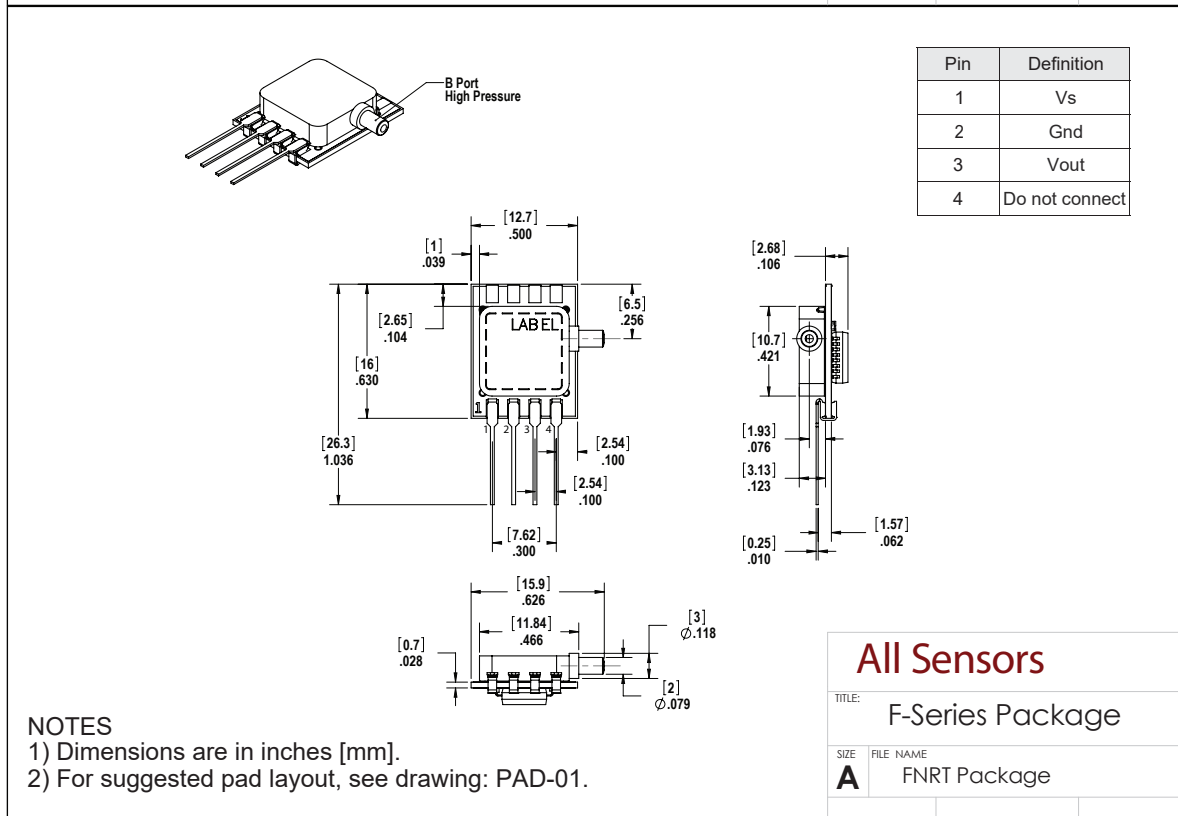
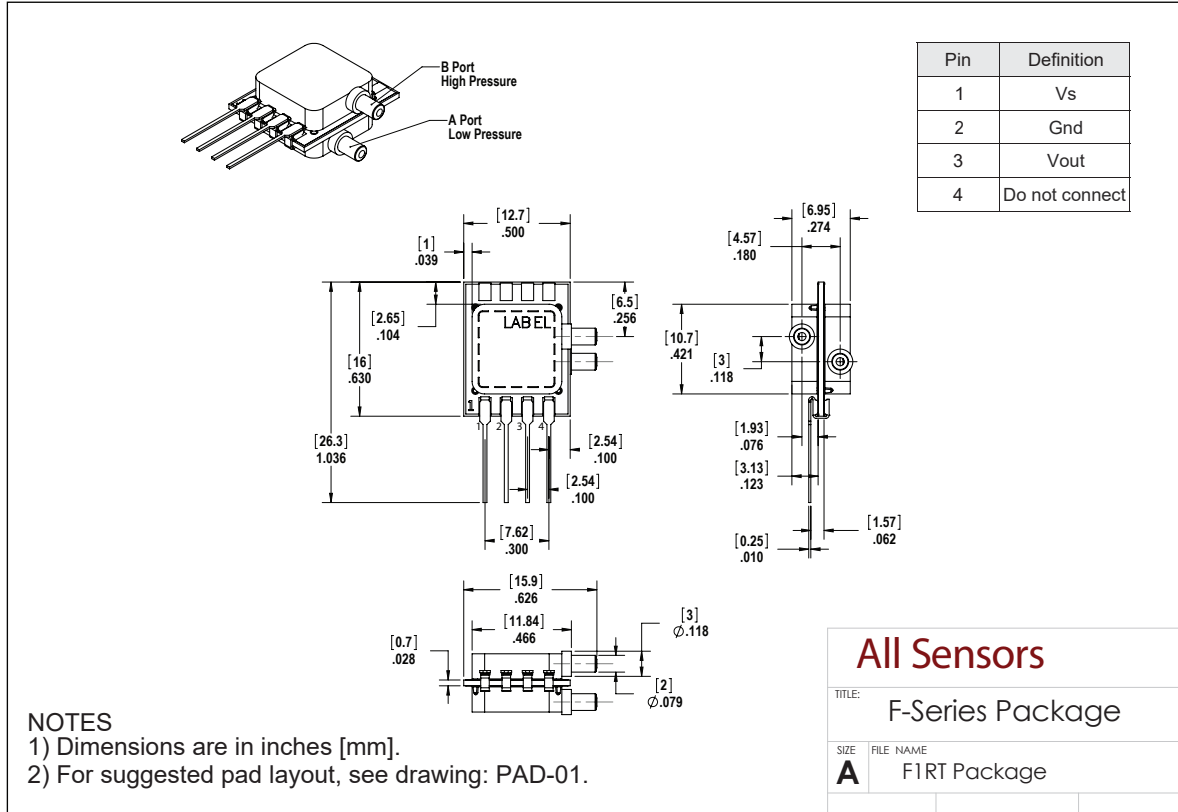

## Package Drawings (Cont'd)

	I2C	SPI
Pin	Definition	Definition
1	Vs	Vs
2	Gnd	Gnd
3	Vout	Vout
4	Do not Connect	MISO
5	SCL	CLK
6	Do not Connect	SS
7	Do not Connect	Do not Connect
8	SDA	MOSI

**NOTES**  
 1) Dimensions are in inches [mm].  
 2) For suggested pad layout, see drawing: PAD-27.

**All Sensors**  
 TITLE: F-Series Package  
 SIZE FILE NAME  
**A** FIRD Package

	I2C	SPI
Pin	Definition	Definition
1	Vs	Vs
2	Gnd	Gnd
3	Vout	Vout
4	Do not Connect	MISO
5	SCL	CLK
6	Do not Connect	SS
7	Do not Connect	Do not Connect
8	SDA	MOSI

**NOTES**  
 1) Dimensions are in inches [mm].  
 2) For suggested pad layout, see drawing: PAD-27.

**All Sensors**  
 TITLE: F-Series Package  
 SIZE FILE NAME  
**A** FNRD Package

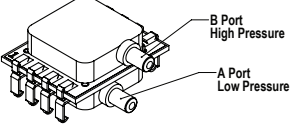
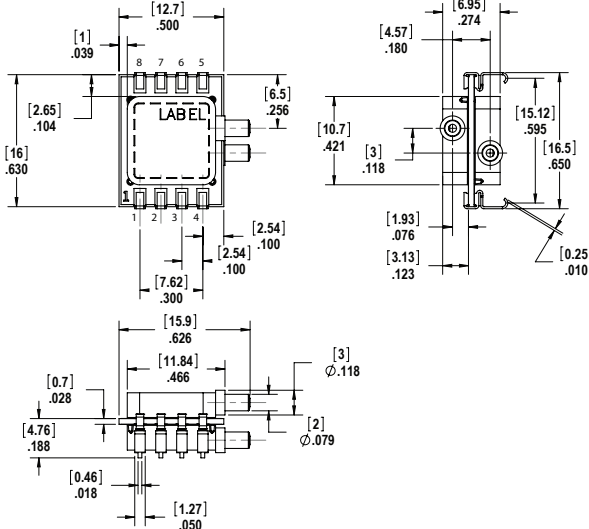

## Package Drawings (Cont'd)

	I2C	SPI
Pin	Definition	Definition
1	Vs	Vs
2	Gnd	Gnd
3	Vout	Vout
4	Do not Connect	MISO
5	SCL	CLK
6	Do not Connect	SS
7	Do not Connect	Do not Connect
8	SDA	MOSI

**NOTES**

- 1) Dimensions are in inches [mm].
- 2) For suggested pad layout, see drawing: PAD-28.

**All Sensors**

TITLE: F-Series Package

SIZE: FILE NAME  
**A** FIRJ Package

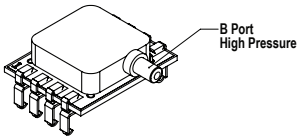
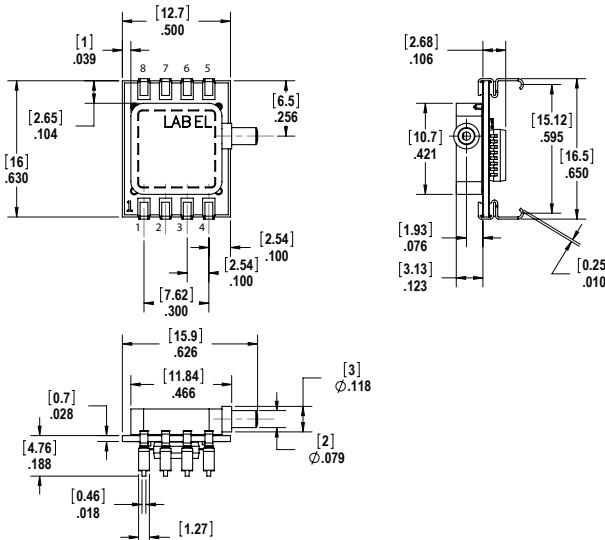
	I2C	SPI
Pin	Definition	Definition
1	Vs	Vs
2	Gnd	Gnd
3	Vout	Vout
4	Do not Connect	MISO
5	SCL	CLK
6	Do not Connect	SS
7	Do not Connect	Do not Connect
8	SDA	MOSI

**NOTES**

- 1) Dimensions are in inches [mm].
- 2) For suggested pad layout, see drawing: PAD-28.

**All Sensors**

TITLE: F-Series Package

SIZE: FILE NAME  
**A** FNRJ Package

## Package Drawings (Cont'd)

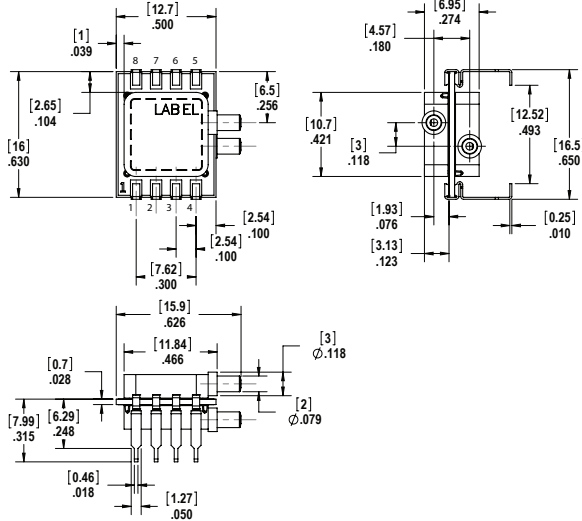
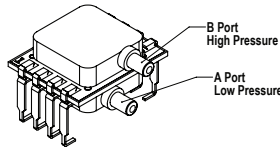

Pin	I2C	SPI
	Definition	Definition
1	Vs	Vs
2	Gnd	Gnd
3	Vout	Vout
4	Do not Connect	MISO
5	SCL	CLK
6	Do not Connect	SS
7	Do not Connect	Do not Connect
8	SDA	MOSI

### NOTES

- 1) Dimensions are in inches [mm].
- 2) For suggested pad layout, see drawing: PAD-29.

## All Sensors

TITLE: F-Series Package

SIZE FILE NAME  
**A** F1RL Package

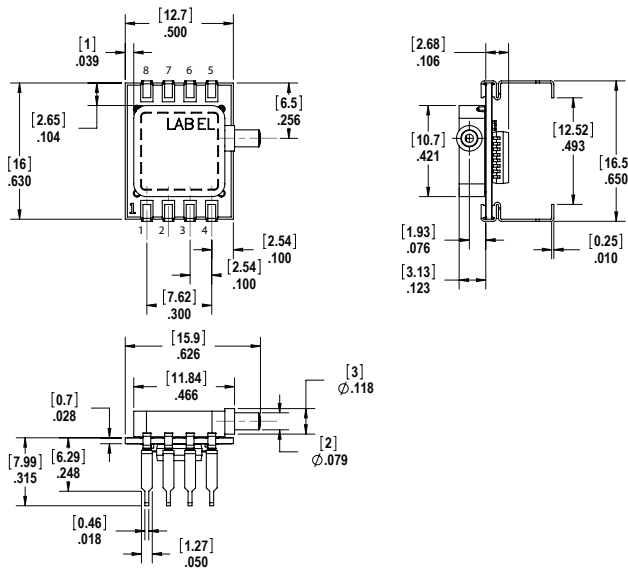
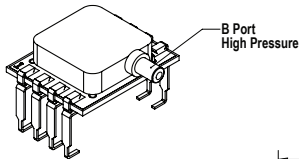

Pin	I2C	SPI
	Definition	Definition
1	Vs	Vs
2	Gnd	Gnd
3	Vout	Vout
4	Do not Connect	MISO
5	SCL	CLK
6	Do not Connect	SS
7	Do not Connect	Do not Connect
8	SDA	MOSI

### NOTES

- 1) Dimensions are in inches [mm].
- 2) For suggested pad layout, see drawing: PAD-29.

## All Sensors

TITLE: F-Series Package

SIZE FILE NAME  
**A** FNRL Package





## Package Drawings (Cont'd)

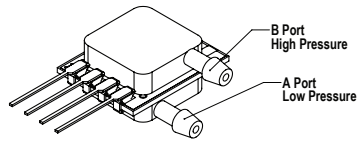

Pin	Definition
1	Vs
2	Gnd
3	Vout
4	Do not connect

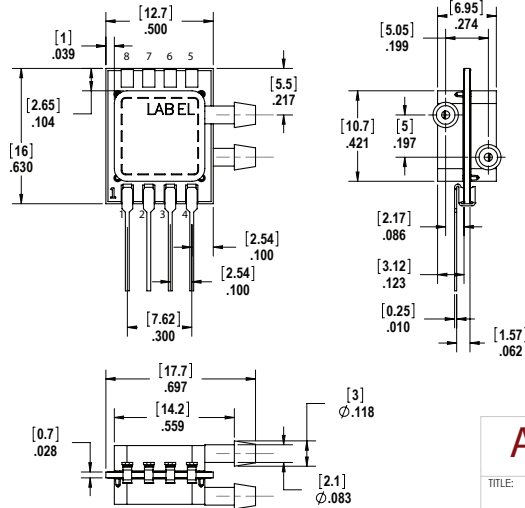

### NOTES

- 1) Dimensions are in inches [mm].
- 2) For suggested pad layout, see drawing: PAD-01.

## All Sensors

TITLE: F-Series Package

SIZE FILE NAME  
**A** F1ST Package

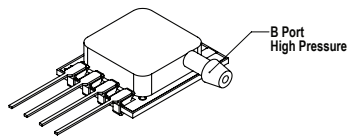

Pin	Definition
1	Vs
2	Gnd
3	Vout
4	Do not connect

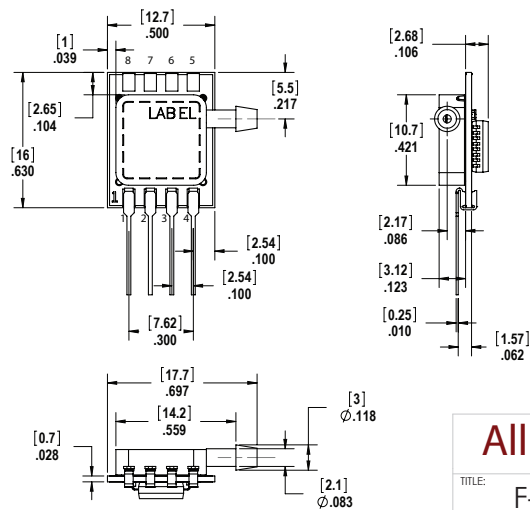

### NOTES

- 1) Dimensions are in inches [mm].
- 2) For suggested pad layout, see drawing: PAD-01.

## All Sensors

TITLE: F-Series Package

SIZE FILE NAME  
**A** FNST Package

### Package Drawings (Cont'd)

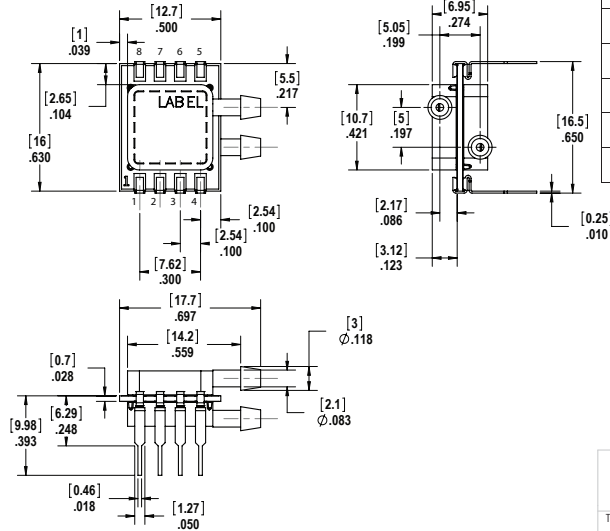
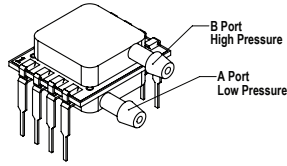

Pin	I2C	SPI
	Definition	Definition
1	Vs	Vs
2	Gnd	Gnd
3	Vout	Vout
4	Do not Connect	MISO
5	SCL	CLK
6	Do not Connect	SS
7	Do not Connect	Do not Connect
8	SDA	MOSI

**NOTES**

- 1) Dimensions are in inches [mm].
- 2) For suggested pad layout, see drawing: PAD-27.

### All Sensors

TITLE: F-Series Package

SIZE FILE NAME  
**A** F1SD Package

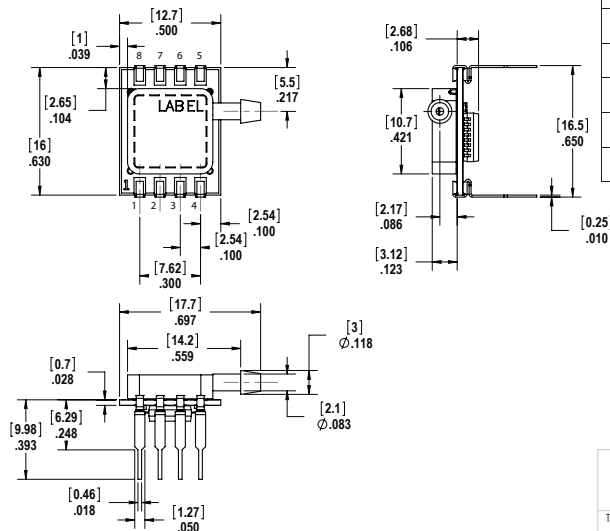
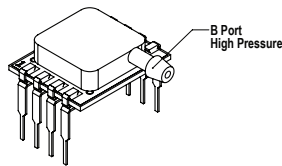

Pin	I2C	SPI
	Definition	Definition
1	Vs	Vs
2	Gnd	Gnd
3	Vout	Vout
4	Do not Connect	MISO
5	SCL	CLK
6	Do not Connect	SS
7	Do not Connect	Do not Connect
8	SDA	MOSI

**NOTES**

- 1) Dimensions are in inches [mm].
- 2) For suggested pad layout, see drawing: PAD-27.

### All Sensors

TITLE: F-Series Package

SIZE FILE NAME  
**A** FN5D Package



## Package Drawings (Cont'd)

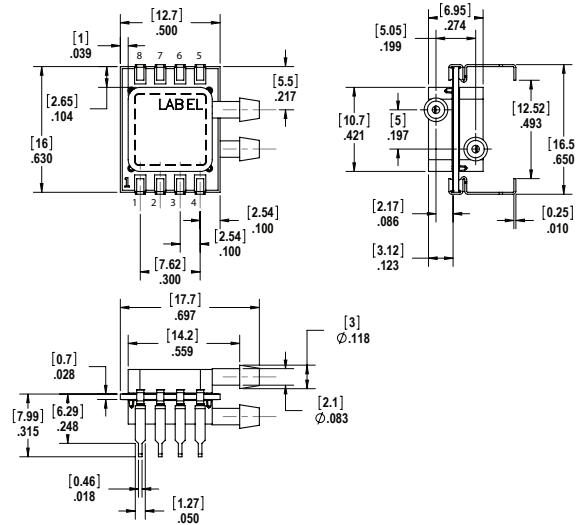
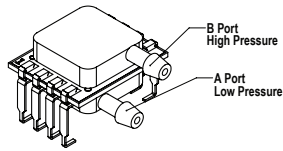

### NOTES

- 1) Dimensions are in inches [mm].
- 2) For suggested pad layout, see drawing: PAD-29.

Pin	I2C	SPI
	Definition	Definition
1	Vs	Vs
2	Gnd	Gnd
3	Vout	Vout
4	Do not Connect	MISO
5	SCL	CLK
6	Do not Connect	SS
7	Do not Connect	Do not Connect
8	SDA	MOSI

## All Sensors

TITLE: F-Series Package

SIZE FILE NAME  
**A** FISL Package

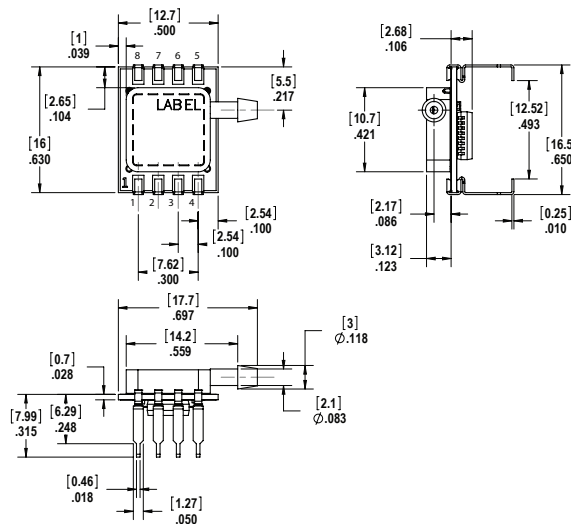
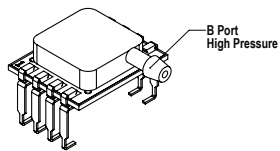

### NOTES

- 1) Dimensions are in inches [mm].
- 2) For suggested pad layout, see drawing: PAD-29.

Pin	I2C	SPI
	Definition	Definition
1	Vs	Vs
2	Gnd	Gnd
3	Vout	Vout
4	Do not Connect	MISO
5	SCL	CLK
6	Do not Connect	SS
7	Do not Connect	Do not Connect
8	SDA	MOSI

## All Sensors

TITLE: F-Series Package

SIZE FILE NAME  
**A** FNLS Package

## Package Drawings (Cont'd)

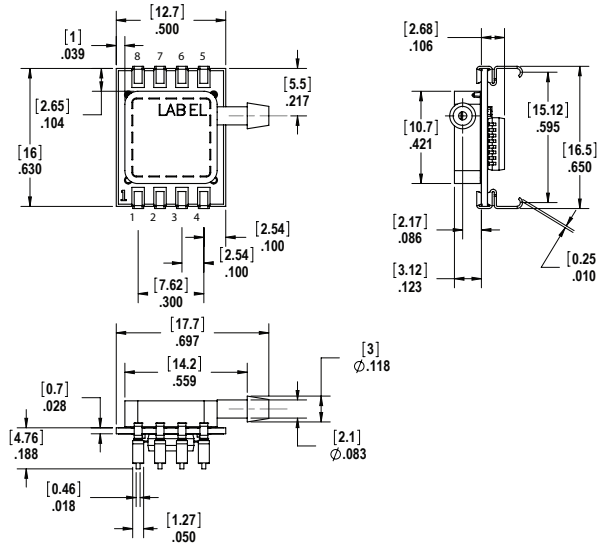
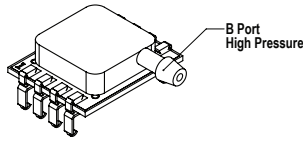

### NOTES

- 1) Dimensions are in inches [mm].
- 2) For suggested pad layout, see drawing: PAD-28.

Pin	I2C	SPI
	Definition	Definition
1	Vs	Vs
2	Gnd	Gnd
3	Vout	Vout
4	Do not Connect	MISO
5	SCL	CLK
6	Do not Connect	SS
7	Do not Connect	Do not Connect
8	SDA	MOSI

## All Sensors

TITLE: F-Series Package

SIZE FILE NAME  
**A** FNSJ Package



## Product Labeling

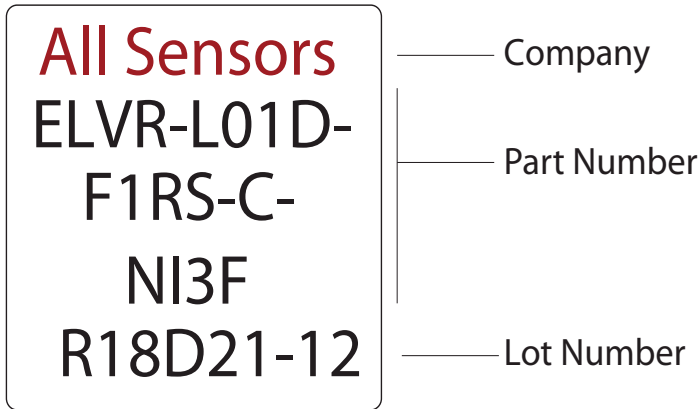

Example Device Label

## Suggested Pad Layouts

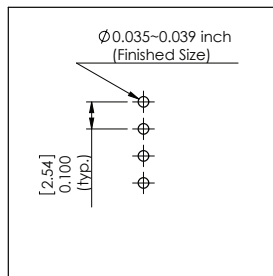

PAD-01

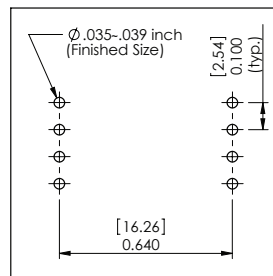

PAD-27

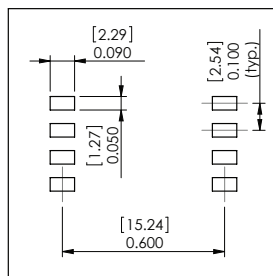

PAD-28

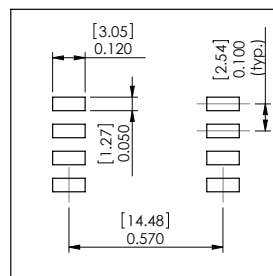

PAD-29

All Sensors reserves the right to make changes to any products herein. All Sensors does not assume any liability arising out of the application or use of any product or circuit described herein, neither does it convey any license under its patent rights nor the rights of others.



Компания «ЭлектроПласт» предлагает заключение долгосрочных отношений при поставках импортных электронных компонентов на взаимовыгодных условиях!

Наши преимущества:

- Оперативные поставки широкого спектра электронных компонентов отечественного и импортного производства напрямую от производителей и с крупнейших мировых складов;
- Поставка более 17-ти миллионов наименований электронных компонентов;
- Поставка сложных, дефицитных, либо снятых с производства позиций;
- Оперативные сроки поставки под заказ (от 5 рабочих дней);
- Экспресс доставка в любую точку России;
- Техническая поддержка проекта, помощь в подборе аналогов, поставка прототипов;
- Система менеджмента качества сертифицирована по Международному стандарту ISO 9001;
- Лицензия ФСБ на осуществление работ с использованием сведений, составляющих государственную тайну;
- Поставка специализированных компонентов (Xilinx, Altera, Analog Devices, Intersil, Interpoint, Microsemi, Aeroflex, Peregrine, Syfer, Eurofarad, Texas Instrument, Miteq, Cobham, E2V, MA-COM, Hittite, Mini-Circuits, General Dynamics и др.);

Помимо этого, одним из направлений компании «ЭлектроПласт» является направление «Источники питания». Мы предлагаем Вам помощь Конструкторского отдела:

- Подбор оптимального решения, техническое обоснование при выборе компонента;
- Подбор аналогов;
- Консультации по применению компонента;
- Поставка образцов и прототипов;
- Техническая поддержка проекта;
- Защита от снятия компонента с производства.



#### Как с нами связаться

**Телефон:** 8 (812) 309 58 32 (многоканальный)

**Факс:** 8 (812) 320-02-42

**Электронная почта:** [org@eplast1.ru](mailto:org@eplast1.ru)

**Адрес:** 198099, г. Санкт-Петербург, ул. Калинина, дом 2, корпус 4, литера А.