



Typical Applications

The HMC264LM3 is ideal for:

- 20 and 30 GHz Microwave Radios
- Up and Down Converter for Point-to-Point Radios
- LMDS and SATCOM

Features

- Integrated LO Amplifier: -4 dBm Input
- Sub-Harmonically Pumped (x2) LO
- High 2LO/RF Isolation: 35 dB
- LM3 SMT Package

Functional Diagram

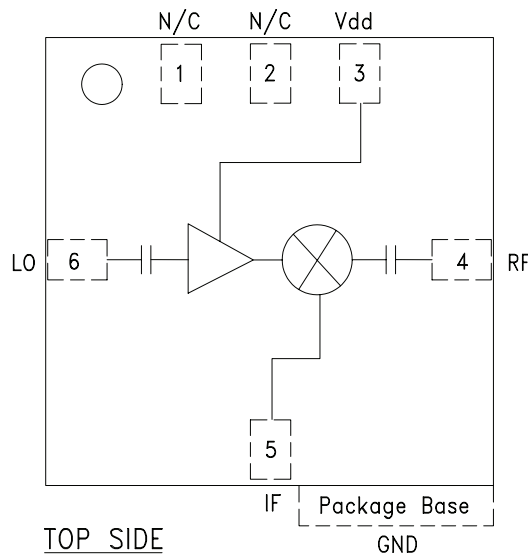

General Description

The HMC264LM3 is a 20 - 30 GHz surface mount sub-harmonically pumped (x2) MMIC mixer with an integrated LO amplifier in a SMT leadless chip carrier package. The 2LO to RF isolation is an excellent 25 to 35 dB, eliminating the need for additional filtering. The LO amplifier is a single bias (+3V to +4V) two stage design with only -4 dBm drive requirement. All data is with the non-hermetic, epoxy sealed LM3 packaged device mounted in a 50 ohm test fixture. Utilizing the HMC264LM3 eliminates the need for wirebonding, thereby providing a consistent connection interface for the customer.

Electrical Specifications, $T_A = +25^\circ C$, As a Function of LO Drive & Vdd

Parameter	IF = 1 GHz LO = -4 dBm & Vdd = +4V			IF = 1 GHz LO = -4 dBm & Vdd = +3V			Units
	Min.	Typ.	Max.	Min.	Typ.	Max.	
Frequency Range, RF	20 - 30			21 - 30			GHz
Frequency Range, LO	10 - 15			10.5 - 15			GHz
Frequency Range, IF	DC - 4			DC - 4			GHz
Conversion Loss		9	12		9	12	dB
Noise Figure (SSB)		9	12		9	12	dB
2LO to RF Isolation	20	35		16	30		dB
2LO to IF Isolation	30	40		26	38		dB
IP3 (Input)	5	12		4	10		dBm
1 dB Compression (Input)	-2	+4		-1	+2		dBm
Supply Current (I _{dd})		28			25		mA

*Unless otherwise noted, all measurements performed as downconverter, IF= 1 GHz.



**GaAs MMIC SUB-HARMONIC
SMT MIXER, 20 - 30 GHz**

**Conversion Gain vs.
Temperature @ LO = -4 dBm, Vdd = +4V**

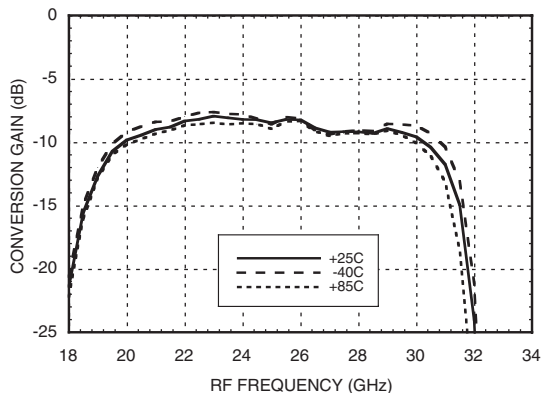

**Conversion Gain vs.
Temperature @ LO = -4 dBm, Vdd = +3V**

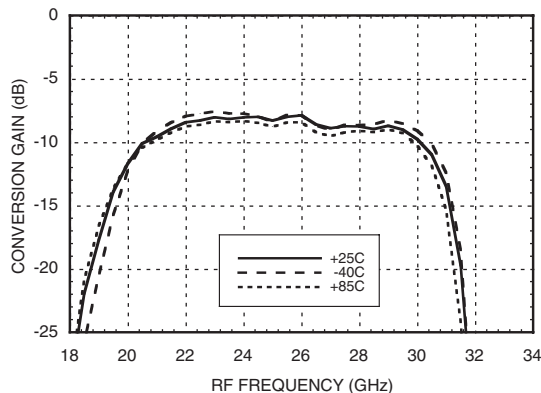

**Conversion Gain
vs. LO Drive @ Vdd = +4V**

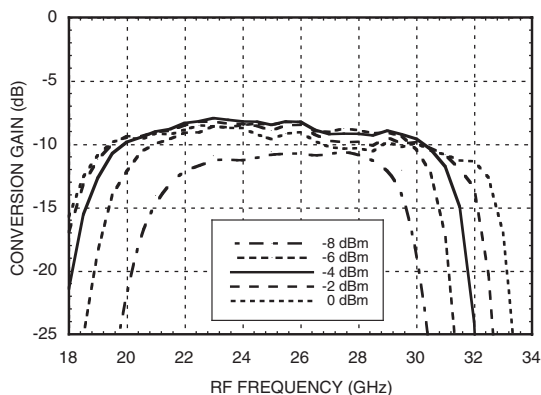

**Conversion Gain
vs. LO Drive @ Vdd = +3V**

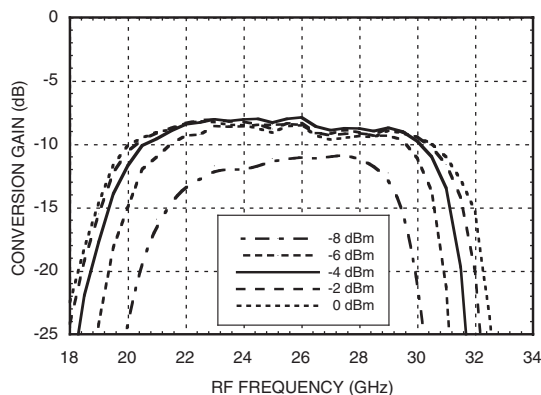

Isolation @ LO = -4 dBm, Vdd = +4V

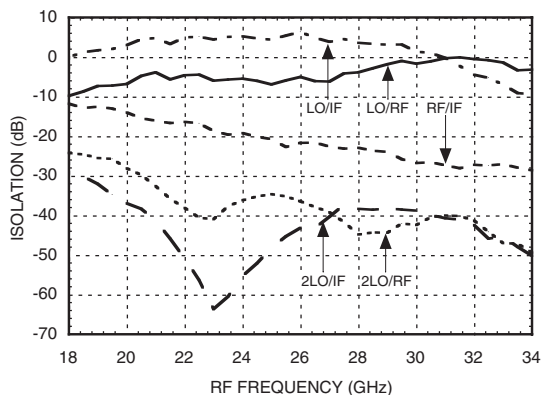

Isolation @ LO = -4 dBm, Vdd = +3V

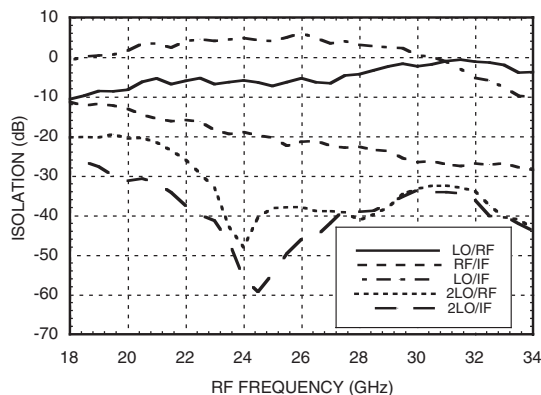

Input IP3 vs. LO Drive @ Vdd = +4V *

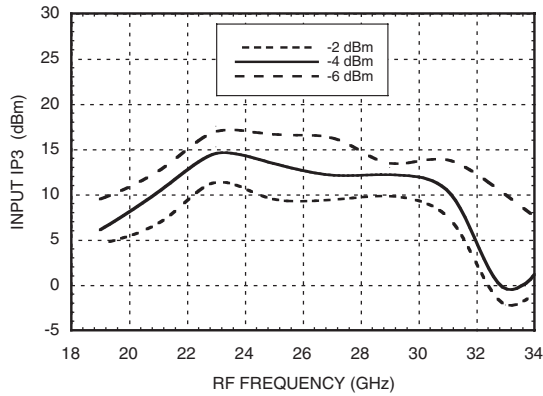

Input IP3 vs. LO Drive @ Vdd = +3V *

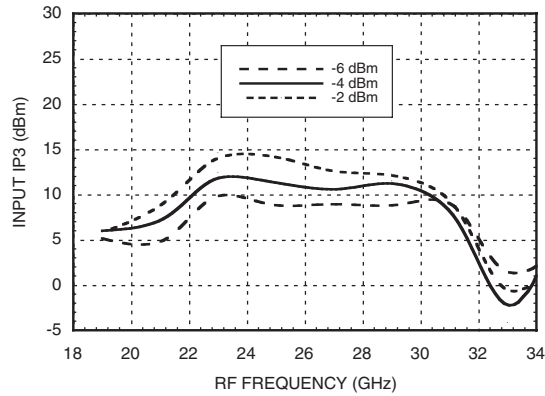

Input IP2 vs. LO Drive @ Vdd = +4V *

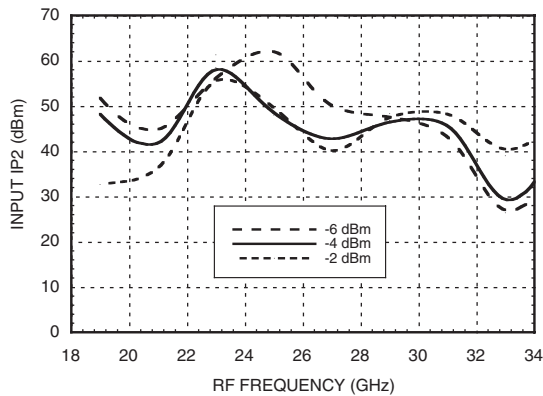

Input IP2 vs. LO Drive @ Vdd = +3V *

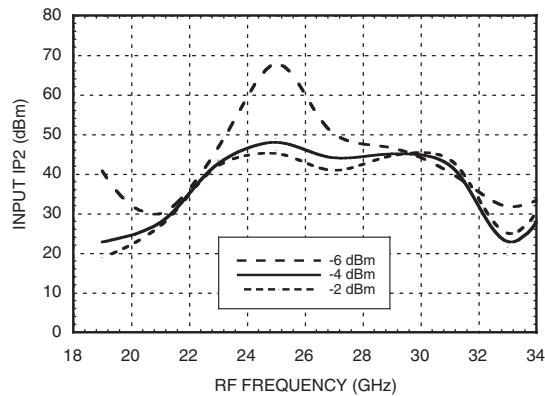

Input P1dB @ LO = -4 dBm, Vdd = +4V

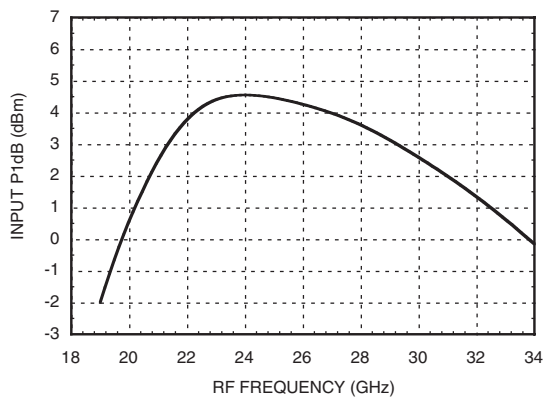

Input P1dB @ LO = -4 dBm, Vdd = +3V

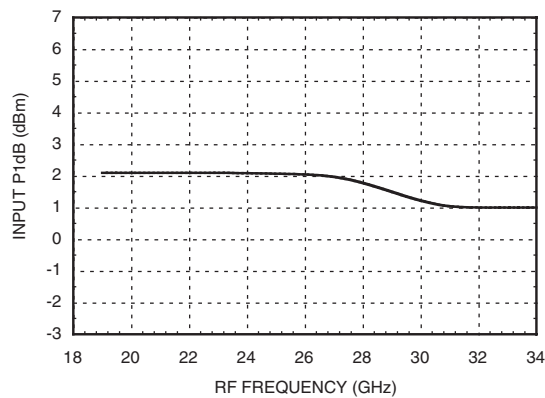

* Two-tone input power = -10 dBm each tone, 1 MHz spacing.



GaAs MMIC SUB-HARMONIC SMT MIXER, 20 - 30 GHz

Upconverter Performance

Conversion Gain, LO = -4 dBm Vdd = +4V

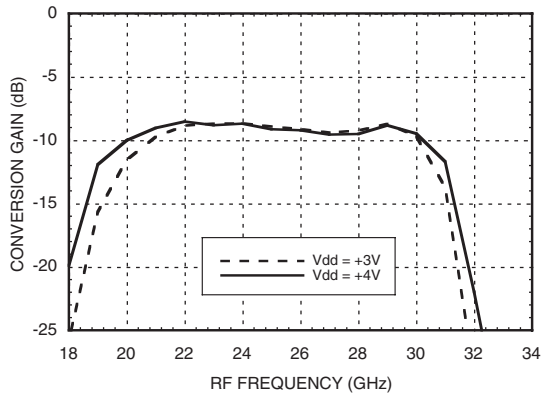

IF Bandwidth @ LO = -4 dBm

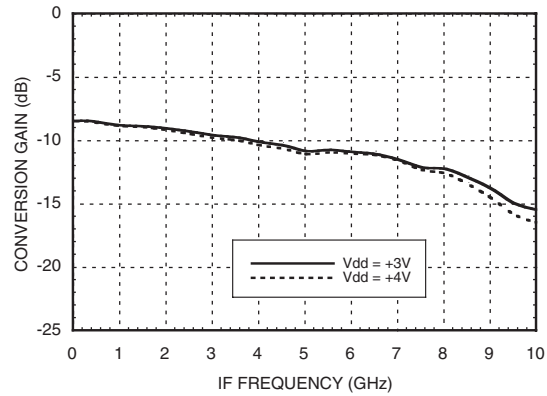

RF & LO Return Loss

@ LO = -4 dBm, Vdd = +4V

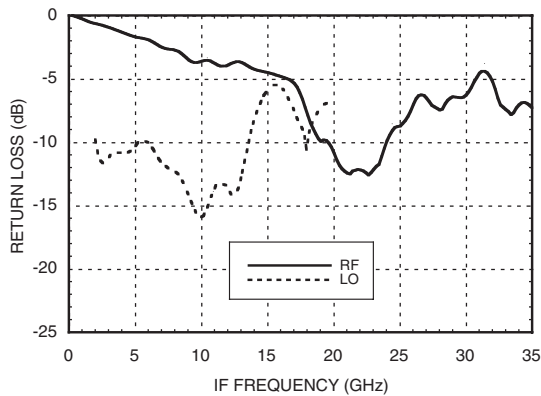

IF Return Loss

@ LO = -4 dBm, Vdd = +4V

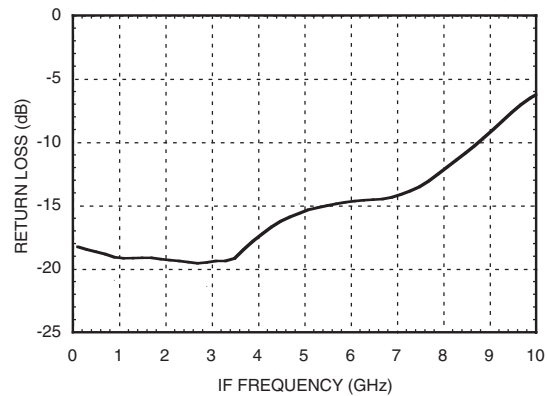

MxN Spurious Outputs

@ LO = -4 dBm, Vdd = +4V

mRF	nLO					
	±5	±4	±3	±2	±1	0
-3						
-2	34.8					
-1	61.8	26.1	32.6			
0				14.1	-26.9	
1				X	33.8	12.3
2		49.0	48.1			
3	78.8	81.3				

RF = 30 GHz @ -10 dBm
 LO = 13.5 GHz @ -4 dBm
 All values in dBc below IF power level.

Absolute Maximum Ratings

RF / IF Input (Vdd = +5V)	+13 dBm
LO Drive (Vdd = +5V)	+13 dBm
Vdd	5.5V
Continuous Pdiss (Ta = 85 °C) (derate 2.52 mW/°C above 85 °C)	227 mW
Storage Temperature	-65 to +150 °C
Operating Temperature	-40 to +85 °C



ELECTROSTATIC SENSITIVE DEVICE
OBSERVE HANDLING PRECAUTIONS

Outline Drawing

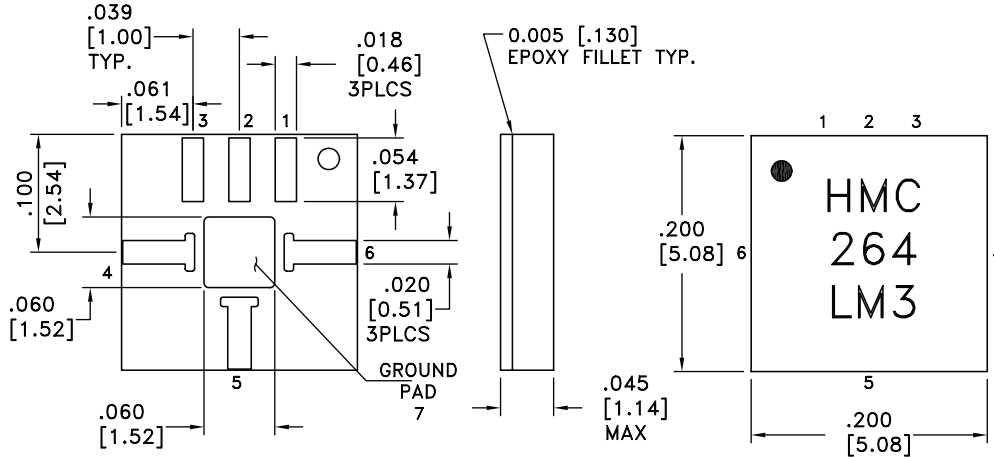

NOTES:

1. MATERIAL: PLASTIC
2. PLATING: GOLD OVER NICKEL
3. DIMENSIONS ARE IN INCHES [MILLIMETERS].
4. ALL TOLERANCES ARE ± 0.005 [± 0.13].
5. ALL GROUNDS MUST BE SOLDERED TO PCB RF GROUND.
6. ● INDICATES PIN 1

Pin Descriptions

Pin Number	Function	Description	Interface Schematic
1, 2	N/C	This pin may be connected to the housing ground or left unconnected.	
3	Vdd	Power supply for the LO Amplifier. An external RF bypass capacitor of 100 - 330 pF is required as close to the package as possible.	
4	RF	This pin is AC coupled and matched to 50 Ohm from 20 - 30 GHz.	RF
5	IF	This pin is DC coupled and should be DC blocked externally using a series capacitor whose value has been chosen to pass the necessary IF frequency range. Any applied DC voltage to this pin will result in die non-function and possible die failure.	IF
6	LO	This pin is AC coupled and matched to 50 Ohm from 10 - 15 GHz.	LO
7	GND	Must be soldered to PCB RF ground.	

Evaluation PCB

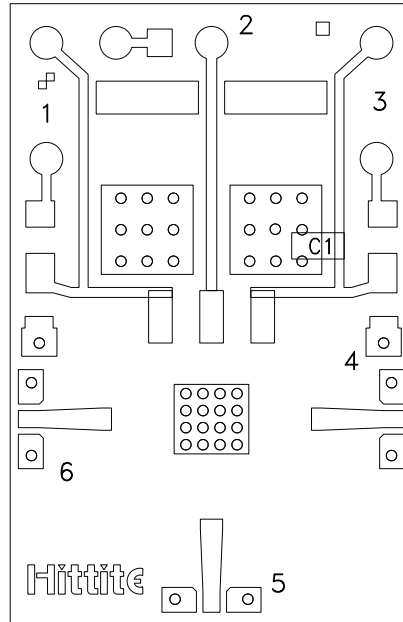

The grounded Co-Planar Wave Guide (CPWG) PCB input/output transitions allow use of Ground-Signal-Ground (GSG) probes for testing. Suggested probe pitch is 400mm (16 mils). Alternatively, the board can be mounted in a metal housing with 2.4 mm coaxial connectors.

Evaluation Circuit Board Layout Design Details

Layout Technique	Micro Strip to CPWG
Material	Rogers 4003 with 1/2 oz. Cu
Dielectric Thickness	0.008" (0.20 mm)
Microstrip Line Width	0.018" (0.46 mm)
CPWG Line Width	0.016" (0.41 mm)
CPWG Line to GND Gap	0.005" (0.13 mm)
Ground to Via Hole Diameter	0.008" (0.20 mm)
C1	100 pF Capacitor, 0402 Pkg.

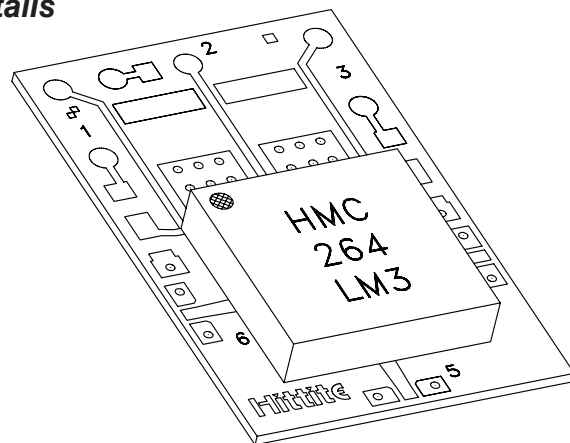

LM3 package mounted to evaluation PCB



Suggested LM3-01 PCB Land Pattern Tolerance: $\pm 0.003''$ (± 0.08 mm)

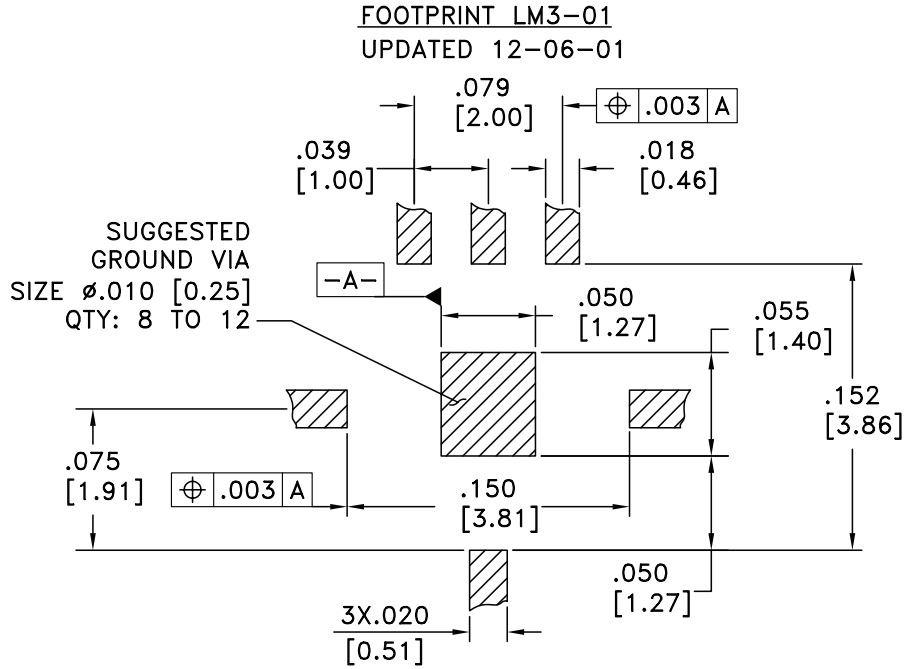



HMC264LM3 Recommended SMT Attachment Technique

Preparation & Handling of the LM3 Millimeterwave Package for Surface Mounting

The HMC LM3 package was designed to be compatible with high volume surface mount PCB assembly processes. The LM3 package requires a specific mounting pattern to allow proper mechanical attachment and to optimize electrical performance at millimeterwave frequencies. This PCB layout pattern can be found on each LM3 product data sheet. It can also be provided as an electronic drawing upon request from Hittite Sales & Application Engineering.

Follow these precautions to avoid permanent damage:

Cleanliness: Observe proper handling procedures to ensure clean devices and PCBs. LM3 devices should remain in their original packaging until component placement to ensure no contamination or damage to RF, DC & ground contact areas.

Static Sensitivity: Follow ESD precautions to protect against ESD strikes.

General Handling: Handle the LM3 package on the top with a vacuum collet or along the edges with a sharp pair of bent tweezers. Avoiding damaging the RF, DC, & ground contacts on the package bottom. Do not apply excess pressure to the top of the lid.

Solder Materials & Temperature Profile: Follow the information contained in the application note. Hand soldering is not recommended. Conductive epoxy attachment is not recommended.

Solder Paste

Solder paste should be selected based on the user's experience and be compatible with the metallization systems used. See the LM3 data sheet Outline drawing for pin & ground contact metallization schemes.

Solder Paste Application

Solder paste is generally applied to the PCB using either a stencil printer or dot placement. The volume of solder paste will be dependent on PCB and component layout and should be controlled to ensure consistent mechanical & electrical performance. Excess solder may create unwanted electrical parasitics at high frequencies.

Solder Reflow

The soldering process is usually accomplished in a reflow oven but may also use a vapor phase process. A solder reflow profile is suggested above.

Prior to reflowing product, temperature profiles should be measured using the same mass as the actual assemblies. The thermocouple should be moved to various positions on the board to account for edge and corner effects and varying component masses. The final profile should be determined by mounting the thermocouple to the PCB at the location of the device.

Follow solder paste and oven vendor's recommendations when developing a solder reflow profile. A standard profile will have a steady ramp up from room temperature to the pre-heat temperature to avoid damage due to thermal shock. Allow enough time between reaching pre-heat temperature and reflow for the solvent in the paste to evaporate and the flux to completely activate. Reflow must then occur prior to the flux being completely driven off. The duration of peak reflow temperature should not exceed 15 seconds. Packages have been qualified to withstand a peak temperature of 235°C for 15 seconds. Verify that the profile will not expose device to temperatures in excess of 235°C.

Cleaning

A water-based flux wash may be used.

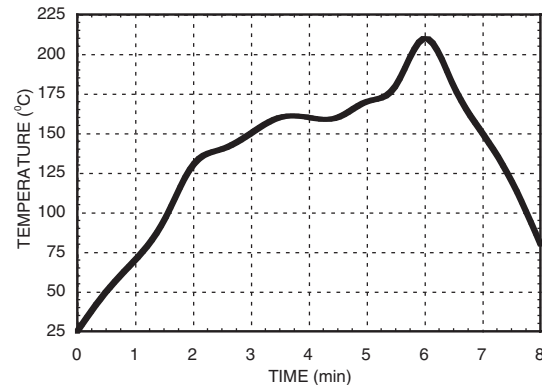



Компания «ЭлектроПласт» предлагает заключение долгосрочных отношений при поставках импортных электронных компонентов на взаимовыгодных условиях!

Наши преимущества:

- Оперативные поставки широкого спектра электронных компонентов отечественного и импортного производства напрямую от производителей и с крупнейших мировых складов;
- Поставка более 17-ти миллионов наименований электронных компонентов;
- Поставка сложных, дефицитных, либо снятых с производства позиций;
- Оперативные сроки поставки под заказ (от 5 рабочих дней);
- Экспресс доставка в любую точку России;
- Техническая поддержка проекта, помощь в подборе аналогов, поставка прототипов;
- Система менеджмента качества сертифицирована по Международному стандарту ISO 9001;
- Лицензия ФСБ на осуществление работ с использованием сведений, составляющих государственную тайну;
- Поставка специализированных компонентов (Xilinx, Altera, Analog Devices, Intersil, Interpoint, Microsemi, Aeroflex, Peregrine, Syfer, Eurofarad, Texas Instrument, Miteq, Cobham, E2V, MA-COM, Hittite, Mini-Circuits, General Dynamics и др.);

Помимо этого, одним из направлений компании «ЭлектроПласт» является направление «Источники питания». Мы предлагаем Вам помощь Конструкторского отдела:

- Подбор оптимального решения, техническое обоснование при выборе компонента;
- Подбор аналогов;
- Консультации по применению компонента;
- Поставка образцов и прототипов;
- Техническая поддержка проекта;
- Защита от снятия компонента с производства.



Как с нами связаться

Телефон: 8 (812) 309 58 32 (многоканальный)

Факс: 8 (812) 320-02-42

Электронная почта: org@eplast1.ru

Адрес: 198099, г. Санкт-Петербург, ул. Калинина, дом 2, корпус 4, литера А.