

General Description

The MAX14736/MAX14737 evaluation kit (EV kit) is a fully assembled and tested circuit board that demonstrates the precision, ultra-fast, low quiescent current overvoltage-protection devices. The EV kit features an LED power OK (POK) reading. The EV kit comes with the MAX14736EWL+ or MAX14737EWL+ installed. Please indicate the part number when ordering.

Features

- 2.1V to 5.5V Operating Voltage Range
- Power Ok (POK) LED Reading
- Proven PCB Layout
- Fully Assembled and Tested

EV Kit Contents

- EV Kit board containing a MAX14736/MAX14737

Ordering Information appears at end of data sheet.

Table 1. Enable Input Jumper Settings (JU1)

JUMPER	SHUNT POSITION	DESCRIPTION
JU1	Installed	\overline{EN}/EN is pulled down to ground. (MAX14736: enable, MAX14737: disable)
	Not installed	\overline{EN}/EN is pulled up to IN. (MAX14736: disable, MAX14737: enable)

Quick Start

Required Equipment

- MAX14736/MAX14737 EV kit
- 10V DC power supply
- Multimeter

Procedure

The EV kit is fully assembled and tested. Follow the steps below to verify board operation:

- 1) Verify that jumper JU1 is installed for the MAX14736 and not installed for the MAX14737.
- 2) Apply 2.1V to IN. Verify that OUT is at 2.1V and that the LED1 is on.
- 3) Slowly increase IN and verify that the OUT voltage is the same as IN. When IN reaches ~4.7V (for MAX14736) or ~5.2V (for MAX14737), the switch turns off, the OUT voltage goes down, and the LED1 is off. Do not apply a voltage higher than 5.5V to IN.
- 4) Slowly decrease IN. When IN reaches ~4.6V (for MAX14736) or ~5.1V (for MAX14737), switch turns on, OUT voltage is same as IN, and LED1 is on.

Detailed Description

The MAX14736/MAX14737 EV kit is a fully assembled and tested circuit board demonstrating these overvoltage-protection devices in a 9-bump wafer-level package (WLP).

The MAX14736 has a 4.7V (typ) precision overvoltage threshold, while the overvoltage threshold for the MAX14737 is 5.2V (typ). The MAX14736 has an active-low enable pin (\overline{EN}), while the enable pin (EN) on the MAX14737 is active-high.

LED Indicator

The EV kit features LED1 to indicate POK output.

Enable Input

Use JU1 to enable/disable the device (see [Table 1](#) for jumper settings).



Ordering Information

PART	TYPE	OVLO (V)
MAX14736EVKIT#	EVKIT	4.7
MAX14737EVKIT#	EVKIT	5.2

#Denotes RoHS compliant.

Component List, PCB Layout, and Schematic

See the following links for the component information, PCB layout and schematic:

- [MAX14736 EV BOM](#)
- [MAX14736 EV PCB Layout](#)
- [MAX14736 EV Schematic](#)

Revision History

REVISION NUMBER	REVISION DATE	DESCRIPTION	PAGES CHANGED
0	7/15	Initial release	—
1	8/15	Updated <i>Schematic</i> and <i>Bill-of-Materials</i>	N/A

For pricing, delivery, and ordering information, please contact Maxim Direct at 1-888-629-4642, or visit Maxim Integrated's website at www.maximintegrated.com.

Maxim Integrated cannot assume responsibility for use of any circuitry other than circuitry entirely embodied in a Maxim Integrated product. No circuit patent licenses are implied. Maxim Integrated reserves the right to change the circuitry and specifications without notice at any time.

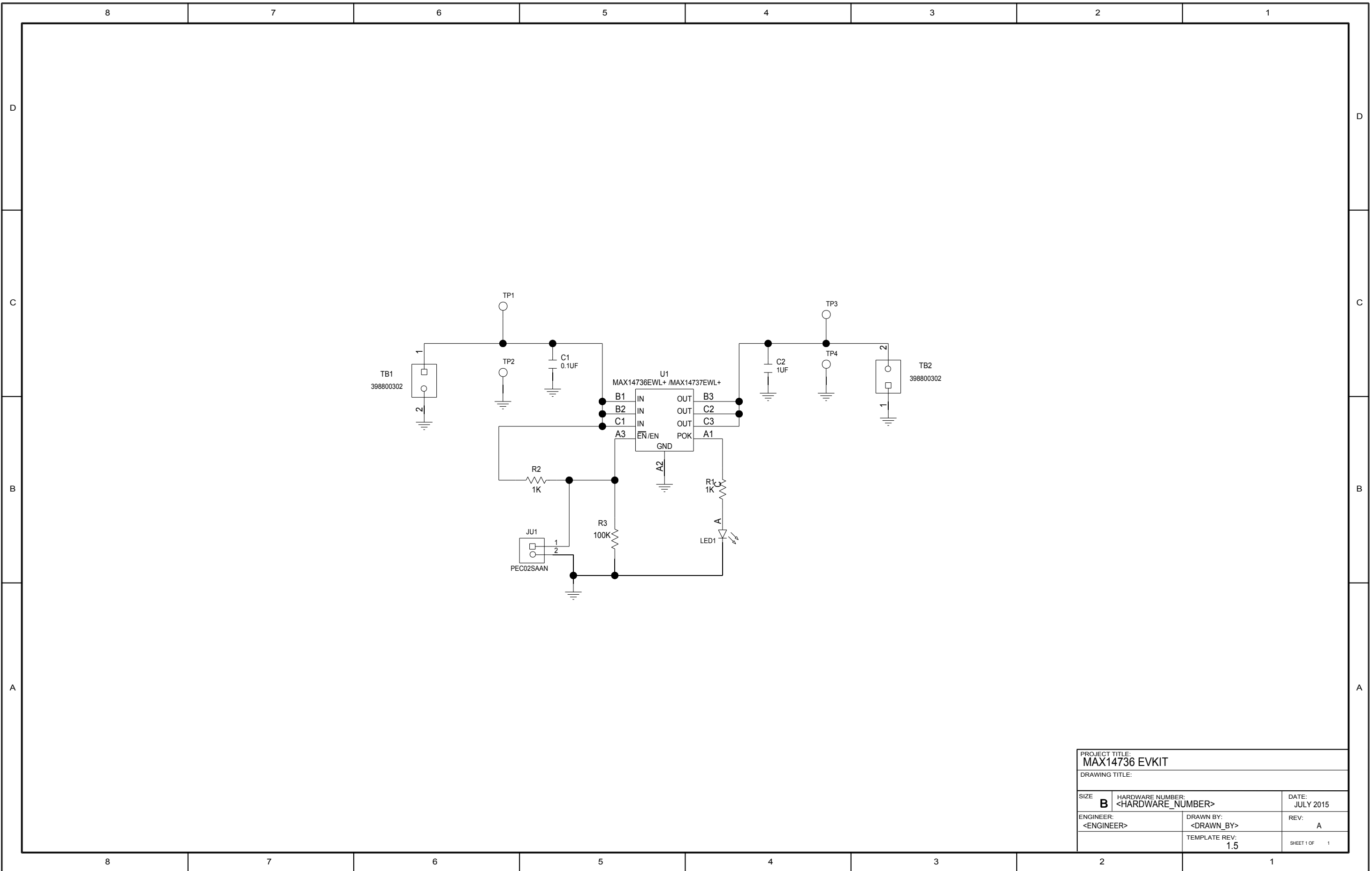

PROJECT TITLE: MAX14736 EVKIT		
DRAWING TITLE:		
SIZE B	HARDWARE NUMBER: <HARDWARE_NUMBER>	DATE: JULY 2015
ENGINEER: <ENGINEER>	DRAWN BY: <DRAWN_BY>	REV: A
	TEMPLATE REV: 1.5	SHEET 1 OF 1



This document contains information considered proprietary, and shall not be reproduced wholly or in part, nor disclosed to others without specific written permission.

HARDWARE NAME: MAX14736_EVKIT_A

HARDWARE NUMBER:

ENGINEER: DESIGNER:

DATE: 07/16/2015 ODB++/GERBER: SILK_TOP

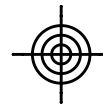
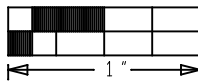
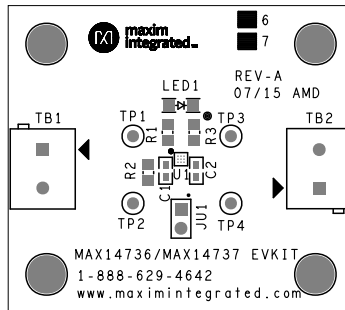
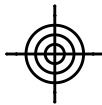



This document contains information considered proprietary, and shall not be reproduced wholly or in part, nor disclosed to others without specific written permission.

HARDWARE NAME: MAX14736_EVKIT_A

HARDWARE NUMBER:

ENGINEER:

DESIGNER:

DATE: 07/16/2015

ODB++/GERBER: TOP

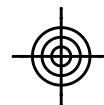
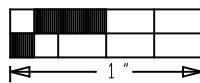
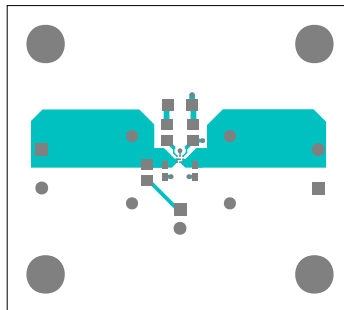
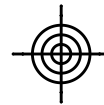
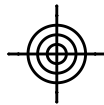



This document contains information considered proprietary, and shall not be reproduced wholly or in part, nor disclosed to others without specific written permission.

HARDWARE NAME: MAX14736_EVKIT_A

HARDWARE NUMBER:

ENGINEER: DESIGNER:

DATE: 07/16/2015

ODB++/GERBER: BOTTOM

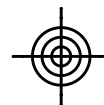
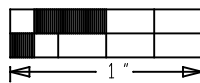
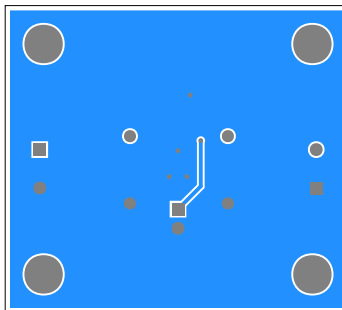
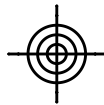

BILL OF MATERIALS (BOM) Revision 8/15

Part Reference	Qty	Description
C1	1	CAPACITOR CER 0.1UF 10V ±10% X7R 0603
C2	1	CAPACITOR CER 1UF 10V ±10% X7R 0603
JU1	1	2 PIN STRAIGHT MALE HEADER
LED1	1	RED LED, LITE-ON LTST-C150CKT
R1,R2	2	RES 1K OHM 1% 0805 SMD
R3	1	RES 100K OHM 1% 0805 SMD
TB1, TB2	2	TERMINAL BLOCK
TP1, TP3	2	RED TEST POINT
TP2, TP4	2	BLACK TEST POINT
U1	1	IC LOW CURRENT OVERVOLTAGE PROTECTION (MAX14736EWL+/MAX14737EWL+)
	1	PCB: EPCB14736/14737



Компания «ЭлектроПласт» предлагает заключение долгосрочных отношений при поставках импортных электронных компонентов на взаимовыгодных условиях!

Наши преимущества:

- Оперативные поставки широкого спектра электронных компонентов отечественного и импортного производства напрямую от производителей и с крупнейших мировых складов;
- Поставка более 17-ти миллионов наименований электронных компонентов;
- Поставка сложных, дефицитных, либо снятых с производства позиций;
- Оперативные сроки поставки под заказ (от 5 рабочих дней);
- Экспресс доставка в любую точку России;
- Техническая поддержка проекта, помощь в подборе аналогов, поставка прототипов;
- Система менеджмента качества сертифицирована по Международному стандарту ISO 9001;
- Лицензия ФСБ на осуществление работ с использованием сведений, составляющих государственную тайну;
- Поставка специализированных компонентов (Xilinx, Altera, Analog Devices, Intersil, Interpoint, Microsemi, Aeroflex, Peregrine, Syfer, Eurofarad, Texas Instrument, Miteq, Cobham, E2V, MA-COM, Hittite, Mini-Circuits, General Dynamics и др.);

Помимо этого, одним из направлений компании «ЭлектроПласт» является направление «Источники питания». Мы предлагаем Вам помощь Конструкторского отдела:

- Подбор оптимального решения, техническое обоснование при выборе компонента;
- Подбор аналогов;
- Консультации по применению компонента;
- Поставка образцов и прототипов;
- Техническая поддержка проекта;
- Защита от снятия компонента с производства.



Как с нами связаться

Телефон: 8 (812) 309 58 32 (многоканальный)

Факс: 8 (812) 320-02-42

Электронная почта: org@eplast1.ru

Адрес: 198099, г. Санкт-Петербург, ул. Калинина, дом 2, корпус 4, литера А.