



TISP4070J3BJ THRU TISP4395J3BJ

BIDIRECTIONAL THYRISTOR OVERVOLTAGE PROTECTORS

TISP4xxxJ3BJ Overvoltage Protector Series

Ion-Implanted Breakdown Region
- Precise and Stable Voltage

Low Voltage Overshoot Under Surge

Designed for Transformer Center Tap (Ground Return)
Overvoltage Protection

- Enables GR-1089-CORE Compliance
- High Holding Current Allows Protection of Data Lines with d.c Power Feed

Can be Used to Protect Rugged Modems Designed for Exposed Applications Exceeding TIA-968-A

| Device Name | V _{DRM} V | V _(BO) V |
|--------------|-----------------------|------------------------|
| TISP4070J3BJ | 58 | 70 |
| TISP4080J3BJ | 65 | 80 |
| TISP4095J3BJ | 75 | 95 |
| TISP4115J3BJ | 90 | 115 |
| TISP4125J3BJ | 100 | 125 |
| TISP4145J3BJ | 120 | 145 |
| TISP4165J3BJ | 135 | 165 |
| TISP4180J3BJ | 145 | 180 |
| TISP4200J3BJ | 155 | 200 |
| TISP4219J3BJ | 180 | 219 |
| TISP4250J3BJ | 190 | 250 |
| TISP4290J3BJ | 220 | 290 |
| TISP4350J3BJ | 275 | 350 |
| TISP4395H3BJ | 320 | 395 |

SMB Package (Top View)

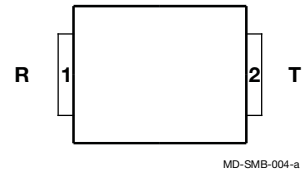

Device Symbol



Rated for International Surge Wave Shapes

| Wave Shape | Standard | I _{PPSM} A |
|------------|------------------|------------------------|
| 2/10 | GR-1089-CORE | 1000 |
| 8/20 | IEC 61000-4-5 | 800 |
| 10/160 | TIA-968-A | 400 |
| 10/700 | ITU-T K.20/21/45 | 350 |
| 10/560 | TIA-968-A | 250 |
| 10/1000 | GR-1089-CORE | 200 |

.....UL Recognized Component

Description

The range of TISP4xxxJ3BJ devices is designed to limit overvoltages on telecom lines. The TISP4xxxJ3BJ is primarily designed to address GR-1089-CORE compliance on data transmission lines with d.c. power feeding. When overvoltage protection is applied to transformer coupled lines from the transformer center tap to ground, the total ground return current can be 200 A, 10/1000 and 1000 A, 2/10. The high 150 mA holding current is set above common d.c. feed system levels to allow the TISP4xxxJ3BJ to reset following a disturbance.

These devices allow signal voltages, without clipping, up to the maximum off-state voltage value, V_{DRM}, see Figure 1. Voltages above V_{DRM} are limited and will not exceed the breakover voltage, V_(BO), level. If sufficient current flows due to the overvoltage, the device switches into a low voltage on-state condition, which diverts the current from the overvoltage through the device. When the diverted current falls below the holding current, I_H, level the devices switches off and restores normal system operation.

How to Order

| Device | Package | Carrier | Order As | Marking Code | Standard Quantity |
|--------------|---------|----------------------|-----------------|--------------|-------------------|
| TISP4xxxJ3BJ | SMB | Embossed Tape Reeled | TISP4xxxJ3BJR-S | 4xxxJ3 | 3000 |

Insert xxx corresponding to device name.

*RoHS Directive 2002/95/EC Jan 27 2003 including Annex
JULY 2003 – REVISED MAY 2007
Specifications are subject to change without notice.
Customers should verify actual device performance in their specific applications.

TISP4xxxJ3BJ Overvoltage Protector Series

BOURNS®

Absolute Maximum Ratings, $T_A = 25\text{ }^\circ\text{C}$ (Unless Otherwise Noted)

| Rating | Symbol | Value | Unit |
|---|------------|---|------------------|
| Repetitive peak off-state voltage | '4070J3BJ | ±58 | V |
| | '4080J3BJ | ±65 | |
| | '4095J3BJ | ±75 | |
| | '4115J3BJ | ±90 | |
| | '4125J3BJ | ±100 | |
| | '4145J3BJ | ±120 | |
| | '4165J3BJ | ±135 | |
| | '4180J3BJ | ±145 | |
| | '4200J3BJ | ±155 | |
| | '4219J3BJ | ±180 | |
| | '4250J3BJ | ±190 | |
| | '4290J3BJ | ±220 | |
| | '4350J3BJ | ±275 | |
| | '4395J3BJ | ±320 | |
| Non-repetitive peak impulse current (see Notes 1 and 2) 2/10 μs (GR-1089-CORE, 2/10 μs voltage wave shape) 8/20 μs (IEC 61000-4-5, combination wave generator, 1.2/50 μs voltage wave shape) 10/160 μs (TIA-968-A, 10/160 μs voltage wave shape) 4/250 μs (ITU-T K.20/21, 10/700 μs voltage waveshape, simultaneous) 5/310 μs (ITU-T K.20/21, 10/700 μs voltage wave shape, single) 5/320 μs (TIA-968-A, 9/720 μs voltage waveshape, single) 10/560 μs (TIA-968-A, 10/560 μs voltage wave shape) 10/1000 μs (GR-1089-CORE, 10/1000 μs voltage wave shape) | I_{PPSM} | ±1000 ±800 ±400 ±370 ±350 ±350 ±250 ±200 | A |
| Non-repetitive peak on-state current (see Notes 1 and 2) 20 ms, 50 Hz (full sine wave) | I_{TSM} | 50 | A |
| Initial rate of rise of on-state current. Linear current ramp. Maximum ramp value < 50 A | di_T/dt | 800 | A/ μs |
| Junction temperature | T_J | -40 to +150 | $^\circ\text{C}$ |
| Storage temperature range | T_{stg} | -65 to +150 | $^\circ\text{C}$ |

NOTES: 1. Initially the device must be in thermal equilibrium with $T_J = 25\text{ }^\circ\text{C}$.

2. These non-repetitive rated currents are peak values of either polarity. The surge may be repeated after the device returns to its initial conditions.

Electrical Characteristics, $T_A = 25\text{ }^\circ\text{C}$ (Unless Otherwise Noted)

| Parameter | Test Conditions | Min | Typ | Max | Unit |
|---|---|-----|-----|---|---------------|
| I_{DRM} Repetitive peak off-state current | $V_D = V_{DRM}$ $T_A = 25\text{ }^\circ\text{C}$ $T_A = 85\text{ }^\circ\text{C}$ | | | ±5 ±10 | μA |
| $V_{(BO)}$ AC Breakover voltage | $dv/dt = \pm 250\text{ V/ms}$, $R_{SOURCE} = 300\ \Omega$ | | | ±70 ±80 ±95 ±115 ±125 ±145 ±165 ±180 ±200 ±219 ±250 ±290 ±350 ±395 | V |

JULY 2003 – REVISED MAY 2007

Specifications are subject to change without notice.
Customers should verify actual device performance in their specific applications.

TISP4xxxJ3BJ Overvoltage Protector Series

BOURNS®

Electrical Characteristics, $T_A = 25\text{ }^\circ\text{C}$ (Unless Otherwise Noted) (Continued)

| Parameter | Test Conditions | Min | Typ | Max | Unit |
|---|--|--|-----------|-------------------------------------|-------------------|
| $V_{(BO)}$ Ramp breakover voltage | dv/dt \leq $\pm 1000\text{ V}/\mu\text{s}$, Linear voltage ramp, Maximum ramp value = $\pm 500\text{ V}$ di/dt = $\pm 20\text{ A}/\mu\text{s}$, Linear current ramp, Maximum ramp value = $\pm 10\text{ A}$ | '4070J3BJ | | ± 77 | V |
| | | '4080J3BJ | | ± 88 | |
| | | '4095J3BJ | | ± 104 | |
| | | '4115J3BJ | | ± 125 | |
| | | '4125J3BJ | | ± 135 | |
| | | '4145J3BJ | | ± 156 | |
| | | '4165J3BJ | | ± 177 | |
| | | '4180J3BJ | | ± 192 | |
| | | '4200J3BJ | | ± 212 | |
| | | '4219J3BJ | | ± 231 | |
| | | '4250J3BJ | | ± 263 | |
| | | '4290J3BJ | | ± 303 | |
| '4350J3BJ | | ± 364 | | | |
| '4395J3BJ | | ± 409 | | | |
| $I_{(BO)}$ Breakover current | dv/dt = $\pm 250\text{ V}/\text{ms}$, $R_{\text{SOURCE}} = 300\ \Omega$ | '4070J3BJ thru '4115J3BJ '4125J3BJ thru '4219J3BJ '4250J3BJ thru '4395J3BJ | | ± 900 ± 800 ± 600 | mA |
| I_H Holding current | $I_T = \pm 5\text{ A}$, di/dt = $\pm 30\text{ mA}/\text{ms}$ | | ± 150 | ± 600 | mA |
| dv/dt Critical rate of rise of off-state voltage | Linear voltage ramp Maximum ramp value $< 0.85V_{\text{DRM}}$ | ± 5 | | | kV/ μs |
| I_D Off-state current | $V_D = \pm 50\text{ V}$ $T_A = 85\text{ }^\circ\text{C}$ | | | ± 10 | μA |
| C_O Off-state capacitance | f = 1 MHz, $V_d = 1\text{ V rms}$, $V_D = 0$ | '4070J3BJ thru '4115J3BJ | 195 | 235 | pF |
| | | '4125J3BJ thru '4219J3BJ | 120 | 145 | |
| | | '4250J3BJ thru '4395J3BJ | 105 | 125 | |
| | f = 1 MHz, $V_d = 1\text{ V rms}$, $V_D = -1\text{ V}$ | '4070J3BJ thru '4115J3BJ | 180 | 215 | |
| | | '4125J3BJ thru '4219J3BJ | 110 | 132 | |
| | | '4250J3BJ thru '4395J3BJ | 95 | 115 | |
| | f = 1 MHz, $V_d = 1\text{ V rms}$, $V_D = -2\text{ V}$ | '4070J3BJ thru '4115J3BJ | 165 | 200 | |
| | | '4125J3BJ thru '4219J3BJ | 100 | 120 | |
| | | '4250J3BJ thru '4395J3BJ | 90 | 105 | |
| | f = 1 MHz, $V_d = 1\text{ V rms}$, $V_D = -50\text{ V}$ | '4070J3BJ thru '4115J3BJ | 85 | 100 | |
| | | '4125J3BJ thru '4219J3BJ | 50 | 60 | |
| | | '4250J3BJ thru '4395J3BJ | 42 | 50 | |
| f = 1 MHz, $V_d = 1\text{ V rms}$, $V_D = -100\text{ V}$ (see Note 3) | '4125J3BJ thru '4219J3BJ | 40 | 50 | | |
| | '4250J3BJ thru '4395J3BJ | 35 | 40 | | |

NOTE: 3. To avoid possible clipping, the TISP4125J3BJ is tested with $V_D = -98\text{ V}$.

Thermal Characteristics

| Parameter | Test Conditions | Min | Typ | Max | Unit |
|--|--|-----|-----|-----|---------------------------|
| $R_{\theta JA}$ Junction to ambient thermal resistance | EIA/JESD51-3 PCB, $I_T = I_{\text{TSM}(1000)}$ (see Note 4) | | | 90 | $^\circ\text{C}/\text{W}$ |

NOTE: 4. EIA/JESD51-2 environment and PCB has standard footprint dimensions connected with 5 A rated printed wiring track widths.

Parameter Measurement Information



PM-TISP4xxx-001-a

Figure 1. Voltage-Current Characteristic for T and R Terminals
All Measurements are Referenced to the R Terminal

Typical Characteristics

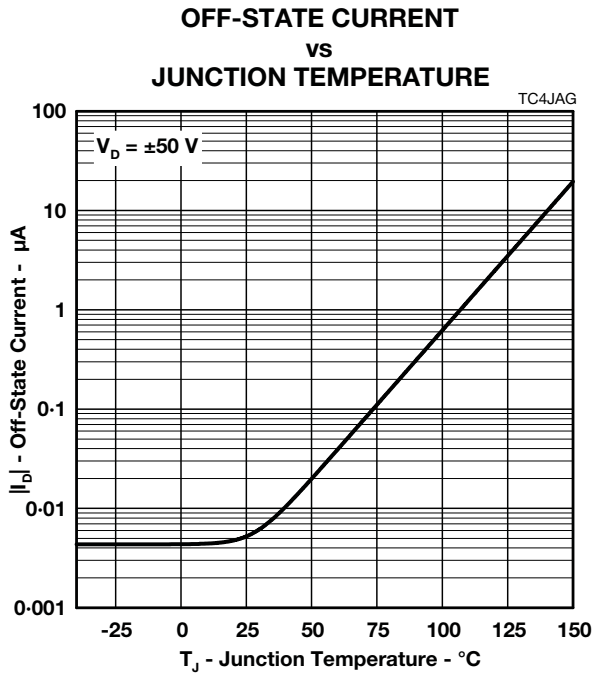

Figure 2.

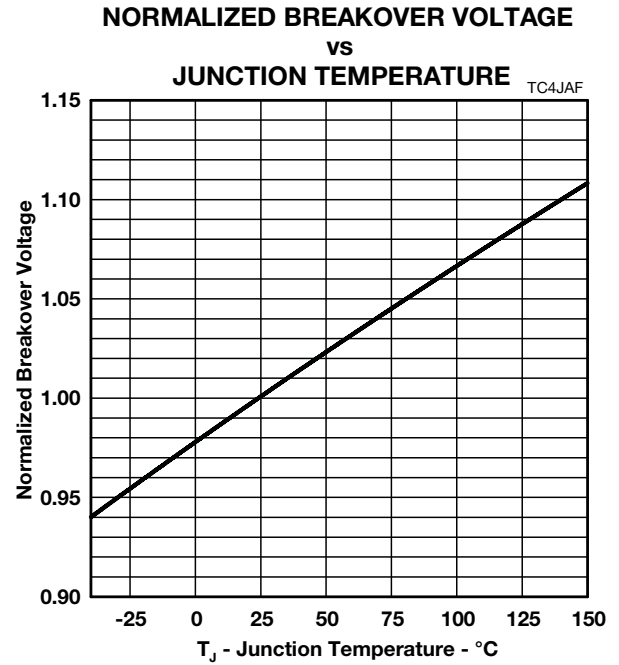

Figure 3.

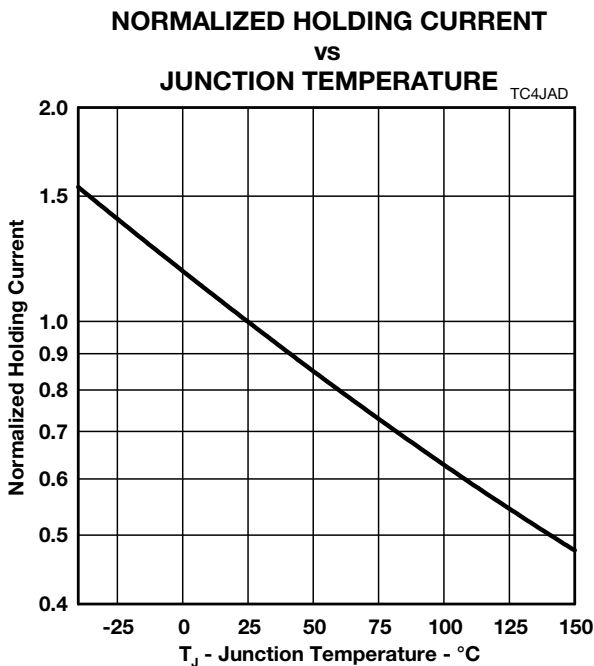

Figure 4.

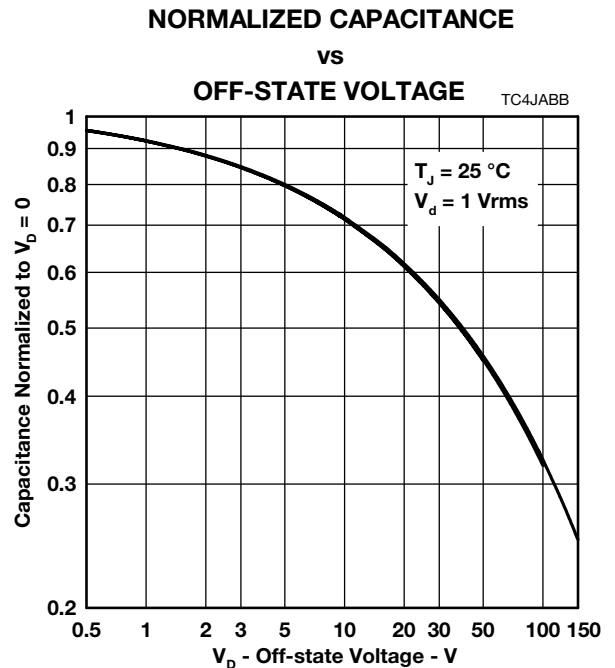

Figure 5.

Rating and Thermal Information

NON-REPETITIVE PEAK ON-STATE CURRENT vs CURRENT DURATION



Figure 6.

V_{DRM} DERATING FACTOR vs MINIMUM AMBIENT TEMPERATURE

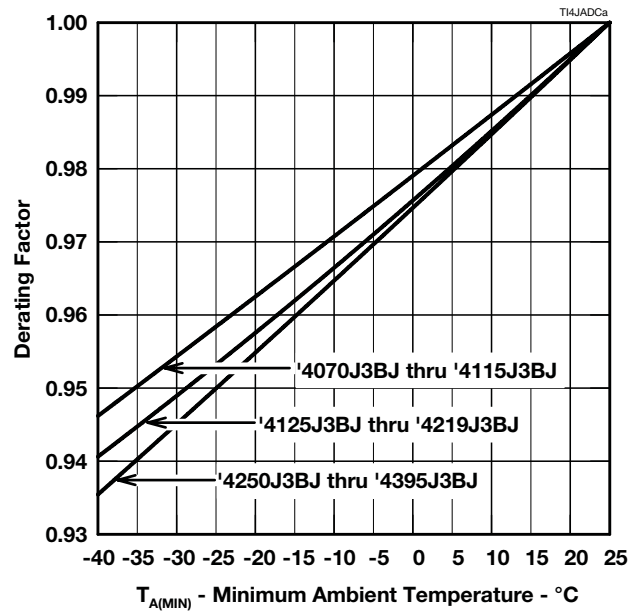

Figure 7.

TISP4xxxJ3BJ Overvoltage Protector Series

BOURNS®

Applications Information



Figure 8. Typical Application Circuit

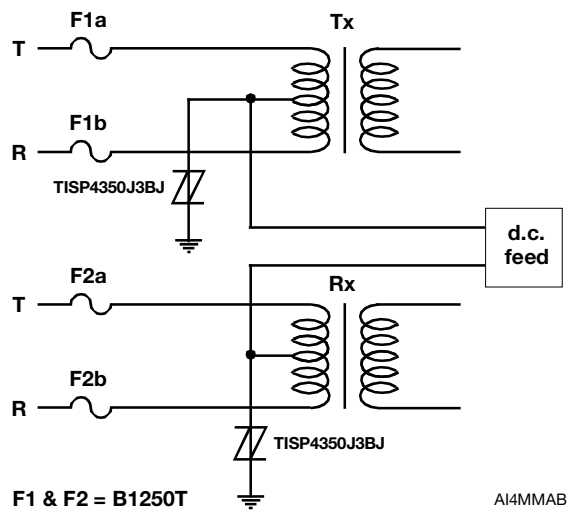

Figure 9. Typical Application Circuit

Bourns Sales Offices

| <u>Region</u> | <u>Phone</u> | <u>Fax</u> |
|---------------|-----------------|-----------------|
| The Americas: | +1-951-781-5500 | +1-951-781-5700 |
| Europe: | +41-41-7685555 | +41-41-7685510 |
| Asia-Pacific: | +886-2-25624117 | +886-2-25624116 |

Technical Assistance

| <u>Region</u> | <u>Phone</u> | <u>Fax</u> |
|---------------|-----------------|-----------------|
| The Americas: | +1-951-781-5500 | +1-951-781-5700 |
| Europe: | +41-41-7685555 | +41-41-7685510 |
| Asia-Pacific: | +886-2-25624117 | +886-2-25624116 |

www.bourns.com

Bourns® products are available through an extensive network of manufacturer's representatives, agents and distributors. To obtain technical applications assistance, a quotation, or to place an order, contact a Bourns representative in your area.



Reliable Electronic Solutions

"TISP" is a trademark of Bourns, Ltd., a Bourns Company, and is Registered in U.S. Patent and Trademark Office.
"Bourns" is a registered trademark of Bourns, Inc. in the U.S. and other countries.

JULY 2003 – REVISED MAY 2007
Specifications are subject to change without notice.
Customers should verify actual device performance in their specific applications.



Компания «ЭлектроПласт» предлагает заключение долгосрочных отношений при поставках импортных электронных компонентов на взаимовыгодных условиях!

Наши преимущества:

- Оперативные поставки широкого спектра электронных компонентов отечественного и импортного производства напрямую от производителей и с крупнейших мировых складов;
- Поставка более 17-ти миллионов наименований электронных компонентов;
- Поставка сложных, дефицитных, либо снятых с производства позиций;
- Оперативные сроки поставки под заказ (от 5 рабочих дней);
- Экспресс доставка в любую точку России;
- Техническая поддержка проекта, помощь в подборе аналогов, поставка прототипов;
- Система менеджмента качества сертифицирована по Международному стандарту ISO 9001;
- Лицензия ФСБ на осуществление работ с использованием сведений, составляющих государственную тайну;
- Поставка специализированных компонентов (Xilinx, Altera, Analog Devices, Intersil, Interpoint, Microsemi, Aeroflex, Peregrine, Syfer, Eurofarad, Texas Instrument, Miteq, Cobham, E2V, MA-COM, Hittite, Mini-Circuits, General Dynamics и др.);

Помимо этого, одним из направлений компании «ЭлектроПласт» является направление «Источники питания». Мы предлагаем Вам помощь Конструкторского отдела:

- Подбор оптимального решения, техническое обоснование при выборе компонента;
- Подбор аналогов;
- Консультации по применению компонента;
- Поставка образцов и прототипов;
- Техническая поддержка проекта;
- Защита от снятия компонента с производства.



Как с нами связаться

Телефон: 8 (812) 309 58 32 (многоканальный)

Факс: 8 (812) 320-02-42

Электронная почта: org@eplast1.ru

Адрес: 198099, г. Санкт-Петербург, ул. Калинина, дом 2, корпус 4, литера А.