



V4 83170 Dual-current 831708 Part number 83170805



- Nominal ratings 0.1 A to 10 A / 250 VAC
- Minimum rating 1 mA / 4 VDC
- Operating temperature up to +125 °C
- Conforming to standards EN 61058 and UL 1054
- Choice of actuators with 2 possible fixing positions

Part numbers

Type	Function	Connections
83170805 Dual-current 831708	I (changeover)	W7A5

Specifications

Electrical characteristics

Rating nominal / 250 VAC (A)	0,1
Rating thermal / 250 VAC (A)	6

Mechanical characteristics

Maximum operating force (N)	1,5
Min. Release force (N)	0,3
Maximum total travel force (N)	1,8
Max. permitted overtravel force (N)	10
Maximum rest position (mm)	9,2
Operating position (mm)	8,4 \pm 0,3
Max. differential travel mm	0,15
Min. overtravel (mm)	0,5
Ambient operating temperature (°C)	-20 \rightarrow +125
Mechanical life (operations)	10 ⁶
Contact gap (mm)	0,4
Weight (g)	1,7

Additional specifications

Components

Material

- Case : polyester UL 94 VO
- Button : Glass-filled polyamide
- Contacts : AgNi, gold-plated AgNi (dual-current)
- Terminals : cupro-nickel (except W7A5 in brass)

Levers

- Flat : stainless steel
- Roller : stainless steel, polyamide roller

Approvals

NF - UL - cUL

Principles

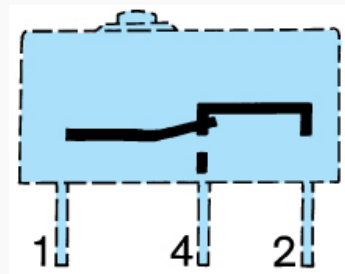

Dimensions (mm)

Product

83170
Asymmetrical version

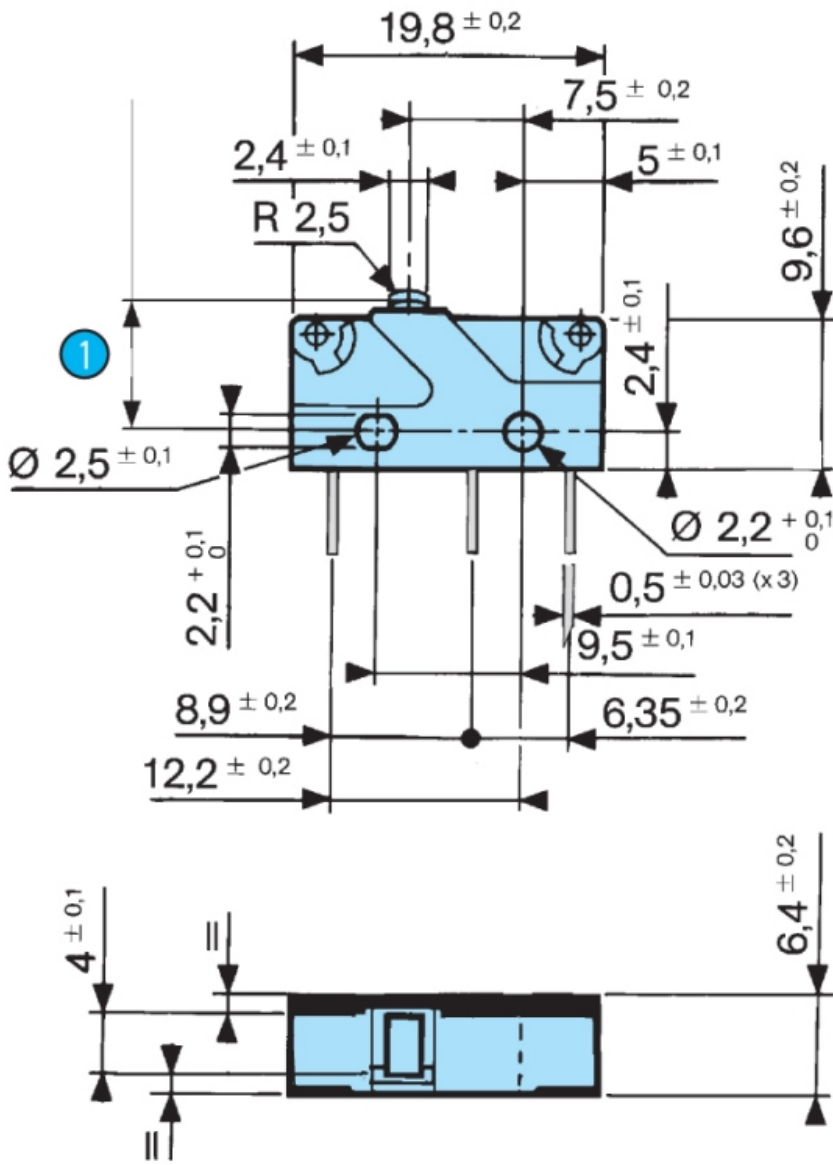

N°	Legend
1	OL = 7.6

Dimensions (mm)

Product

83170 Symmetrical version

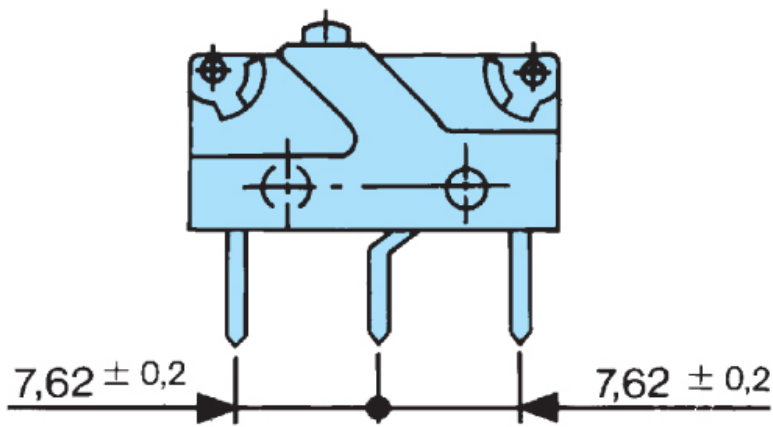

Dimensions (mm)

Connections

W2

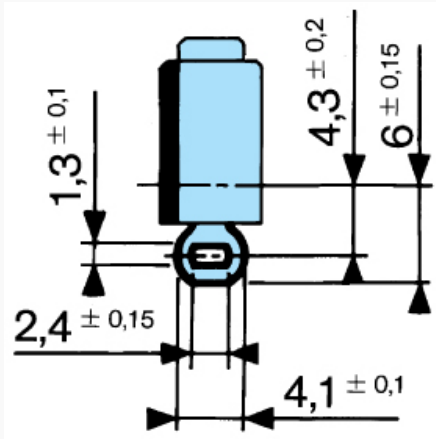

Dimensions (mm)

Connections

W7A5

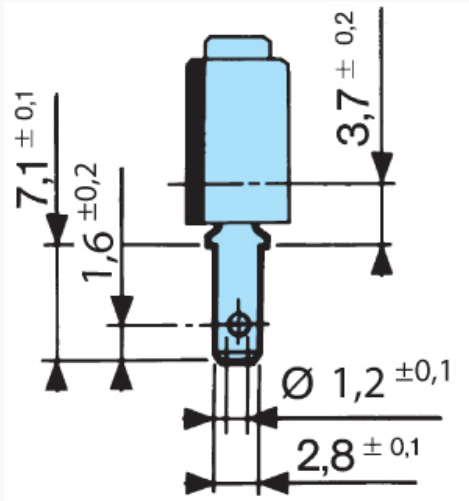

Dimensions (mm)

Connections

X1 - X1S

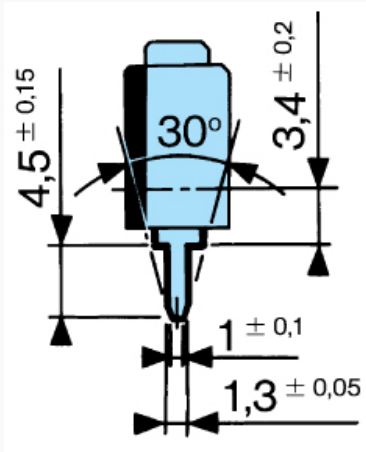

Dimensions (mm)

Connections

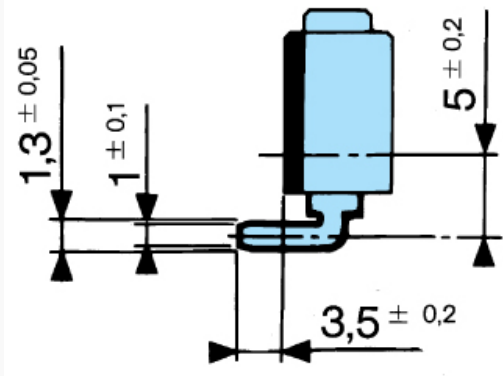

Dimensions (mm)

Connections

X3 - X3S

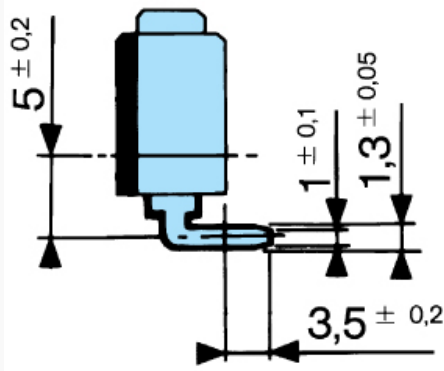

Dimensions (mm)

Drilling

Printed circuit board mounting
Asymmetrical X1 - X2 - X3

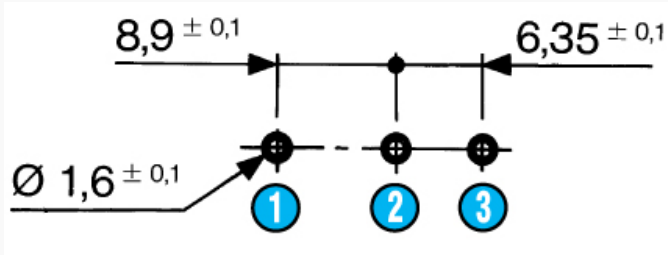

N°	Legend
1	1.C
2	4.NO
3	2.NC

Dimensions (mm)

Drilling

Printed circuit board mounting
Symmetrical X1S - X2S - X3S

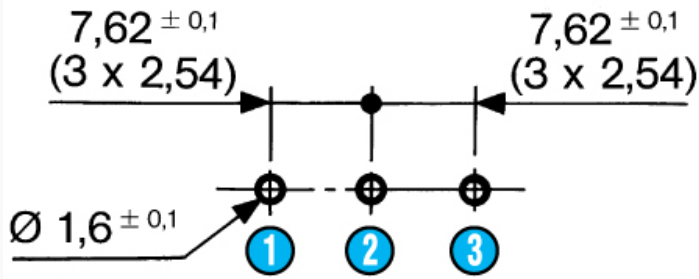

N°	Legend
1	1.C
2	4.NO
3	2.NC

Dimensions (mm)

Drilling

Mounting on a printed circuit board with fixing pins
Asymmetrical

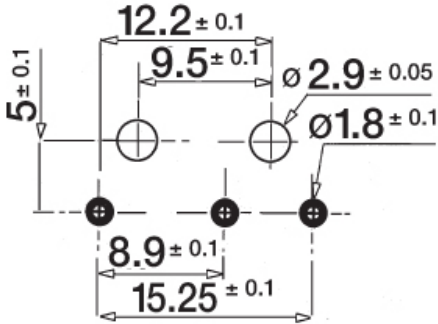

Dimensions (mm)

Drilling

Mounting on a printed circuit board with fixing pins
Symmetrical

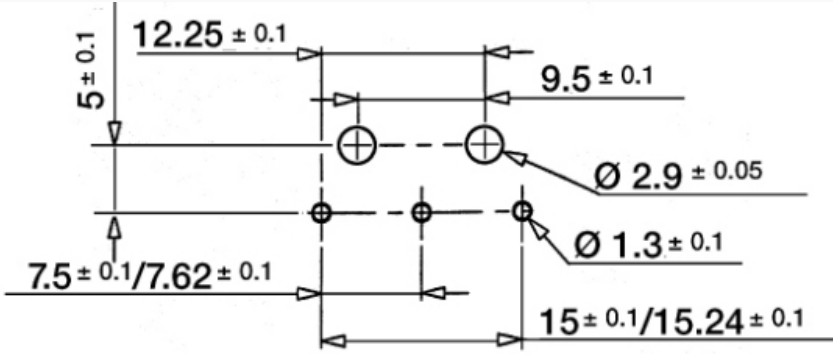

Dimensions (mm)

Actuator mounting positions

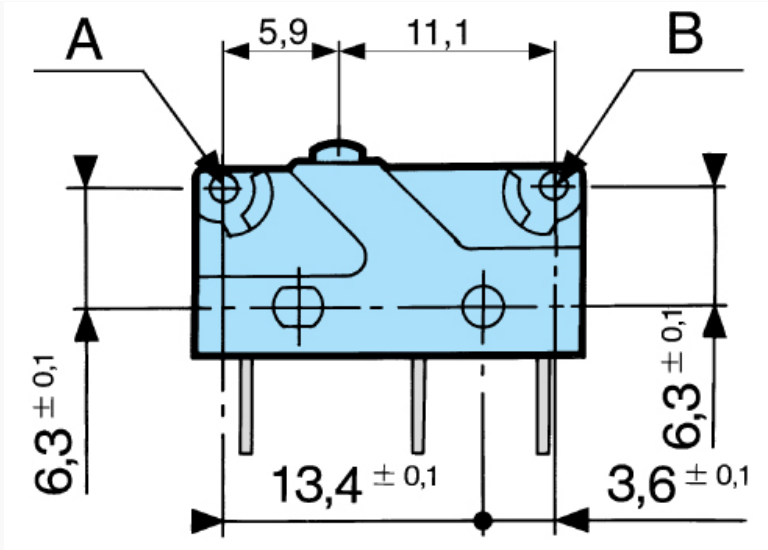

Fixing position Except where otherwise indicated, levers are supplied unmounted. For factory mounting, specify fixing position A or B. To calculate force : divide the switch force by the coefficient in the table. To calculate travel : multiply the switch travel by the same coefficient.

Dimensions (mm)

Actuators

170A

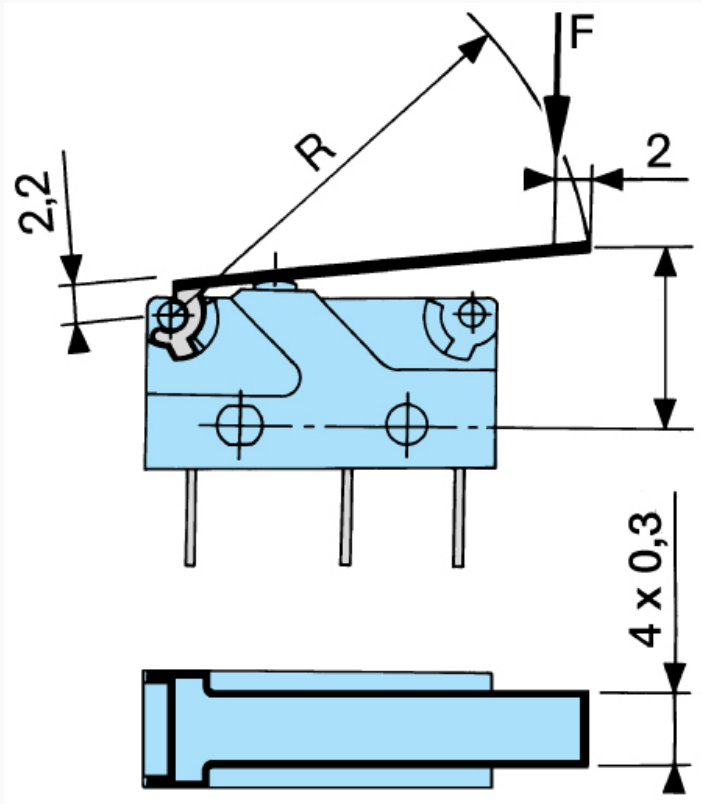

Fixing position Except where otherwise indicated, levers are supplied unmounted. For factory mounting, specify fixing position A or B. To calculate force : divide the switch force by the coefficient in the table. To calculate travel : multiply the switch travel by the same coefficient.

Dimensions (mm)

Actuators

170E

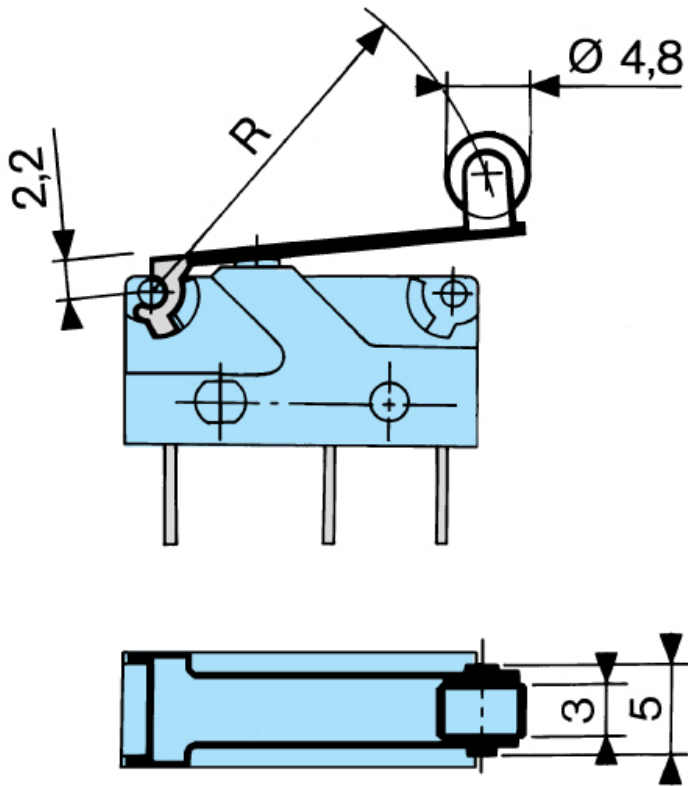

Fixing position Except where otherwise indicated, levers are supplied unmounted. For factory mounting, specify fixing position A or B. To calculate force : divide the switch force by the coefficient in the table. To calculate travel : multiply the switch travel by the same coefficient.

Dimensions (mm)

Actuators

170F

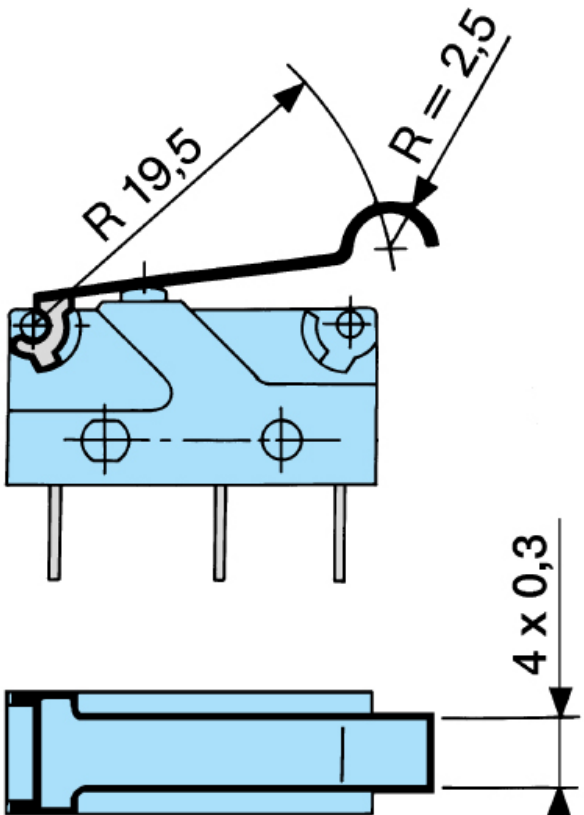

Fixing position Except where otherwise indicated, levers are supplied unmounted. For factory mounting, specify fixing position A or B. To calculate force : divide the switch force by the coefficient in the table. To calculate travel : multiply the switch travel by the same coefficient.

Dimensions (mm)

Actuators

Fixing pins

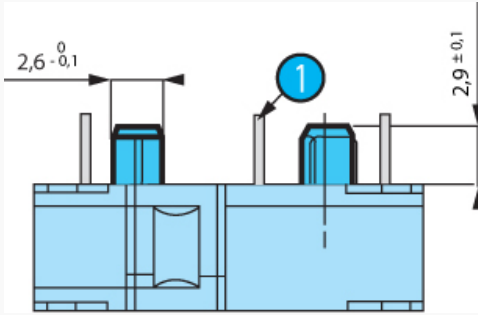

Fixing position Except where otherwise indicated, levers are supplied unmounted. For factory mounting, specify fixing position A or B. To calculate force : divide the switch force by the coefficient in the table. To calculate travel : multiply the switch travel by the same coefficient.

N°	Legend
①	Output on unit side : X2

Dimensions (mm)

Actuators

Fixing pins

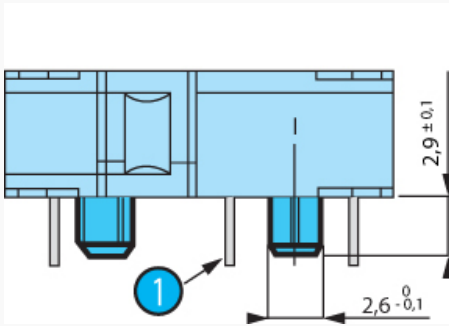

Fixing position Except where otherwise indicated, levers are supplied unmounted. For factory mounting, specify fixing position A or B. To calculate force : divide the switch force by the coefficient in the table. To calculate travel : multiply the switch travel by the same coefficient.

N°	Legend
①	Output on cover side : X3

Curves

Operating curve for types 831708 / 831709

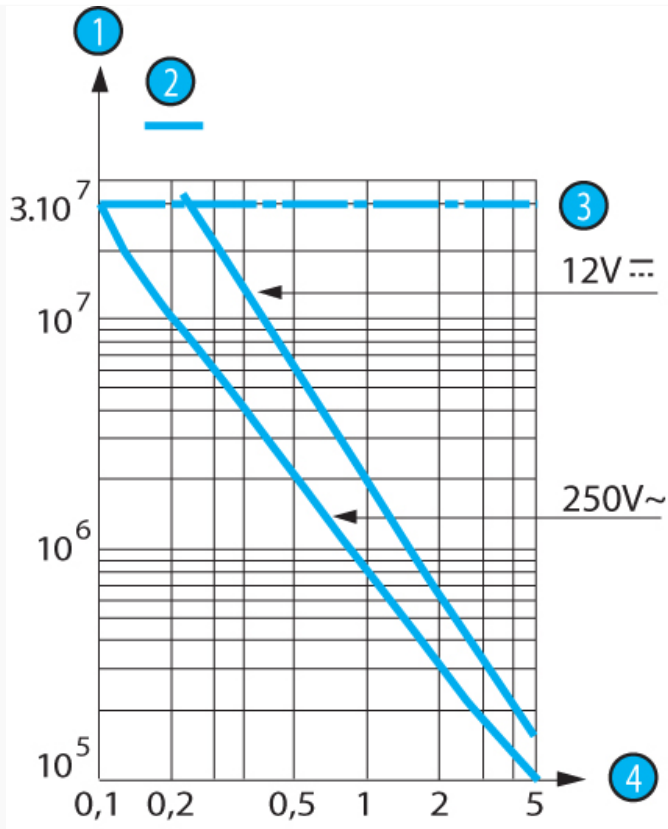

Models 831708 and 831709 are designed to operate equally well on dual-current (1 mA 4 V minimum) or medium-current (5 A maximum) circuits. However, a given product should only be used to switch one type of circuit during its working life.

N°	Legend
1	Number of cycles
2	Resistive circuit
3	Mechanical life limit
4	Current in Amps

Connections

Actuators and fixing positions

Part numbers for standard actuators	79253327	79253326	79253328	79218454	79253329	
Actuators	Flat 170A R18.3	Flat 170A R24	Flat 170A R41	Roller 170E R20	Dummy roller 170F	
Fixing positions						
Coefficient	A B	A B	A B	A B	A B	
Tripping point	3 1.5	4 2	7 3.5	3 1.5	3 1.5	
	10 ^{+1.4}	9.2 ^{+0.9}	10.7 ^{+1.7} 9.6 ⁺¹	12.7 ^{+1.8} 10.6 ^{+1.8}	15.5 ^{+1.4} 14.5 ^{+0.9}	12.9 ^{+1.3} 11.9 ^{+1.1}
Levers	Screw 170D		Transverse roller 170EL			
	Characteristics available on request					

Other information

Mounting - Operation

See basic technical concepts

Product adaptations



- Special levers
- Special connections



Компания «ЭлектроПласт» предлагает заключение долгосрочных отношений при поставках импортных электронных компонентов на взаимовыгодных условиях!

Наши преимущества:

- Оперативные поставки широкого спектра электронных компонентов отечественного и импортного производства напрямую от производителей и с крупнейших мировых складов;
- Поставка более 17-ти миллионов наименований электронных компонентов;
- Поставка сложных, дефицитных, либо снятых с производства позиций;
- Оперативные сроки поставки под заказ (от 5 рабочих дней);
- Экспресс доставка в любую точку России;
- Техническая поддержка проекта, помощь в подборе аналогов, поставка прототипов;
- Система менеджмента качества сертифицирована по Международному стандарту ISO 9001;
- Лицензия ФСБ на осуществление работ с использованием сведений, составляющих государственную тайну;
- Поставка специализированных компонентов (Xilinx, Altera, Analog Devices, Intersil, Interpoint, Microsemi, Aeroflex, Peregrine, Syfer, Eurofarad, Texas Instrument, Miteq, Cobham, E2V, MA-COM, Hittite, Mini-Circuits, General Dynamics и др.);

Помимо этого, одним из направлений компании «ЭлектроПласт» является направление «Источники питания». Мы предлагаем Вам помощь Конструкторского отдела:

- Подбор оптимального решения, техническое обоснование при выборе компонента;
- Подбор аналогов;
- Консультации по применению компонента;
- Поставка образцов и прототипов;
- Техническая поддержка проекта;
- Защита от снятия компонента с производства.



Как с нами связаться

Телефон: 8 (812) 309 58 32 (многоканальный)

Факс: 8 (812) 320-02-42

Электронная почта: org@eplast1.ru

Адрес: 198099, г. Санкт-Петербург, ул. Калинина, дом 2, корпус 4, литера А.