



- Pletronics' THD3002-20.0M is a temperature compensated crystal oscillator
- Optional Voltage Control Function
- HCMOS output.
- The package is designed for high density surface mount designs.
- Tape and Reel packaging is available.
- Select Stratum-III frequencies available
- 3.2 x 5 mm LCC Ceramic Package
- Tape and Reel packaging is available.
- Select Stratum-III frequencies available

**Pletronics Inc. certifies this device is in accordance with the
RoHS 6/6 (2002/95/EC) and WEEE (2002/96/EC) directives.**

Pletronics Inc. guarantees the device does not contain the following:
Cadmium, Hexavalent Chromium, Lead, Mercury, PBB's, PBDE's
Weight of the Device: 0.10 grams
Moisture Sensitivity Level: 1 As defined in J-STD-020D.1
Second Level Interconnect code: e4

Absolute Maximum Ratings:

Parameter	Unit
V _{CC} Supply Voltage	-0.5V to +6.5V
V _i Input Voltage	-0.5V to V _{CC} + 0.5V
V _o Output Voltage	-0.5V to V _{CC} + 0.5V

Thermal Characteristics

The maximum die or junction temperature is 155°C
The thermal resistance junction to board is 30 to 50°C/Watt depending on the solder pads, ground plane and construction of the PCB.

ESD Rating

Model	Minimum Voltage	Conditions
Human Body Model	1500	MIL-STD-883 Method 3115
Charged Device Model	1000	JESD 22-C101

Electrical Specification for specified Vcc over the specified temperature range

Item	Min	TYP	Max	Unit	Condition	
Frequency Range		20.0		MHz		
Frequency Stability vs Temp.	-0.28		+0.28	ppm	Vcontrol = 1.50 volts (Fmax-Fmin)/2	
24 Hour Holdover	-0.37		0.37	ppm	GR-1244-CORE	
Frequency Calibration	-0.5		+0.5	ppm	Frequency offset at 25°C, 60 minutes after reflow	
Frequency Stability / Supply	-0.10		+0.10	ppm	Load: 10K ohm // 10 pF & Vcc ± 5%	
Load Sensitivity	-0.20		+0.20	ppm	±2% variation in magnitude from 10K ohm ±10% 10 pF	
Long Term Stability (Aging)	-3.4		+3.4	ppm	After 15 years.	
Output Waveform	CMOS					
Output V _{HIGH} as % of Supply	90			%V _S	Load: 10K ohm ± 10% // 10 pF	
Output V _{LOW} as % of Supply			10	%V _S		
T _{RISE} and T _{FALL} (10% to 90%)			6.5	nS		
Duty Cycle at 50% Supply	40	50	60	%		
Phase Noise	10 Hz 100 Hz 1 kHz 10 kHz	- - - -	-90 -115 -135 -145	- - - -	dBc/Hz	Typical values for a 20.0 MHz oscillator at 25°C
Jitter	-	-	1.7	pS	10 Hz to 1 MHz offset from carrier	
V Supply Range V _{CC}	2.8	-	5.5	Volts		
Supply Current I _{CC}	-	-	7.0	mA		
Vcontrol Range	0.5		2.50	Volts	1.50 volts nominal	
Frequency Pullability	± 9.2	± 10.0	-	ppm		
Linearity	-	0.05	2.0	%	In accordance with MIL-PRF-55310	
Operating Temperature Range	-40		+85	°C	Specified by part number	
Storage Temperature Range	-55		+95	°C		

Phase Noise:

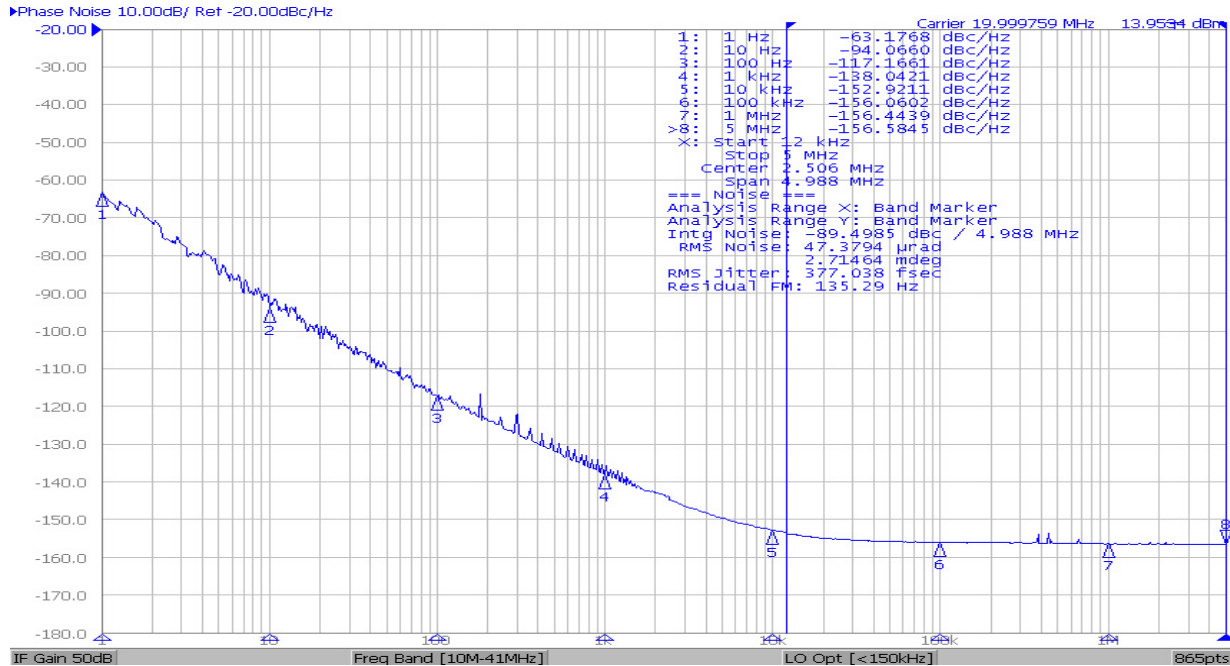

MTIE:

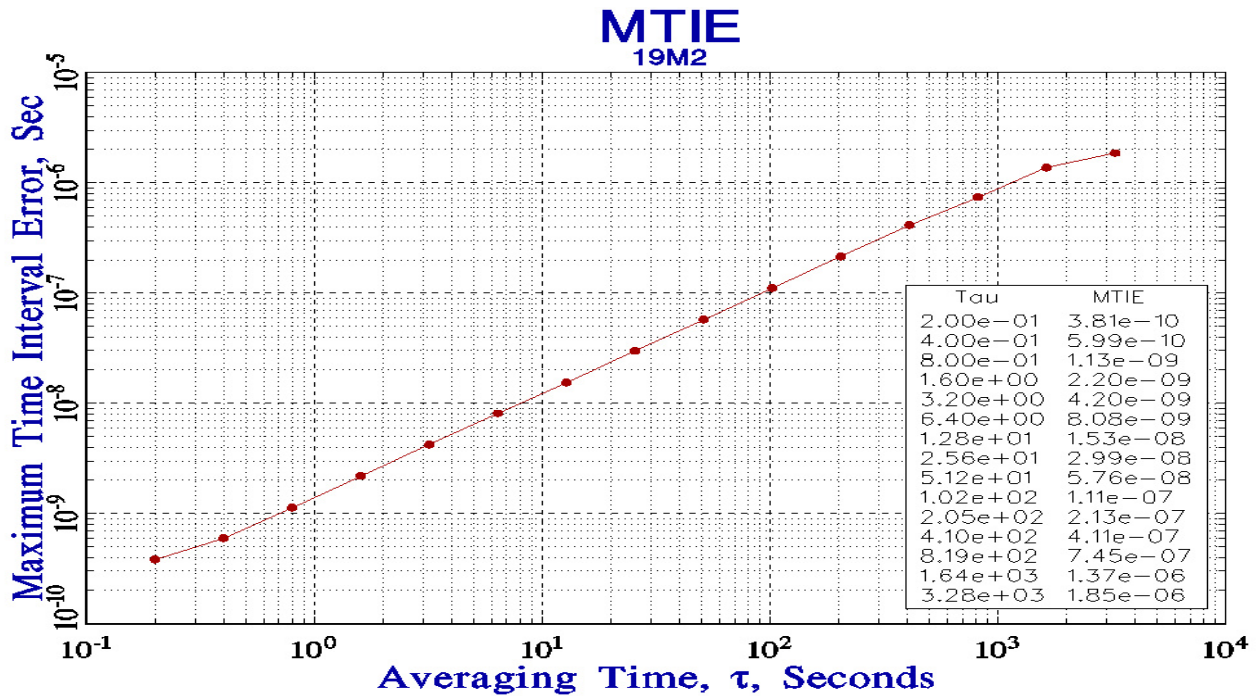

Reliability: Environmental Compliance

Parameter	Condition
Mechanical Shock	MIL-STD-883 Method 2002, Condition B
Vibration	MIL-STD-883 Method 2007, Condition A
Solderability	MIL-STD-883 Method 2003
Thermal Shock	MIL-STD-883 Method 1011, Condition A

Package Labeling

P/N: 
 THD3002-20.0M
Customer P/N: 
 12345678
Qty:  1000 **D/C** 
 TC512SA
 MSL: 1

RoHS Compliant
 2nd LvL Interconnect
 Category=e4
 Max Safe Temp=260C for 10s 2X Max

Label is 1" x 2.6" (25.4mm x 66.7mm)
 Font is Courier New
 Bar code is 39-Full ASCII

Label is 1" x 2.6" (25.4mm x 66.7mm)
 Font is Arial

Part Marking:

fff.yww
 • PLExx.xxxx

or

fff.yww
 • PLExx.xxxx

fff.yww = frequency in MHz . Year week
PLE = Pletronics
xx.xxxx = internal code

Mechanical:

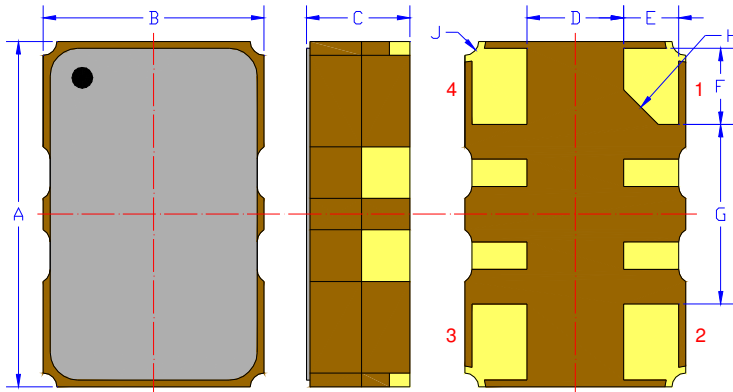

	Inches	mm
A	0.197 ±0.008	5.00 ±0.20
B	0.126 ±0.008	3.20 ±0.20
C	0.059 max	1.50 max
D ¹	0.055	1.40
E ¹	0.031	0.80
F ¹	0.043	1.10
G ¹	0.102	2.60
H ¹	0.013C	0.50C
J ¹	0.008	0.20R

Pad	Function	Note
1	Vcontrol Input	If this function is not specified, recommend connecting this pad to ground.
2	Ground (GND)	
3	Output	
4	Supply Voltage (V _{CC})	Connect an appropriate power supply bypass capacitors as close as possible.
-	N. C.	All other pads on the bottom shall not be connected. These are internally connected and were for the TCXO compensation process

Layout and application information

All connection points in the designated region have solder mask cover to avoid any electrical connections

For Optimum Stability and Jitter Performance, Pletronics recommends:

- a ground plane under the device
- no large transient signals (both current and voltage) should be routed under the device
- do not layout near a large magnetic field such as a high frequency switching power supply
- do not place near piezoelectric buzzers or mechanical fans.
- minimize air flow across the device

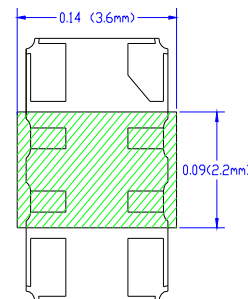

Reflow Cycle (typical for lead free processing)

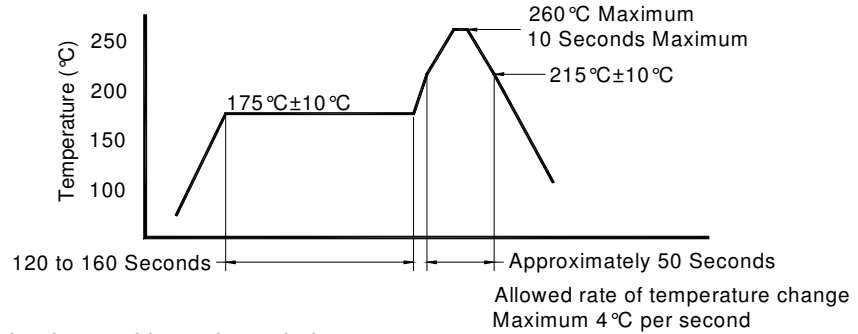

The part may be reflowed 2 times without degradation.

Tape and Reel: available for quantities of 250 to 1000 per reel, cut tape for < 250

Constant Dimensions Table 1								
Tape Size	D0	D1 Min	E1	P0	P2	S1 Min	T Max	T1 Max
8mm	1.5	1.0	1.75	4.0	2.0 ±0.05	0.6	0.6	0.1
12mm		1.5			2.0 ±0.1			
16mm		+0.1 -0.0			±0.1			
24mm		1.5			±0.1			

Variable Dimensions Table 2							
Tape Size	B1 Max	E2 Min	F	P1	T2 Max	W Max	Ao, Bo & Ko
16 mm	12.1	14.25	7.5 ± 0.1	8.0 ± 0.1	8.0	16.3	Note 1

Note 1: Embossed cavity to conform to EIA-481-B Dimensions in mm Not to scale

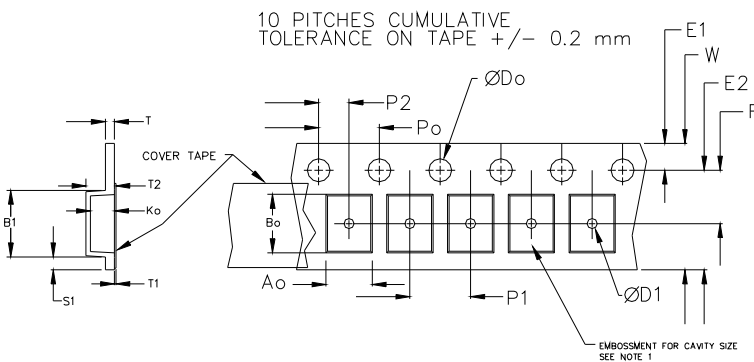
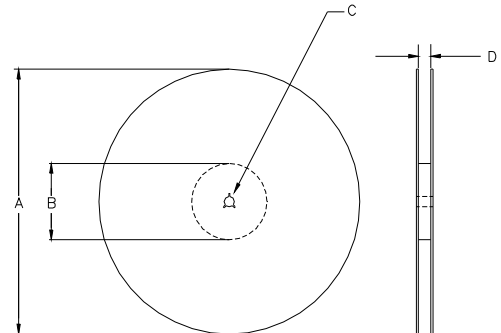

REEL DIMENSIONS					
A	inches	7.0	10.0	13.0	Tape Width
	mm	177.8	254.0	330.2	
B	inches	2.50	4.00	3.75	Tape Width
	mm	63.5	101.6	95.3	
C	mm	13.0 +0.5 / -0.2			Tape Width
D	mm	16.4 +2.0 -0.0	16.4 +2.0 -0.0	16.4 +2.0 -0.0	

Reel dimensions may vary from the above

USER DIRECTION OF UNREELING →

IMPORTANT NOTICE

Pletronics Incorporated (PLE) reserves the right to make corrections, improvements, modifications and other changes to this product at anytime. PLE reserves the right to discontinue any product or service without notice. Customers are responsible for obtaining the latest relevant information before placing orders and should verify that such information is current and complete. All products are sold subject to PLE's terms and conditions of sale supplied at the time of order acknowledgment.

PLE warrants performance of this product to the specifications applicable at the time of sale in accordance with PLE's limited warranty. Testing and other quality control techniques are used to the extent PLE deems necessary to support this warranty. Except where mandated by specific contractual documents, testing of all parameters of each product is not necessarily performed.

PLE assumes no liability for application assistance or customer product design. Customers are responsible for their products and applications using PLE components. To minimize the risks associated with the customer products and applications, customers should provide adequate design and operating safeguards.

PLE products are not designed, intended, authorized or warranted to be suitable for use in life support applications, devices or systems or other critical applications that may involve potential risks of death, personal injury or severe property or environmental damage. Inclusion of PLE products in such applications is understood to be fully at the risk of the customer. Use of PLE products in such applications requires the written approval of an appropriate PLE officer. Questions concerning potential risk applications should be directed to PLE.

PLE does not warrant or represent that any license, either express or implied, is granted under any PLE patent right, copyright, artwork or other intellectual property right relating to any combination, machine or process which PLE product or services are used. Information published by PLE regarding third-party products or services does not constitute a license from PLE to use such products or services or a warranty or endorsement thereof. Use of such information may require a license from a third party under the patents or other intellectual property of the third party, or a license from PLE under the patents or other intellectual property of PLE.

Reproduction of information in PLE data sheets or web site is permissible only if the reproduction is without alteration and is accompanied by associated warranties, conditions, limitations and notices. Reproduction of this information with alteration is an unfair and deceptive business practice. PLE is not responsible or liable for such altered documents.

Resale of PLE products or services with statements different from or beyond the parameters stated by PLE for that product or service voids all express and implied warranties for the associated PLE product or service and is an unfair or deceptive business practice. PLE is not responsible for any such statements.

Contacting Pletronics Inc.

Pletronics Inc.
19013 36th Ave. West
Lynnwood, WA 98036-5761 USA

Tel: 425-776-1880
Fax: 425-776-2760
E-mail: ple-sales@pletronics.com
URL: www.pletronics.com

Copyright © 2011, Pletronics Inc.



Компания «ЭлектроПласт» предлагает заключение долгосрочных отношений при поставках импортных электронных компонентов на взаимовыгодных условиях!

Наши преимущества:

- Оперативные поставки широкого спектра электронных компонентов отечественного и импортного производства напрямую от производителей и с крупнейших мировых складов;
- Поставка более 17-ти миллионов наименований электронных компонентов;
- Поставка сложных, дефицитных, либо снятых с производства позиций;
- Оперативные сроки поставки под заказ (от 5 рабочих дней);
- Экспресс доставка в любую точку России;
- Техническая поддержка проекта, помощь в подборе аналогов, поставка прототипов;
- Система менеджмента качества сертифицирована по Международному стандарту ISO 9001;
- Лицензия ФСБ на осуществление работ с использованием сведений, составляющих государственную тайну;
- Поставка специализированных компонентов (Xilinx, Altera, Analog Devices, Intersil, Interpoint, Microsemi, Aeroflex, Peregrine, Syfer, Eurofarad, Texas Instrument, Miteq, Cobham, E2V, MA-COM, Hittite, Mini-Circuits, General Dynamics и др.);

Помимо этого, одним из направлений компании «ЭлектроПласт» является направление «Источники питания». Мы предлагаем Вам помощь Конструкторского отдела:

- Подбор оптимального решения, техническое обоснование при выборе компонента;
- Подбор аналогов;
- Консультации по применению компонента;
- Поставка образцов и прототипов;
- Техническая поддержка проекта;
- Защита от снятия компонента с производства.



Как с нами связаться

Телефон: 8 (812) 309 58 32 (многоканальный)

Факс: 8 (812) 320-02-42

Электронная почта: org@eplast1.ru

Адрес: 198099, г. Санкт-Петербург, ул. Калинина, дом 2, корпус 4, литера А.