

---

---

## 300 mA, 16V, High-Performance LDO

---

---

### Features:

- High PSRR: >70 dB @ 1 kHz, typical
- 68.0  $\mu$ A Typical Quiescent Current
- Input Operating Voltage Range: 3.6V to 16.0V
- 300 mA Output Current for all Output Voltages
- Low Dropout Voltage, 300 mV typical @ 300 mA
- Standard Output Voltage Options (1.8V, 2.5V, 2.8V, 3.0V, 3.3V, 4.0V, 5.0V)
- Output Voltage Range 1.8V to 5.5V in 0.1V Increments (tighter increments are also possible per design)
- Output Voltage Tolerances of  $\pm 2.0\%$  over entire Temperature Range
- Stable with Minimum 1.0  $\mu$ F Output Capacitance
- Power Good Output
- Shutdown Input
- True Current Foldback Protection
- Short-Circuit Protection
- Overtemperature Protection

### Applications:

- Battery-powered Devices
- Battery-powered Alarm Circuits
- Smoke Detectors
- CO<sub>2</sub> Detectors
- Pagers and Cellular Phones
- Smart Battery Packs
- Portable Digital Assistant (PDA)
- Digital Cameras
- Microcontroller Power
- Consumer Products
- Battery-powered Data Loggers

### Related Literature:

- AN765, “Using Microchip’s Micropower LDOs” (DS00765), Microchip Technology Inc., 2007
- AN766, “Pin-Compatible CMOS Upgrades to BiPolar LDOs” (DS00766), Microchip Technology Inc., 2003
- AN792, “A Method to Determine How Much Power a SOT-23 Can Dissipate in an Application” (DS00792), Microchip Technology Inc., 2001

### Description:

The MCP1755/1755S is a family of CMOS low-dropout (LDO) voltage regulators that can deliver up to 300 mA of current while consuming only 68.0  $\mu$ A of quiescent current (typical). The input operating range is specified from 3.6V to 16.0V, making it an ideal choice for four to six primary cell battery-powered applications, 12V mobile applications and one to three cell Li-Ion-powered applications.

The MCP1755/1755S is capable of delivering 300 mA with only 300 mV (typical) of input-to-output voltage differential. The output voltage tolerance of the MCP1755 is typically +0.85% at +25°C and  $\pm 2.0\%$  maximum over the operating junction temperature range of -40°C to +125°C. Line regulation is  $\pm 0.01\%$  typical at +25°C.

Output voltages available for the MCP1755/1755S range from 1.8V to 5.5V. The LDO output is stable when using only 1  $\mu$ F of output capacitance. Ceramic, tantalum or aluminum electrolytic capacitors may all be used for input and output. Overcurrent limit and overtemperature shutdown provide a robust solution for any application.

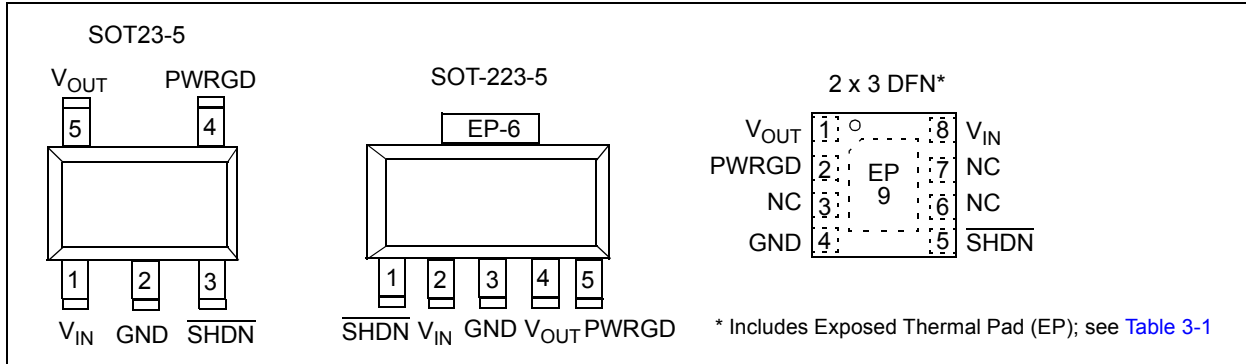
The MCP1755/1755S family has a true current foldback feature. When the load impedance decreases beyond the MCP1755/1755S load rating, the output current and voltage will gracefully foldback towards 30 mA at about 0V output. When the load impedance increases and returns to the rated load, the MCP1755/1755S will follow the same foldback curve as the device comes out of current foldback.

Package options for the MCP1755 include the SOT-23-5, SOT-223-5 and 8-lead 2 x 3 DFN.

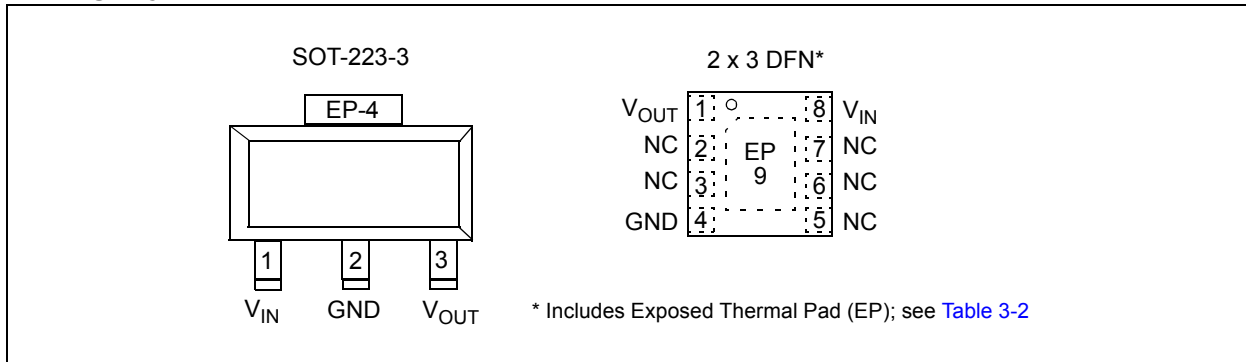
Package options for the MCP1755S device include the SOT-223-3 and 8-lead 2 x 3 DFN.

# MCP1755/1755S

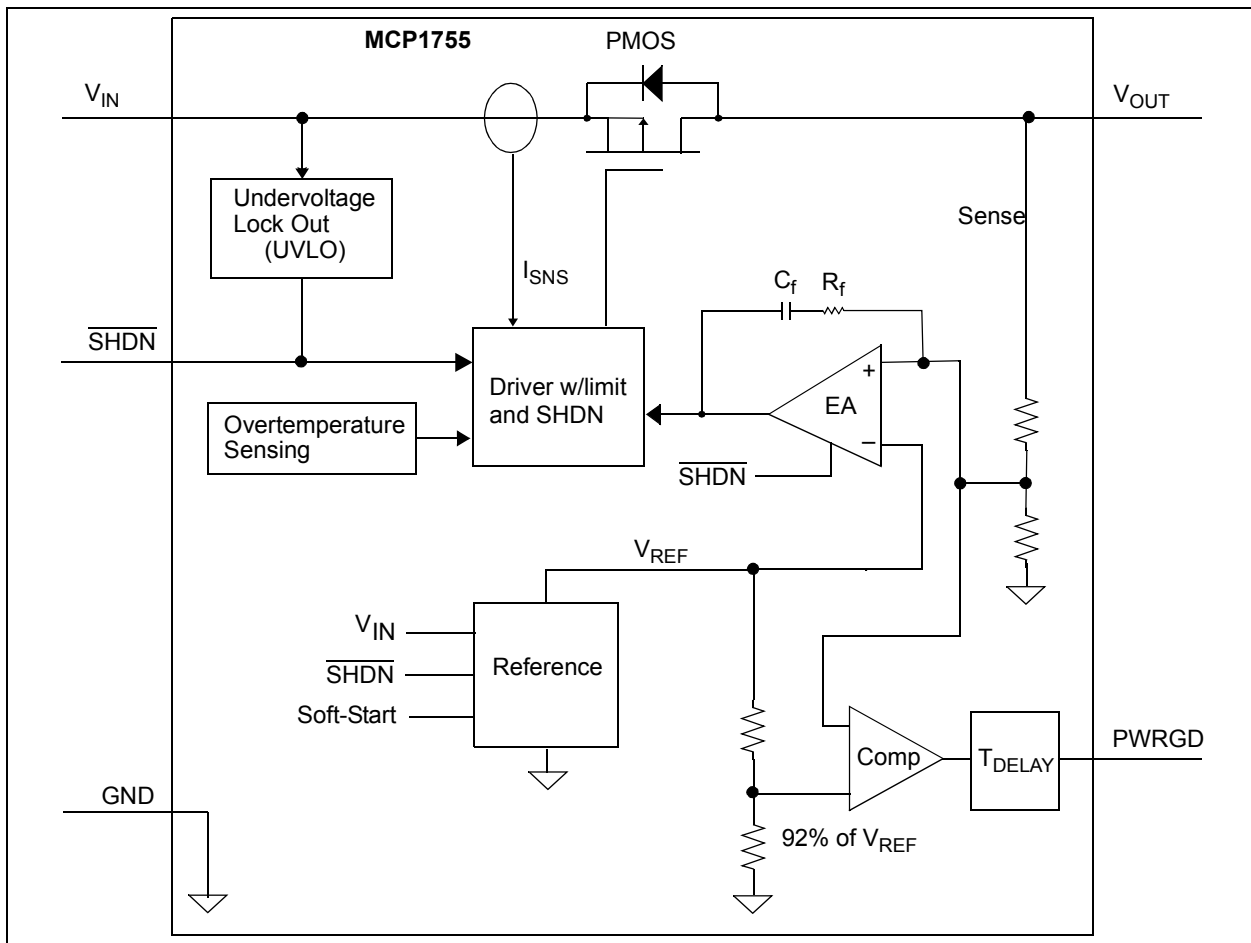
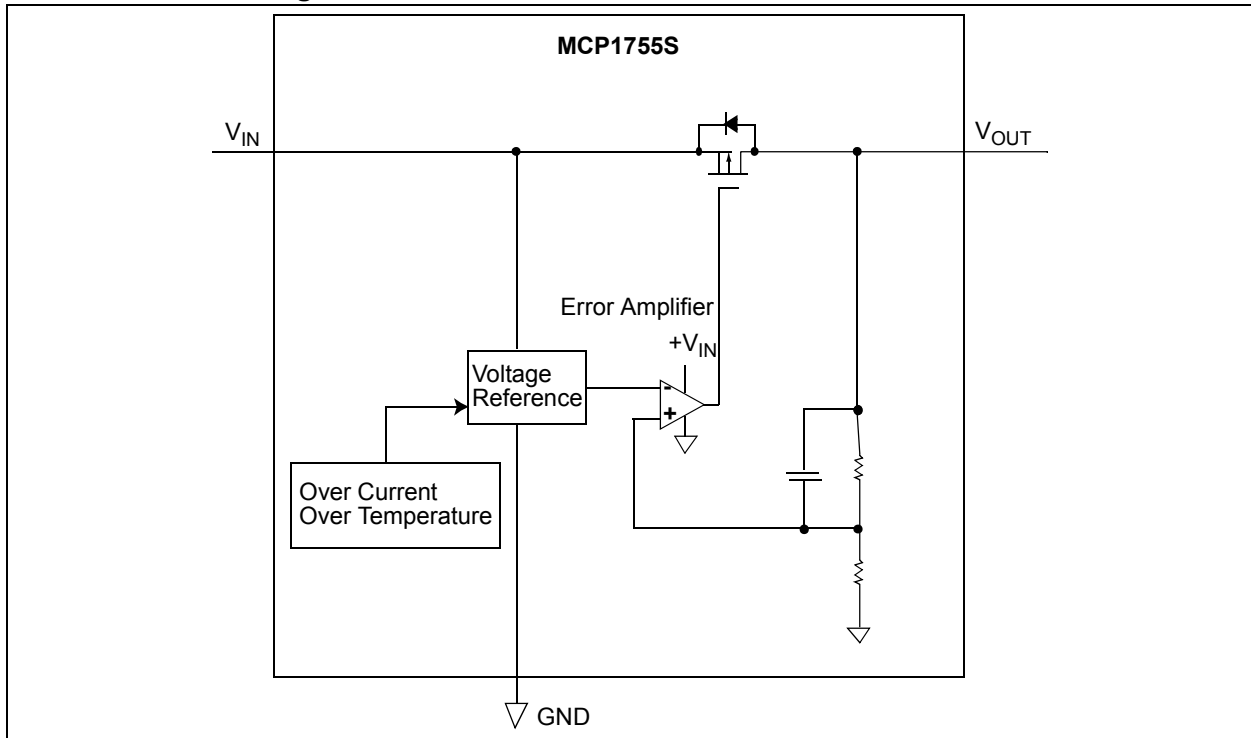
## Package Types – MCP1755



## Package Types – MCP1755S

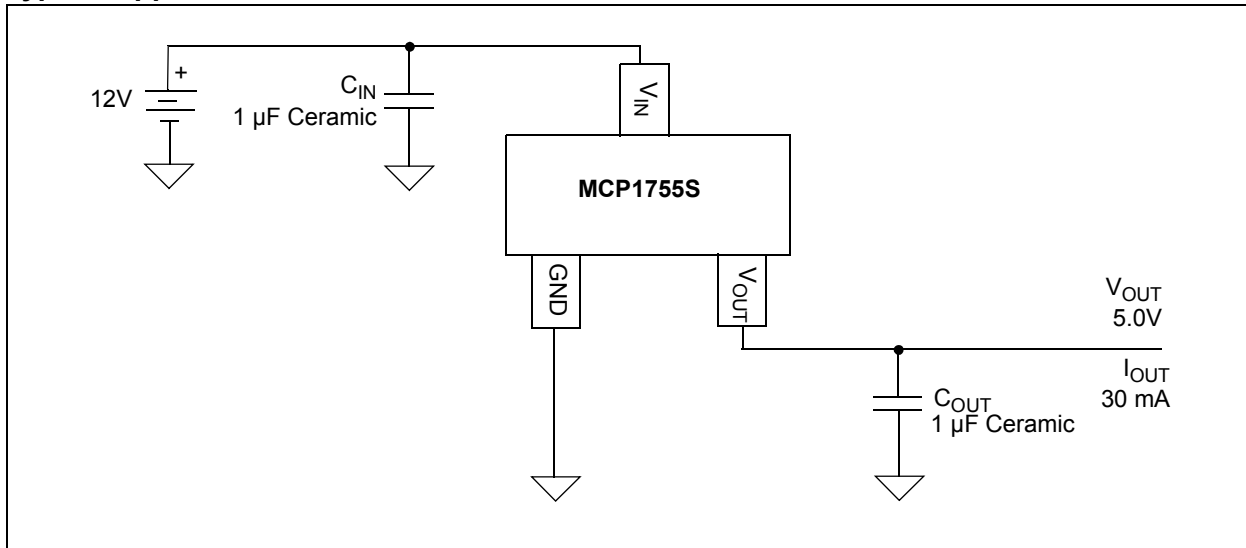


## Functional Block Diagrams



# MCP1755/1755S

## Typical Application Circuits



## 1.0 ELECTRICAL CHARACTERISTICS

### Absolute Maximum Ratings †

Input Voltage, $V_{IN}$ .....	+17.6V
$V_{IN}$ , PWRGD, SHDN.....	(GND – 0.3V) to ( $V_{IN}$ + 0.3V)
$V_{OUT}$ .....	(GND – 0.3V) to (+5.5V)
Internal Power Dissipation .....	Internally-Limited ( <b>Note 6</b> )
Output Short Circuit Current .....	Continuous
Storage temperature .....	-55°C to +150°C
Maximum Junction Temperature.....	+165°C ( <b>Note 7</b> )
Operating Junction Temperature.....	-40°C to +150°C
ESD protection on all pins.....	≥3 kV HBM and ≥400V MM

† **Notice:** Stresses above those listed under “Maximum Ratings” may cause permanent damage to the device. This is a stress rating only and functional operation of the device at those or any other conditions above those indicated in the operational listings of this specification is not implied. Exposure to maximum rating conditions for extended periods may affect device reliability.

### AC/DC CHARACTERISTICS

**Electrical Specifications:** Unless otherwise specified, all limits are established for  $V_{IN} = V_R + 1V$ , **Note 1**,  $I_{LOAD} = 1\text{ mA}$ ,  $C_{OUT} = 1\text{ }\mu\text{F}$  (X7R),  $C_{IN} = 1\text{ }\mu\text{F}$  (X7R),  $T_A = +25^\circ\text{C}$ ,  $t_{r(VIN)} = 0.5\text{ V}/\mu\text{s}$ , SHDN =  $V_{IN}$ , PWRGD = 10K to  $V_{OUT}$ . **Boldface type** applies for junction temperatures,  $T_J$  (**Note 7**) of -40°C to +125°C.

Parameters	Sym.	Min.	Typ.	Max.	Units	Conditions
<b>Input/Output Characteristics</b>						
Input Operating Voltage	$V_{IN}$	<b>3.6</b>	—	<b>16.0</b>	V	
Output Voltage Operating Range	$V_{OUT-RANGE}$	<b>1.8</b>	—	<b>5.5</b>	V	
Input Quiescent Current	$I_q$	—	68	<b>100</b>	$\mu\text{A}$	$I_L = 0\text{ mA}$
Input Quiescent Current for SHDN mode	$I_{SHDN}$	—	0.1	<b>4</b>	$\mu\text{A}$	SHDN = GND
Ground Current	$I_{GND}$	—	300	<b>400</b>	$\mu\text{A}$	$I_{LOAD} = 300\text{ mA}$
Maximum Output Current	$I_{OUT\_mA}$	<b>300</b>	—	—	mA	
Output Soft Current Limit	SCL	—	450	—	mA	$V_{OUT} \geq 0.1V$ , $V_{IN} = V_{IN(MIN)}$ , Current measured 10 ms after the load is applied
Output Pulse Current Limit	PCL	—	350	—	mA	Pulse Duration < 100 ms, Duty Cycle < 50%, $V_{OUT} \geq 0.1V$ , <b>Note 6</b>
Output Short Circuit Foldback Current	$I_{OUT\_SC}$	—	30	—	mA	$V_{IN} = V_{IN(MIN)}$ , $V_{OUT} = GND$
Output Voltage Overshoot on Start-up	$V_{OVER}$	—	0.5	—	% $V_{OUT}$	$V_{IN} = 0$ to 16V, $I_{LOAD} = 300\text{ mA}$

- Note 1:** The minimum  $V_{IN}$  must meet two conditions:  $V_{IN} \geq 3.6V$  and  $V_{IN} \geq V_R + V_{DROPOUT(MAX)}$ .
- 2:**  $V_R$  is the nominal regulator output voltage when the input voltage  $V_{IN} = V_{Rated} + V_{DROPOUT(MAX)}$  or  $V_{IN} = 3.6V$  (whichever is greater);  $I_{OUT} = 1\text{ mA}$ .
- 3:**  $TCV_{OUT} = (V_{OUT-HIGH} - V_{OUT-LOW}) \times 10^6 / (V_R \times \Delta_{Temperature})$ ,  $V_{OUT-HIGH}$  = highest voltage measured over the temperature range.  $V_{OUT-LOW}$  = lowest voltage measured over the temperature range.
- 4:** Load regulation is measured at a constant junction temperature using low duty-cycle pulse testing. Changes in output voltage due to heating effects are determined using thermal regulation specification  $TCV_{OUT}$ .
- 5:** Dropout voltage is defined as the input to output differential at which the output voltage drops 2% below the output voltage value that was measured with an applied input voltage of  $V_{IN} = V_R + 1V$  or  $V_{IN} = 3.6V$  (whichever is greater).
- 6:** The maximum allowable power dissipation is a function of ambient temperature, the maximum allowable junction temperature and the thermal resistance from junction to air (i.e.,  $T_A$ ,  $T_J$ ,  $\theta_{JA}$ ). Exceeding the maximum allowable power dissipation will cause the device operating junction temperature to exceed the maximum +150°C rating. Sustained junction temperatures above +150°C can impact the device reliability.
- 7:** The junction temperature is approximated by soaking the device under test at an ambient temperature equal to the desired junction temperature. The test time is small enough such that the rise in the junction temperature over the ambient temperature is not significant.
- 8:** See **Section 4.6 “Shutdown Input (SHDN)”** and **Figure 2-34**.

# MCP1755/1755S

## AC/DC CHARACTERISTICS (CONTINUED)

**Electrical Specifications:** Unless otherwise specified, all limits are established for  $V_{IN} = V_R + 1V$ , **Note 1**,  $I_{LOAD} = 1\text{ mA}$ ,  $C_{OUT} = 1\text{ }\mu\text{F}$  (X7R),  $C_{IN} = 1\text{ }\mu\text{F}$  (X7R),  $T_A = +25^\circ\text{C}$ ,  $t_{r(VIN)} = 0.5\text{ V}/\mu\text{s}$ ,  $\overline{\text{SHDN}} = V_{IN}$ ,  $\text{PWRGD} = 10\text{K to } V_{OUT}$ . **Boldface** type applies for junction temperatures,  $T_J$  (**Note 7**) of  $-40^\circ\text{C}$  to  $+125^\circ\text{C}$ .

Parameters	Sym.	Min.	Typ.	Max.	Units	Conditions
Output Voltage Regulation	$V_{OUT}$	<b><math>V_R - 2.0\%</math></b>	$V_R + 0.85\%$	<b><math>V_R + 2.0\%</math></b>	V	<b>Note 2</b>
$V_{OUT}$ Temperature Coefficient	$\text{TCV}_{OUT}$	—	35		ppm/ $^\circ\text{C}$	<b>Note 3</b>
Line Regulation	$\frac{\Delta V_{OUT}}{(V_{OUT} \times \Delta V_{IN})}$	<b>-0.05</b>	$\pm 0.01$	<b>+0.05</b>	%/V	$V_R + 1V \leq V_{IN} \leq 16V$
Load Regulation	$\Delta V_{OUT}/V_{OUT}$	<b>-0.5</b>	$\pm 0.1$	<b>+0.5</b>	%	$I_L = 1.0\text{ mA to } 300\text{ mA}$ , <b>Note 4</b>
Dropout Voltage ( <b>Note 5</b> )	$V_{DROPOUT}$	—	300	<b>500</b>	mV	$I_L = 300\text{ mA}$
Dropout Current	$I_{DO}$	—	75	<b>120</b>	$\mu\text{A}$	$V_{IN} = 0.95V_R$ , $I_{OUT} = 0\text{ mA}$
<b>Undervoltage Lockout</b>						
Undervoltage Lockout	UVLO	—	3.0	—	V	Rising $V_{IN}$
Undervoltage Lockout Hysteresis	$\text{UVLO}_{HYS}$	—	300	—	mV	Falling $V_{IN}$
<b>Shutdown Input</b>						
Logic High Input	$V_{SHDN-HIGH}$	<b>2.4</b>	—	$V_{IN(MAX)}$	V	
Logic Low Input	$V_{SHDN-LOW}$	0.0	—	<b>0.8</b>	V	
Shutdown Input Leakage Current	$\overline{\text{SHDN}}_{ILK}$	—	0.02	<b>0.2</b>	$\mu\text{A}$	$\overline{\text{SHDN}} = 16V$
<b>Power Good Output</b>						
PWRGD Input Voltage Operating Range	$V_{PWRGD\_VIN}$	<b>1.7</b>	—	$V_{IN}$	V	$I_{SINK} = 1\text{ mA}$
PWRGD Threshold Voltage (Referenced to $V_{OUT}$ )	$V_{PWRGD\_TH}$	<b>90</b>	92	<b>94</b>	% $V_{OUT}$	Falling Edge of $V_{OUT}$
PWRGD Threshold Hysteresis	$V_{PWRGD\_HYS}$	—	2.0	—	% $V_{OUT}$	Rising Edge of $V_{OUT}$
PWRGD Output Voltage Low	$V_{PWRGD\_L}$	—	0.2	<b>0.45</b>	V	$I_{PWRGD\_SINK} = 5.0\text{ mA}$ , $V_{OUT} = 0V$
PWRGD Output Sink Current	$I_{PWRGD\_L}$	<b>5.0</b>	—	—	mA	$V_{PWRGD} \leq 0.45V$

- Note 1:** The minimum  $V_{IN}$  must meet two conditions:  $V_{IN} \geq 3.6V$  and  $V_{IN} \geq V_R + V_{DROPOUT(MAX)}$ .
- Note 2:**  $V_R$  is the nominal regulator output voltage when the input voltage  $V_{IN} = V_{Rated} + V_{DROPOUT(MAX)}$  or  $V_{IN} = 3.6V$  (whichever is greater);  $I_{OUT} = 1\text{ mA}$ .
- Note 3:**  $\text{TCV}_{OUT} = (V_{OUT-HIGH} - V_{OUT-LOW}) \times 10^6 / (V_R \times \Delta\text{Temperature})$ ,  $V_{OUT-HIGH}$  = highest voltage measured over the temperature range.  $V_{OUT-LOW}$  = lowest voltage measured over the temperature range.
- Note 4:** Load regulation is measured at a constant junction temperature using low duty-cycle pulse testing. Changes in output voltage due to heating effects are determined using thermal regulation specification  $\text{TCV}_{OUT}$ .
- Note 5:** Dropout voltage is defined as the input to output differential at which the output voltage drops 2% below the output voltage value that was measured with an applied input voltage of  $V_{IN} = V_R + 1V$  or  $V_{IN} = 3.6V$  (whichever is greater).
- Note 6:** The maximum allowable power dissipation is a function of ambient temperature, the maximum allowable junction temperature and the thermal resistance from junction to air (i.e.,  $T_A$ ,  $T_J$ ,  $\theta_{JA}$ ). Exceeding the maximum allowable power dissipation will cause the device operating junction temperature to exceed the maximum  $+150^\circ\text{C}$  rating. Sustained junction temperatures above  $+150^\circ\text{C}$  can impact the device reliability.
- Note 7:** The junction temperature is approximated by soaking the device under test at an ambient temperature equal to the desired junction temperature. The test time is small enough such that the rise in the junction temperature over the ambient temperature is not significant.
- Note 8:** See **Section 4.6 “Shutdown Input (SHDN)”** and **Figure 2-34**.

# MCP1755/1755S

## AC/DC CHARACTERISTICS (CONTINUED)

**Electrical Specifications:** Unless otherwise specified, all limits are established for  $V_{IN} = V_R + 1V$ , **Note 1**,  $I_{LOAD} = 1\text{ mA}$ ,  $C_{OUT} = 1\text{ }\mu\text{F}$  (X7R),  $C_{IN} = 1\text{ }\mu\text{F}$  (X7R),  $T_A = +25^\circ\text{C}$ ,  $t_{r(VIN)} = 0.5\text{ V}/\mu\text{s}$ ,  $\overline{\text{SHDN}} = V_{IN}$ ,  $\text{PWRGD} = 10\text{K}$  to  $V_{OUT}$ . **Boldface** type applies for junction temperatures,  $T_J$  (**Note 7**) of  $-40^\circ\text{C}$  to  $+125^\circ\text{C}$ .

Parameters	Sym.	Min.	Typ.	Max.	Units	Conditions
PWRGD Leakage Current	$I_{\text{PWRGD\_LK}}$	—	50	<b>200</b>	nA	$V_{\text{PWRGD}}$ Pullup = 10 k $\Omega$ to $V_{IN}$ $V_{IN} = 16\text{V}$
PWRGD Time Delay	$T_{\text{PG}}$	—	100	—	$\mu\text{s}$	Rising Edge of $V_{OUT}$
Detect Threshold to PWRGD Active Time Delay	$T_{\text{VDET\_PWRGD}}$	—	200	—	$\mu\text{s}$	Falling Edge of $V_{OUT}$ after Transition from $V_{OUT} = V_{\text{PWRGD\_TH}} + 50\text{ mV}$ to $V_{\text{PWRGD\_TH}} - 50\text{ mV}$ , $R_{\text{PULLUP}} = 10\text{ k}\Omega$ to $V_{IN}$
<b>AC Performance</b>						
Output Delay from $V_{IN}$ to $V_{OUT} = 90\% V_{\text{REG}}$	$T_{\text{DELAY}}$	—	200	—	$\mu\text{s}$	$V_{IN} = 0\text{V}$ to 16V, $V_{OUT} = 90\% V_R$ , $t_{r(VIN)} = 5\text{ V}/\mu\text{s}$ ,
Output Delay From $V_{IN}$ to $V_{OUT} > 0.1\text{V}$	$T_{\text{DELAY\_START}}$	—	80	—	$\mu\text{s}$	$V_{IN} = 0\text{V}$ to 16V, $V_{OUT} \geq 0.1\text{V}$ , $t_{r(VIN)} = 5\text{ V}/\mu\text{s}$ ,
Output Delay From SHDN ( <b>Note 8</b> )	$T_{\text{DELAY\_SHDN}}$	—	235	—	$\mu\text{s}$	$V_{IN} = 6\text{V}$ , $V_{OUT} = 90\% V_R$ , $V_R = 5\text{V}$ , $\text{SHDN} = \text{GND}$ to $V_{IN}$
		—	940	—	$\mu\text{s}$	$V_{IN} = 7\text{V}$ , $V_{OUT} = 90\% V_R$ , $V_R = 5\text{V}$ , $\text{SHDN} = \text{GND}$ to $V_{IN}$
		—	210	—	$\mu\text{s}$	$V_{IN} = 16\text{V}$ , $V_{OUT} = 90\% V_R$ , $V_R = 5\text{V}$ , $\text{SHDN} = \text{GND}$ to $V_{IN}$
Output Noise	$e_N$	—	0.3	—	$\mu\text{V}/(\sqrt{\text{Hz}})$	$I_L = 50\text{ mA}$ , $f = 1\text{ kHz}$ ,
Power Supply Ripple Rejection Ratio	PSRR	—	80	—	dB	$V_R = 5\text{V}$ , $f = 1\text{ kHz}$ , $I_L = 100\text{ mA}$ , $V_{\text{INAC}} = 1\text{V}_{\text{PK-PK}}$ , $C_{IN} = 0\text{ }\mu\text{F}$ , $V_{IN} \geq V_R + 1.5\text{V} \geq 3.6\text{V}$
Thermal Shutdown Temperature	$T_{\text{SD}}$	—	150	—	$^\circ\text{C}$	<b>Note 6</b>
Thermal Shutdown Hysteresis	$\Delta T_{\text{SD}}$	—	10	—	$^\circ\text{C}$	

- Note 1:** The minimum  $V_{IN}$  must meet two conditions:  $V_{IN} \geq 3.6\text{V}$  and  $V_{IN} \geq V_R + V_{\text{DROPOUT(MAX)}}$ .
- 2:**  $V_R$  is the nominal regulator output voltage when the input voltage  $V_{IN} = V_{\text{Rated}} + V_{\text{DROPOUT(MAX)}}$  or  $V_{IN} = 3.6\text{V}$  (whichever is greater);  $I_{OUT} = 1\text{ mA}$ .
- 3:**  $\text{TCV}_{\text{OUT}} = (V_{\text{OUT-HIGH}} - V_{\text{OUT-LOW}}) \times 10^6 / (V_R \times \Delta\text{Temperature})$ ,  $V_{\text{OUT-HIGH}}$  = highest voltage measured over the temperature range.  $V_{\text{OUT-LOW}}$  = lowest voltage measured over the temperature range.
- 4:** Load regulation is measured at a constant junction temperature using low duty-cycle pulse testing. Changes in output voltage due to heating effects are determined using thermal regulation specification  $\text{TCV}_{\text{OUT}}$ .
- 5:** Dropout voltage is defined as the input to output differential at which the output voltage drops 2% below the output voltage value that was measured with an applied input voltage of  $V_{IN} = V_R + 1\text{V}$  or  $V_{IN} = 3.6\text{V}$  (whichever is greater).
- 6:** The maximum allowable power dissipation is a function of ambient temperature, the maximum allowable junction temperature and the thermal resistance from junction to air (i.e.,  $T_A$ ,  $T_J$ ,  $\theta_{JA}$ ). Exceeding the maximum allowable power dissipation will cause the device operating junction temperature to exceed the maximum  $+150^\circ\text{C}$  rating. Sustained junction temperatures above  $+150^\circ\text{C}$  can impact the device reliability.
- 7:** The junction temperature is approximated by soaking the device under test at an ambient temperature equal to the desired junction temperature. The test time is small enough such that the rise in the junction temperature over the ambient temperature is not significant.
- 8:** See **Section 4.6 “Shutdown Input (SHDN)”** and **Figure 2-34**.

# MCP1755/1755S

## TEMPERATURE SPECIFICATIONS (Note 1)

Parameters	Sym.	Min.	Typ.	Max.	Units	Conditions
<b>Temperature Ranges</b>						
Specified Temperature Range	$T_A$	-40	—	+125	°C	
Operating Temperature Range	$T_J$	-40	—	+150	°C	
Storage Temperature Range	$T_A$	-55	—	+150	°C	
<b>Thermal Package Resistance</b>						
Thermal Resistance, SOT-223-3	$\theta_{JA}$	—	62	—	°C/W	
	$\theta_{JC}$	—	15	—		
Thermal Resistance, SOT-223-5	$\theta_{JA}$	—	62	—	°C/W	
	$\theta_{JC}$	—	15	—		
Thermal Resistance, SOT-23-5	$\theta_{JA}$	—	256	—	°C/W	
	$\theta_{JC}$	—	81	—		
Thermal Resistance, 2 x 3 DFN-8	$\theta_{JA}$	—	70	—	°C/W	
	$\theta_{JC}$	—	13.4	—		

**Note 1:** The maximum allowable power dissipation is a function of ambient temperature, the maximum allowable junction temperature and the thermal resistance from junction to air (i.e.,  $T_A$ ,  $T_J$ ,  $\theta_{JA}$ ). Exceeding the maximum allowable power dissipation will cause the device operating junction temperature to exceed the maximum +150°C rating. Sustained junction temperatures above +150°C can impact the device reliability.

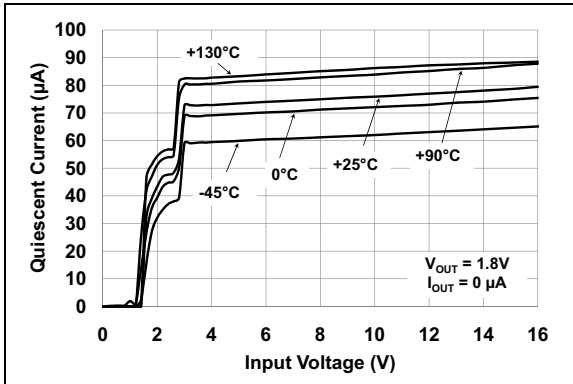


## 2.0 TYPICAL PERFORMANCE CURVES

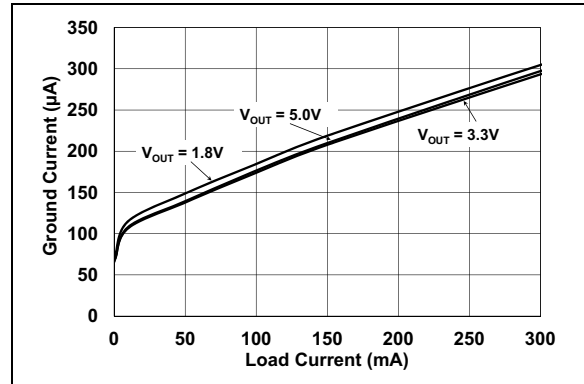
**Note:** The graphs and tables provided following this note are a statistical summary based on a limited number of samples and are provided for informational purposes only. The performance characteristics listed herein are not tested or guaranteed. In some graphs or tables, the data presented may be outside the specified operating range (e.g., outside specified power supply range) and therefore outside the warranted range.

**Note 1:** Unless otherwise indicated  $V_R = 3.3V$ ,  $C_{OUT} = 1 \mu F$  Ceramic (X7R),  $C_{IN} = 1 \mu F$  Ceramic (X7R),  $I_L = 1 mA$ ,  $T_A = +25^\circ C$ ,  $V_{IN} = V_R + 1V$  or  $V_{IN} = 3.6V$  (whichever is greater),  $\overline{SHDN} = V_{IN}$ , package = SOT-223.

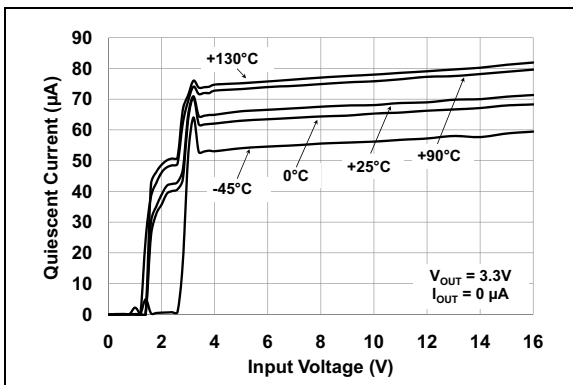
**2:** Junction Temperature ( $T_J$ ) is approximated by soaking the device under test to an ambient temperature equal to the desired junction temperature. The test time is small enough such that the rise in junction temperature over the ambient temperature is not significant.



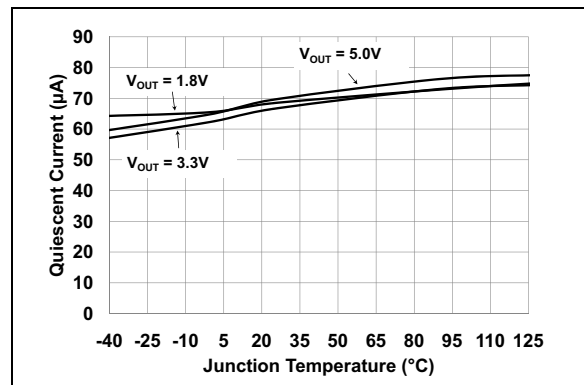
**FIGURE 2-1:** Quiescent Current vs. Input Voltage.



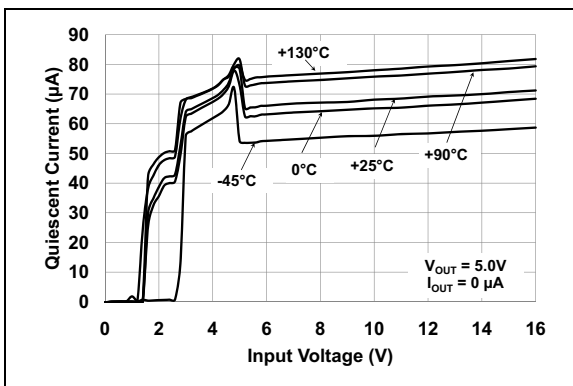
**FIGURE 2-4:** Ground Current vs. Load Current.



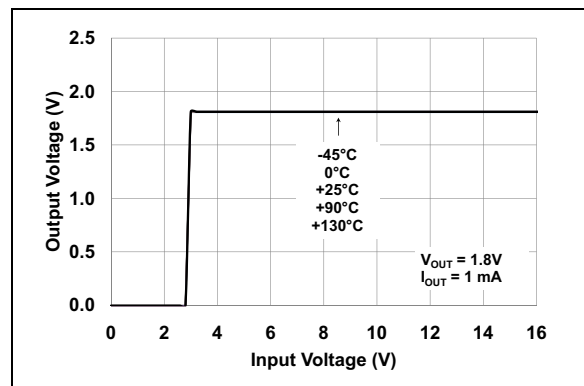
**FIGURE 2-2:** Quiescent Current vs. Input Voltage.



**FIGURE 2-5:** Quiescent Current vs. Junction Temperature.



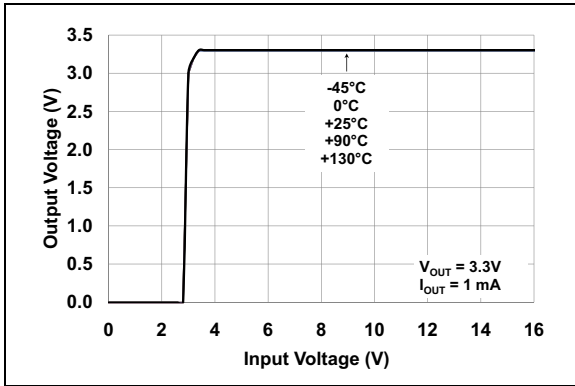
**FIGURE 2-3:** Quiescent Current vs. Input Voltage.



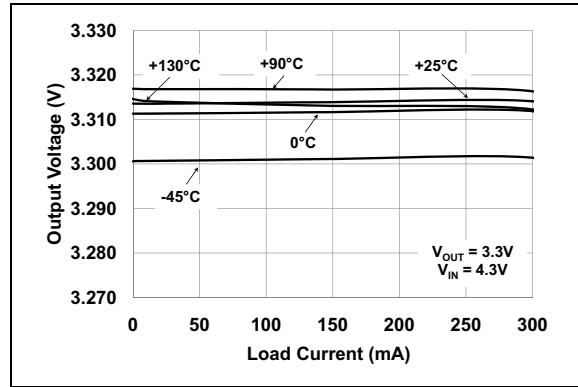
**FIGURE 2-6:** Output Voltage vs. Input Voltage.

# MCP1755/1755S

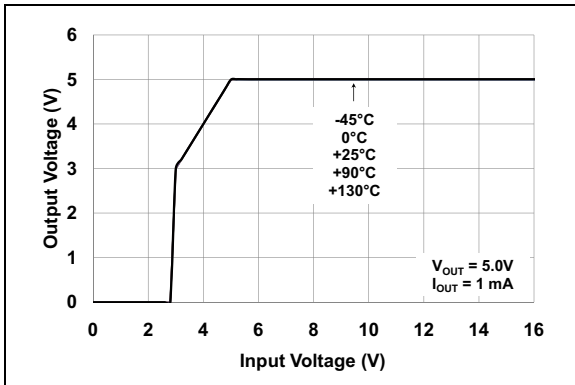
**Note 1:** Unless otherwise indicated  $V_R = 3.3V$ ,  $C_{OUT} = 1 \mu F$  Ceramic (X7R),  $C_{IN} = 1 \mu F$  Ceramic (X7R),  $I_L = 1 mA$ ,  $T_A = +25^\circ C$ ,  $V_{IN} = V_R + 1V$  or  $V_{IN} = 3.6V$  (whichever is greater),  $SHDN = V_{IN}$ , package = SOT-223



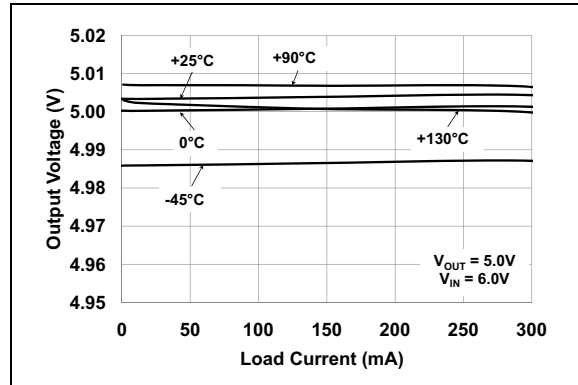
**FIGURE 2-7:** Output Voltage vs. Input Voltage.



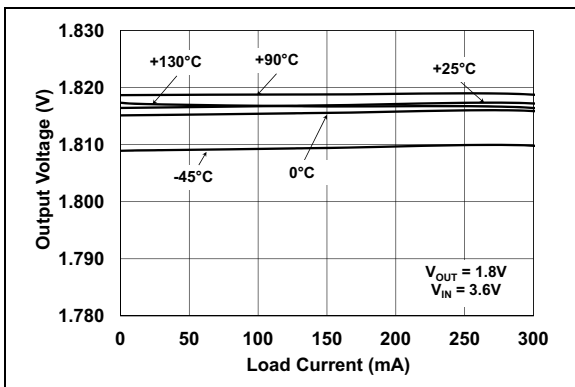
**FIGURE 2-10:** Output Voltage vs. Load Current.



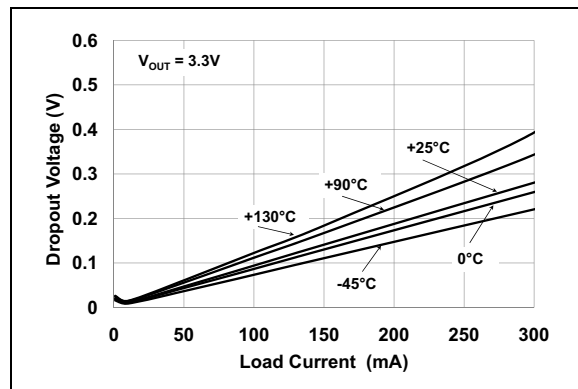
**FIGURE 2-8:** Output Voltage vs. Input Voltage.



**FIGURE 2-11:** Output Voltage vs. Load Current.

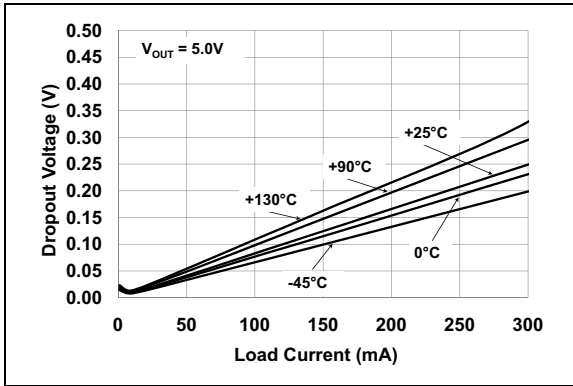


**FIGURE 2-9:** Output Voltage vs. Load Current.

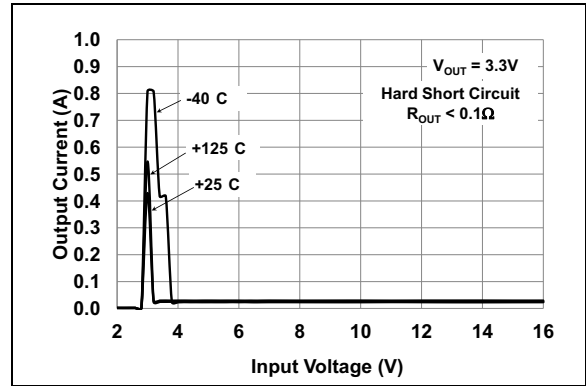


**FIGURE 2-12:** Dropout Voltage vs. Load Current.

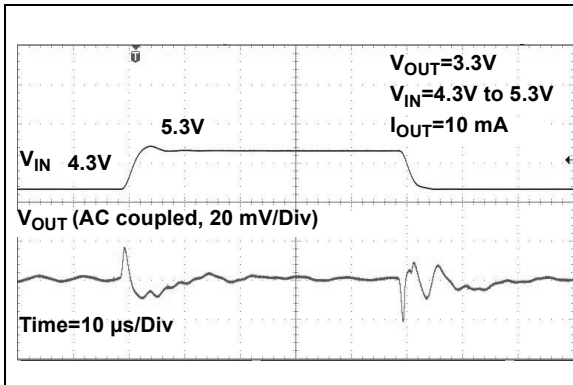
**Note 1:** Unless otherwise indicated  $V_R = 3.3V$ ,  $C_{OUT} = 1 \mu F$  Ceramic (X7R),  $C_{IN} = 1 \mu F$  Ceramic (X7R),  $I_L = 1 mA$ ,  $T_A = +25^\circ C$ ,  $V_{IN} = V_R + 1V$  or  $V_{IN} = 3.6V$  (whichever is greater),  $\overline{SHDN} = V_{IN}$ , package = SOT-223



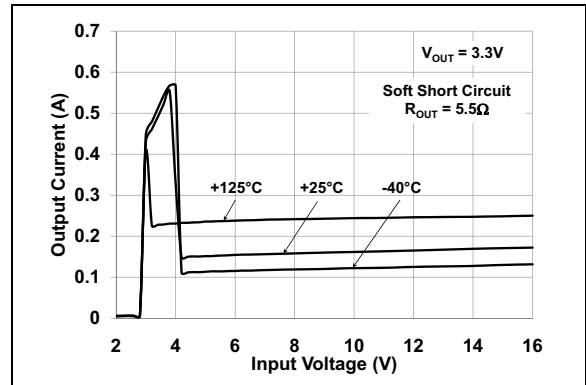
**FIGURE 2-13:** Dropout Voltage vs. Load Current.



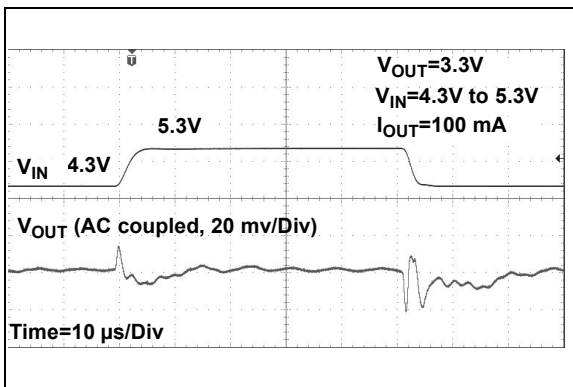
**FIGURE 2-16:** Short Circuit Current vs. Input Voltage.



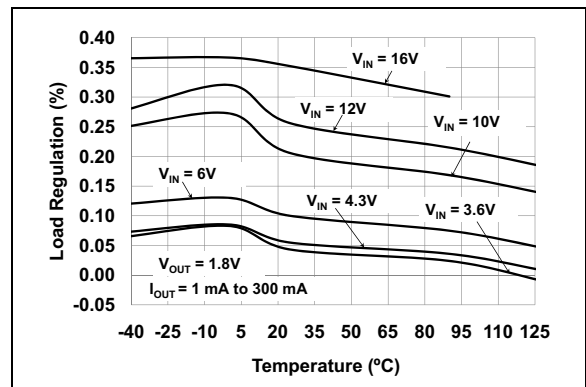
**FIGURE 2-14:** Dynamic Line Response.



**FIGURE 2-17:** Short Circuit Current vs. Input Voltage.



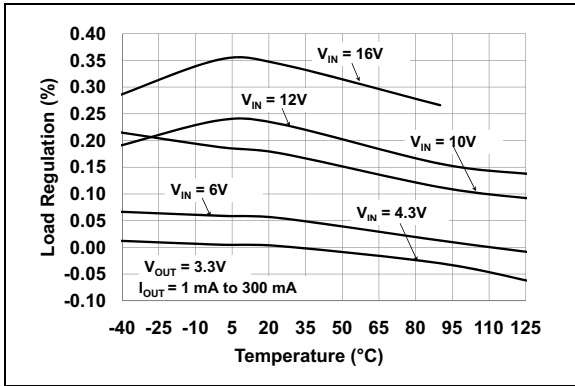
**FIGURE 2-15:** Dynamic Line Response.



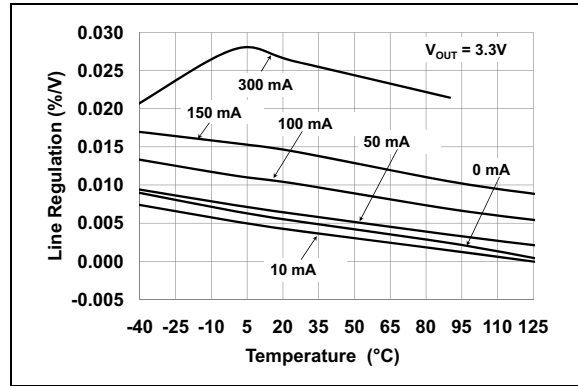
**FIGURE 2-18:** Load Regulation vs. Temperature.

# MCP1755/1755S

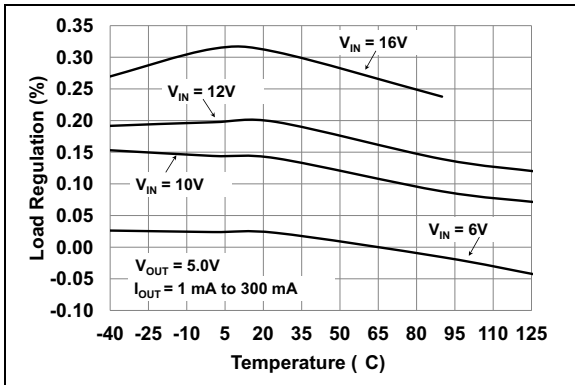
**Note 1:** Unless otherwise indicated  $V_R = 3.3V$ ,  $C_{OUT} = 1 \mu F$  Ceramic (X7R),  $C_{IN} = 1 \mu F$  Ceramic (X7R),  $I_L = 1 mA$ ,  $T_A = +25^\circ C$ ,  $V_{IN} = V_R + 1V$  or  $V_{IN} = 3.6V$  (whichever is greater),  $SHDN = V_{IN}$ , package = SOT-223



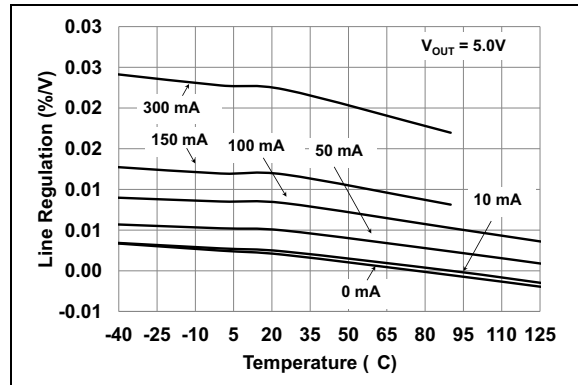
**FIGURE 2-19:** Load Regulation vs. Temperature.



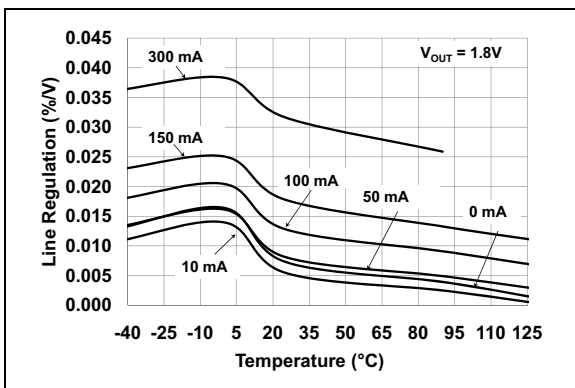
**FIGURE 2-22:** Line Regulation vs. Temperature.



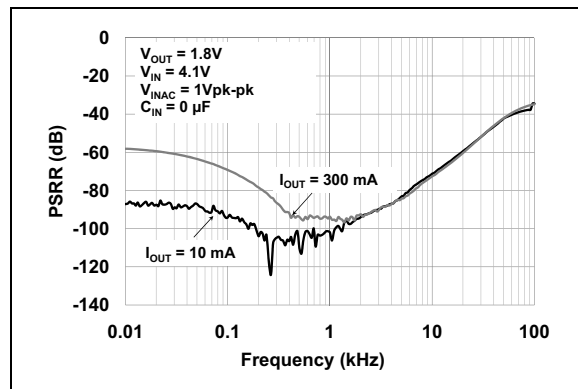
**FIGURE 2-20:** Load Regulation vs. Temperature.



**FIGURE 2-23:** Line Regulation vs. Temperature.

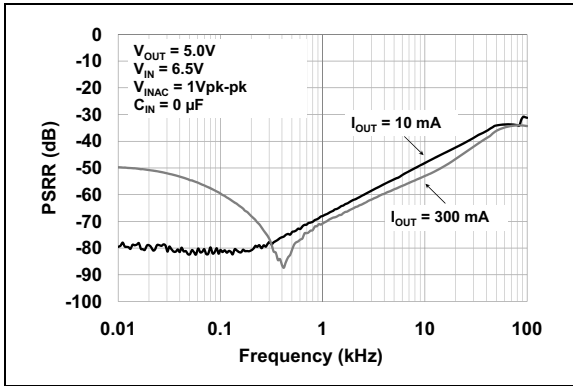


**FIGURE 2-21:** Line Regulation vs. Temperature.

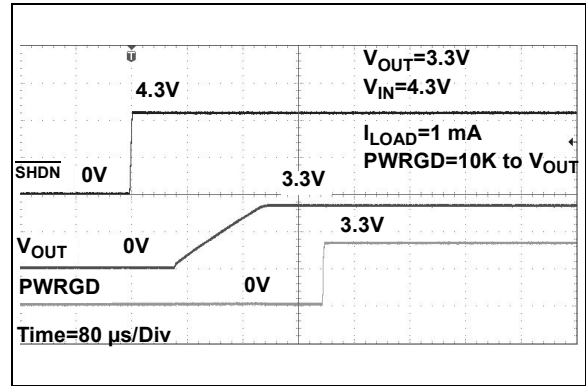


**FIGURE 2-24:** Power Supply Ripple Rejection vs. Frequency.

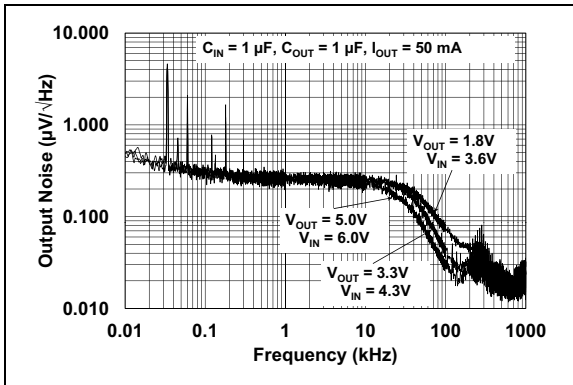
**Note 1:** Unless otherwise indicated  $V_R = 3.3V$ ,  $C_{OUT} = 1 \mu F$  Ceramic (X7R),  $C_{IN} = 1 \mu F$  Ceramic (X7R),  $I_L = 1 mA$ ,  $T_A = +25^\circ C$ ,  $V_{IN} = V_R + 1V$  or  $V_{IN} = 3.6V$  (whichever is greater),  $\overline{SHDN} = V_{IN}$ , package = SOT-223



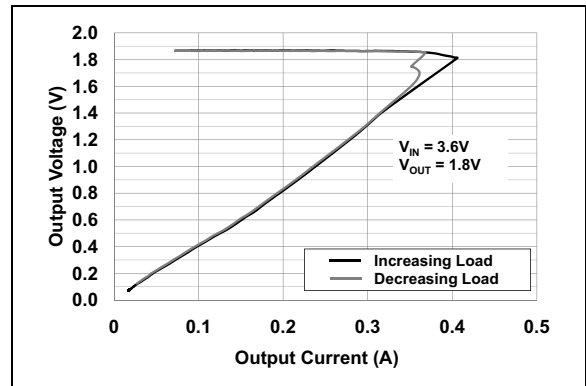
**FIGURE 2-25:** Power Supply Ripple Rejection vs. Frequency.



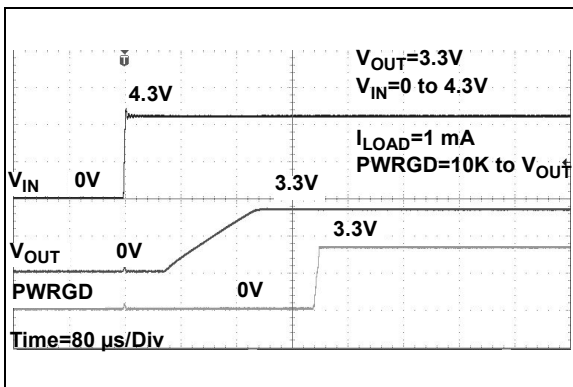
**FIGURE 2-28:** Start-up from  $\overline{SHDN}$ .



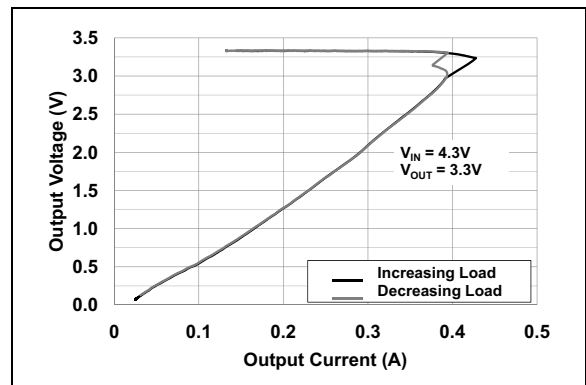
**FIGURE 2-26:** Output Noise vs. Frequency (3 lines,  $V_R = 1.8V, 3.3V, 5.0V$ ).



**FIGURE 2-29:** Short Circuit Current Foldback.



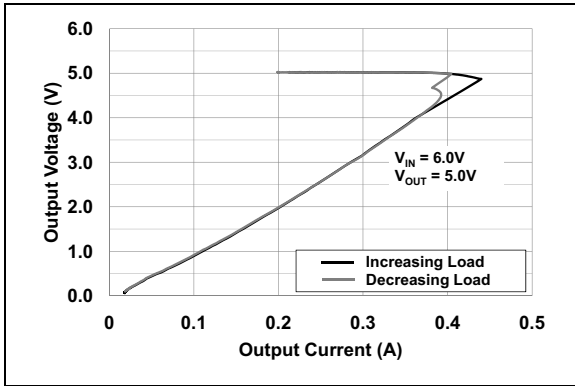
**FIGURE 2-27:** Start-up from  $V_{IN}$ .



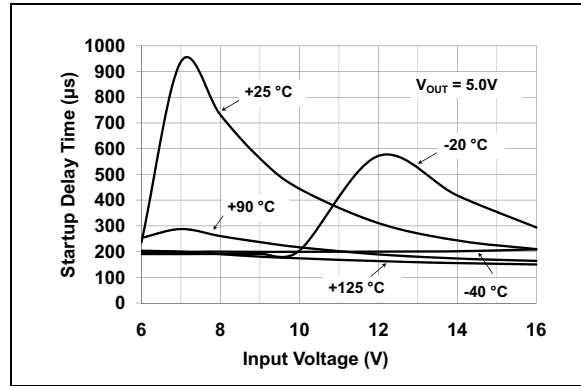
**FIGURE 2-30:** Short Circuit Current Foldback.

# MCP1755/1755S

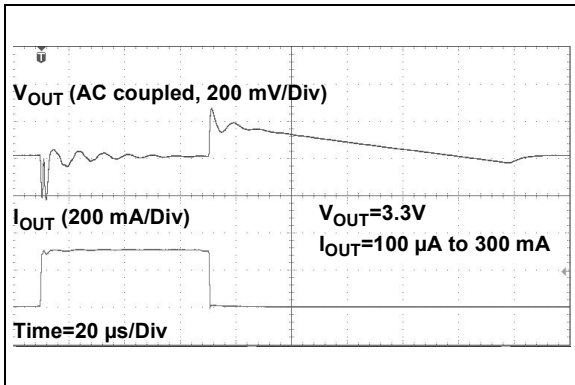
**Note 1:** Unless otherwise indicated  $V_R = 3.3V$ ,  $C_{OUT} = 1 \mu F$  Ceramic (X7R),  $C_{IN} = 1 \mu F$  Ceramic (X7R),  $I_L = 1 mA$ ,  $T_A = +25^\circ C$ ,  $V_{IN} = V_R + 1V$  or  $V_{IN} = 3.6V$  (whichever is greater),  $\overline{SHDN} = V_{IN}$ , package = SOT-223



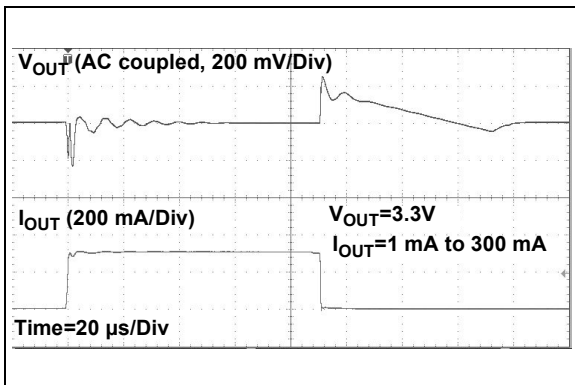
**FIGURE 2-31:** Short Circuit Current Foldback.



**FIGURE 2-34:** Start-up Delay From  $\overline{SHDN}$  to 90%  $V_{OUT}$ .



**FIGURE 2-32:** Dynamic Load Response.



**FIGURE 2-33:** Dynamic Load Response.

## 3.0 PIN DESCRIPTIONS

The descriptions of the pins are listed in [Table 3-1](#) and [Table 3-2](#).

**TABLE 3-1: MCP1755 PIN FUNCTION TABLE**

SOT-223-5	SOT-23-5	2 x 3 DFN	Name	Function
4	5	1	V <sub>OUT</sub>	Regulated Voltage Output
5	4	2	PWRGD	Open Drain Power Good Output
—	—	3, 6, 7	NC	No connection
3	2	4	GND	Ground Terminal
1	3	5	$\overline{\text{SHDN}}$	Shutdown Input
2	1	8	V <sub>IN</sub>	Unregulated Supply Voltage
6	—	9	EP	Exposed Pad, Connected to GND

**TABLE 3-2: MCP1755S PIN FUNCTION TABLE**

SOT-223-3	2 x 3 DFN	Name	Function
3	1	V <sub>OUT</sub>	Regulated Voltage Output
—	2, 3, 5, 6, 7	NC	No connection
2	4	GND	Ground Terminal
1	8	V <sub>IN</sub>	Unregulated Supply Voltage
4	9	EP	Exposed Pad, Connected to GND

### 3.1 Regulated Output Voltage (V<sub>OUT</sub>)

Connect V<sub>OUT</sub> to the positive side of the load and the positive side of the output capacitor. The positive side of the output capacitor should be physically located as close to the LDO V<sub>OUT</sub> pin as is practical. The current flowing out of this pin is equal to the DC load current.

### 3.2 Power Good Output (PWRGD)

The PWRGD output is an open-drain output used to indicate when the LDO output voltage is within 92% (typically) of its nominal regulation value. The PWRGD threshold has a typical hysteresis value of 2%. The PWRGD output is delayed by 100  $\mu$ s (typical) from the time the LDO output is within 92% + 3% (maximum hysteresis) of the regulated output value on power-up. This delay time is internally fixed. The PWRGD pin may be pulled up to V<sub>IN</sub> or V<sub>OUT</sub>. Pulling up to V<sub>OUT</sub> conserves power when the device is in Shutdown ( $\overline{\text{SHDN}} = 0\text{V}$ ) mode.

### 3.3 Ground Terminal (GND)

Regulator ground. Tie GND to the negative side of the output capacitor and also to the negative side of the input capacitor. Only the LDO bias current flows out of this pin; there is no high current. The LDO output regulation is referenced to this pin. Minimize voltage drops between this pin and the negative side of the load.

### 3.4 Shutdown Input ( $\overline{\text{SHDN}}$ )

The  $\overline{\text{SHDN}}$  input is used to turn the LDO output voltage on and off. When the  $\overline{\text{SHDN}}$  input is at a logic-high level, the LDO output voltage is enabled. When the  $\overline{\text{SHDN}}$  input is pulled to a logic-low level, the LDO output voltage is disabled. When the  $\overline{\text{SHDN}}$  input is pulled low, the PWRGD output also goes low and the LDO enters a low quiescent current shutdown state.

# MCP1755/1755S

---

## 3.5 Unregulated Input Voltage ( $V_{IN}$ )

Connect  $V_{IN}$  to the input unregulated source voltage. Like all low dropout linear regulators, low source impedance is necessary for the stable operation of the LDO. The amount of capacitance required to ensure low source impedance will depend on the proximity of the input source capacitors or battery type. For most applications, 1  $\mu$ F of capacitance will ensure stable operation of the LDO circuit. The input capacitor should have a capacitance value equal to or larger than the output capacitor for performance applications. The input capacitor will supply the load current during transients and improve performance. For applications that have load currents below 10 mA, the input capacitance requirement can be lowered. The type of capacitor used may be ceramic, tantalum or aluminum electrolytic. The low ESR characteristics of the ceramic will yield better noise and PSRR performance at high frequency.

## 3.6 Exposed Pad (EP)

Some of the packages have an exposed metal pad on the bottom of the package. The exposed metal pad gives the device better thermal characteristics by providing a good thermal path to either the PCB or heatsink to remove heat from the device. The exposed pad of the package is internally connected to GND.



## 4.0 DEVICE OVERVIEW

The MCP1755/1755S is a 300 mA output current, low-dropout (LDO) voltage regulator. The low-dropout voltage of 300 mV typical at 300 mA of current makes it ideal for battery-powered applications. The input voltage range is 3.6V to 16.0V. Unlike other high output current LDOs, the MCP1755/1755S typically draws only 300  $\mu$ A of quiescent current for a 300 mA load. The MCP1755 adds a shutdown control input pin and a power good output pin. The output voltage options are fixed.

### 4.1 LDO Output Voltage

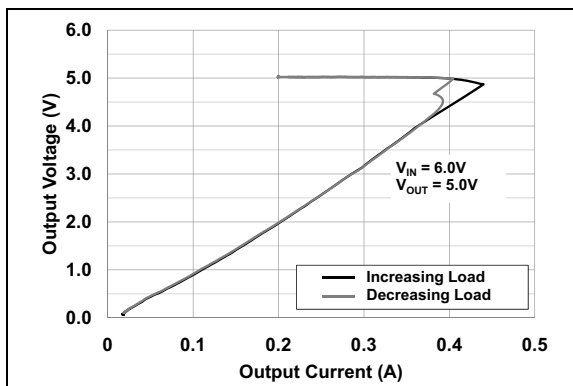
The MCP1755 LDO has a fixed output voltage. The output voltage range is 1.8V to 5.5V. The MCP1755S LDO is available as a fixed voltage device.

### 4.2 Output Current and Current Limiting

The MCP1755/1755S LDO is tested and ensured to supply a minimum of 300 mA of output current. The MCP1755/1755S has no minimum output load, so the output load current can go to 0 mA and the LDO will continue to regulate the output voltage to within tolerance.

The MCP1755/1755S also incorporates a true output current foldback. If the output load presents an excessive load due to a low-impedance short circuit condition, the output current and voltage will fold back towards 30 mA and 0V, respectively. The output voltage and current will resume normal levels when the excessive load is removed. If the overload condition is a soft overload, the MCP1755/1755S will supply higher load currents of up to typically 350 mA. This allows for device usage in applications that have pulsed load currents having an average output current value of 300 mA or less.

Output overload conditions may also result in an overtemperature shutdown of the device. If the junction temperature rises above +150°C (typical), the LDO will shut down the output. See [Section 4.8, Overtemperature Protection](#) for more information on overtemperature shutdown.



**FIGURE 4-1:** Typical Current Foldback.

### 4.3 Output Capacitor

The MCP1755/1755S requires a minimum output capacitance of 1  $\mu$ F for output voltage stability. Ceramic capacitors are recommended because of their size, cost and environmental robustness qualities.

Aluminum-electrolytic and tantalum capacitors can be used on the LDO output as well. The Equivalent Series Resistance (ESR) of the electrolytic output capacitor should be no greater than 2 ohms. The output capacitor should be located as close to the LDO output as is practical. Ceramic materials X7R and X5R have low temperature coefficients and are well within the acceptable ESR range required. A typical 1  $\mu$ F X7R 0805 capacitor has an ESR of 50 milli-ohms.

Larger LDO output capacitors can be used with the MCP1755/1755S to improve dynamic performance and power supply ripple rejection performance. A maximum of 1000  $\mu$ F is recommended. Aluminum-electrolytic capacitors are not recommended for low temperature applications of < -25°C.

### 4.4 Input Capacitor

Low input source impedance is necessary for the LDO output to operate properly. When operating from batteries, or in applications with long lead length (> 10 inches) between the input source and the LDO, some input capacitance is recommended. A minimum of 1.0  $\mu$ F to 4.7  $\mu$ F is recommended for most applications.

For applications that have output step load requirements, the input capacitance of the LDO is very important. The input capacitance provides the LDO with a good local low-impedance source to pull the transient currents from, in order to respond quickly to the output load step. For good step response performance, the input capacitor should be of equivalent or higher value than the output capacitor. The capacitor should be placed as close to the input of the LDO as is practical. Larger input capacitors will also help reduce any high-frequency noise on the input and output of the LDO and reduce the effects of any inductance that exists between the input source voltage and the input capacitance of the LDO.

# MCP1755/1755S

## 4.5 Power Good Output (PWRGD)

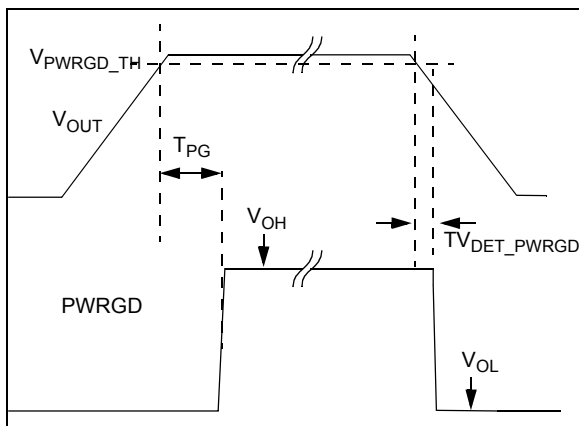
The open drain PWRGD output is used to indicate when the output voltage of the LDO is within 92% (typical value, see [Section 1.0 “Electrical Characteristics”](#) for Minimum and Maximum specifications) of its nominal regulation value.

As the output voltage of the LDO rises, the open-drain PWRGD output will actively be held low until the output voltage has exceeded the power good threshold plus the hysteresis value. Once this threshold has been exceeded, the power good time delay is started (shown as  $T_{PG}$  in the [AC/DC Characteristics](#) table). The power good time delay is fixed at 100  $\mu\text{s}$  (typical). After the time delay period, the PWRGD open-drain output becomes inactive and may be pulled high by an external pullup resistor, indicating that the output voltage is stable and within regulation limits. The power good output is typically pulled up to  $V_{IN}$  or  $V_{OUT}$ . Pulling the signal up to  $V_{OUT}$  conserves power during Shutdown mode.

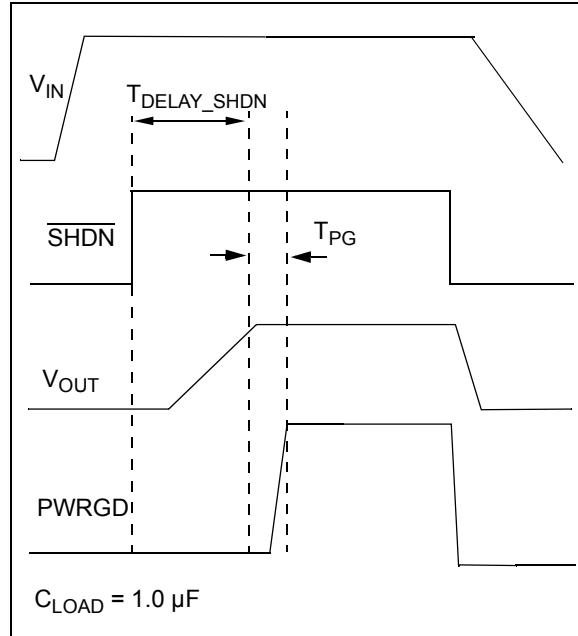
If the output voltage of the LDO falls below the power good threshold, the power good output will transition low. The power good circuitry has a 200  $\mu\text{s}$  delay when detecting a falling output voltage, which helps to increase noise immunity of the power good output and avoid false triggering of the power good output during fast output transients. See [Figure 4-2](#) for power good timing characteristics.

When the LDO is put into Shutdown mode using the  $\overline{\text{SHDN}}$  input, the power good output is pulled low immediately, indicating that the output voltage will be out of regulation. The timing diagram for the power good output when using the shutdown input is shown in [Figure 4-3](#).

The power good output is an open-drain output that can be pulled up to any voltage that is equal to or less than the LDO input voltage. This output is capable of sinking a minimum of 5 mA ( $V_{PWRGD} < 0.45\text{V}$ ).



**FIGURE 4-2:** Power Good Timing.



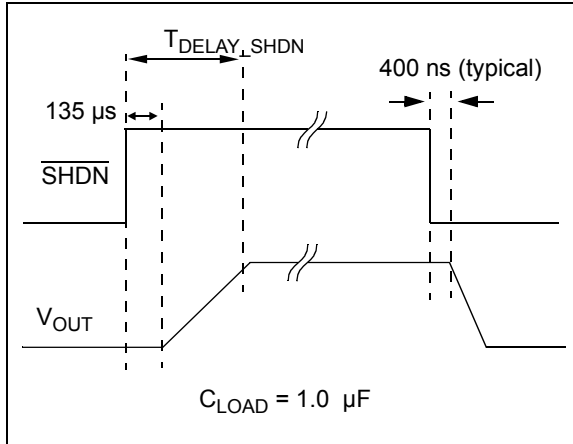
**FIGURE 4-3:** Power Good Timing from Shutdown.

## 4.6 Shutdown Input ( $\overline{\text{SHDN}}$ )

The  $\overline{\text{SHDN}}$  input is an active-low input signal that turns the LDO on and off. The  $\overline{\text{SHDN}}$  threshold is a fixed voltage level. The minimum value of this shutdown threshold required to turn the output ON is 2.4V. The maximum value required to turn the output OFF is 0.8V.

The  $\overline{\text{SHDN}}$  input will ignore low-going pulses (pulses meant to shut down the LDO) that are up to 400 ns in pulse width. If the shutdown input is pulled low for more than 400 ns, the LDO will enter Shutdown mode. This small bit of filtering helps to reject any system noise spikes on the shutdown input signal.

On the rising edge of the  $\overline{\text{SHDN}}$  input, the shutdown circuitry has a 135  $\mu\text{s}$  delay before allowing the LDO output to turn on. This delay helps to reject any false turn-on signals or noise on the  $\overline{\text{SHDN}}$  input signal. After the 135  $\mu\text{s}$  delay, the LDO output enters its soft-start period as it rises from 0V to its final regulation value. If the  $\overline{\text{SHDN}}$  input signal is pulled low during the 135  $\mu\text{s}$  delay period, the timer will be reset and the delay time will start over again on the next rising edge of the  $\overline{\text{SHDN}}$  input. The total time from the  $\overline{\text{SHDN}}$  input going high (turn-on) to the LDO output being in regulation is typically 235  $\mu\text{s}$ . See [Figure 4-4](#) for a timing diagram of the  $\overline{\text{SHDN}}$  input.



**FIGURE 4-4:** Shutdown Input Timing Diagram.

## 4.7 Dropout Voltage and Undervoltage Lockout

Dropout voltage is defined as the input-to-output voltage differential at which the output voltage drops 2% below the nominal value that was measured with a  $V_R + 1.0V$  differential applied. The MCP1755/1755S LDO has a very low dropout voltage specification of 300 mV (typical) at 300 mA of output current. See [Section 1.0 “Electrical Characteristics”](#) for maximum dropout voltage specifications.

The MCP1755/1755S LDO operates across an input voltage range of 3.6V to 16.0V and incorporates input undervoltage lockout (UVLO) circuitry that keeps the LDO output voltage off until the input voltage reaches a minimum of 3.00V (typical) on the rising edge of the input voltage. As the input voltage falls, the LDO output will remain on until the input voltage level reaches 2.70V (typical).

For high-current applications, voltage drops across the PCB traces must be taken into account. The trace resistances can cause significant voltage drops between the input voltage source and the LDO. For applications with input voltages near 3.0V, these PCB trace voltage drops can sometimes lower the input voltage enough to trigger a shutdown due to undervoltage lockout.

## 4.8 Overtemperature Protection

The MCP1755/1755S LDO has temperature-sensing circuitry to prevent the junction temperature from exceeding approximately +150°C. If the LDO junction temperature does reach +150°C, the LDO output will be turned off until the junction temperature cools to approximately +140°C, at which point the LDO output will automatically resume normal operation. If the internal power dissipation continues to be excessive, the device will again shut off. The junction temperature of the die is a function of power dissipation, ambient temperature and package thermal resistance. See [Section 5.0 “Application Circuits and Issues”](#) for more information on LDO power dissipation and junction temperature.

# MCP1755/1755S

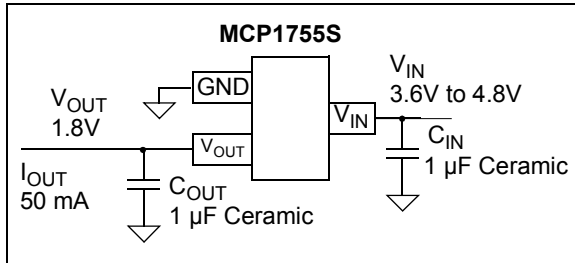
---

NOTES:

## 5.0 APPLICATION CIRCUITS AND ISSUES

### 5.1 Typical Application

The MCP1755/1755S is most commonly used as a voltage regulator. The low quiescent current and low dropout voltage make it ideal for many battery-powered applications.



**FIGURE 5-1:** Typical Application Circuit.

#### 5.1.1 APPLICATION INPUT CONDITIONS

Package Type = SOT-23

Input Voltage Range = 3.6V to 4.8V

$V_{IN}$  maximum = 4.8V

$V_{OUT}$  typical = 1.8V

$I_{OUT}$  = 50 mA maximum

## 5.2 Power Calculations

### 5.2.1 POWER DISSIPATION

The internal power dissipation of the MCP1755/1755S is a function of input voltage, output voltage and output current. The power dissipation, as a result of the quiescent current draw, is so low, it is insignificant ( $68.0 \mu A \times V_{IN}$ ). The following equation can be used to calculate the internal power dissipation of the LDO.

#### EQUATION 5-1:

$$P_{LDO} = (V_{IN(MAX)} - V_{OUT(MIN)}) \times I_{OUT(MAX)}$$

$P_{LDO}$  = LDO Pass device internal power dissipation

$V_{IN(MAX)}$  = Maximum input voltage

$V_{OUT(MIN)}$  = LDO minimum output voltage

The maximum continuous operating junction temperature specified for the MCP1755/1755S is +150°C. To estimate the internal junction temperature of the MCP1755/1755S, the total internal power dissipation is multiplied by the thermal resistance from junction to ambient ( $R\theta_{JA}$ ). The thermal resistance from junction to ambient for the SOT-23 package is estimated at 336°C/W.

#### EQUATION 5-2:

$$T_{J(MAX)} = P_{TOTAL} \times R\theta_{JA} + T_{AMAX}$$

$T_{J(MAX)}$  = Maximum continuous junction temperature

$P_{TOTAL}$  = Total device power dissipation

$R\theta_{JA}$  = Thermal resistance from junction to ambient

$T_{AMAX}$  = Maximum ambient temperature

The maximum power dissipation capability for a package can be calculated given the junction-to-ambient thermal resistance and the maximum ambient temperature for the application. The following equation can be used to determine the package maximum internal power dissipation.

#### EQUATION 5-3:

$$P_{D(MAX)} = \frac{(T_{J(MAX)} - T_{A(MAX)})}{R\theta_{JA}}$$

$P_{D(MAX)}$  = Maximum device power dissipation

$T_{J(MAX)}$  = Maximum continuous junction temperature

$T_{A(MAX)}$  = Maximum ambient temperature

$R\theta_{JA}$  = Thermal resistance from junction to ambient

#### EQUATION 5-4:

$$T_{J(RISE)} = P_{D(MAX)} \times R\theta_{JA}$$

$T_{J(RISE)}$  = Rise in device junction temperature over the ambient temperature

$P_{D(MAX)}$  = Maximum device power dissipation

$R\theta_{JA}$  = Thermal resistance from junction to ambient

#### EQUATION 5-5:

$$T_J = T_{J(RISE)} + T_A$$

$T_J$  = Junction temperature

$T_{J(RISE)}$  = Rise in device junction temperature over the ambient temperature

$T_A$  = Ambient temperature

# MCP1755/1755S

## 5.3 Voltage Regulator

Internal power dissipation, junction temperature rise, junction temperature and maximum power dissipation are calculated in the following example. The power dissipation, as a result of ground current, is small enough to be neglected.

### EXAMPLE 5-1: POWER DISSIPATION

<b>Package</b>
Package Type = SOT-23
<b>Input Voltage</b>
$V_{IN} = 3.6V \text{ to } 4.8V$
<b>LDO Output Voltages and Currents</b>
$V_{OUT} = 1.8V$
$I_{OUT} = 50 \text{ mA}$
<b>Maximum Ambient Temperature</b>
$T_{A(MAX)} = +40^{\circ}C$
<b>Internal Power Dissipation</b>
Internal Power dissipation is the product of the LDO output current times the voltage across the LDO ( $V_{IN}$ to $V_{OUT}$ ).
$P_{LDO(MAX)} = (V_{IN(MAX)} - V_{OUT(MIN)}) \times I_{OUT(MAX)}$
$P_{LDO} = (4.8V - (0.97 \times 1.8V)) \times 50 \text{ mA}$
$P_{LDO} = 152.7 \text{ mW}$

### 5.3.1 DEVICE JUNCTION TEMPERATURE RISE

The internal junction temperature rise is a function of internal power dissipation and the thermal resistance from junction to ambient for the application. The thermal resistance from junction to ambient ( $R_{\theta JA}$ ) is derived from an EIA/JEDEC standard for measuring thermal resistance for small surface mount packages. The EIA/JEDEC specification is JESD51-7, "High Effective Thermal Conductivity Test Board for Leaded Surface Mount Packages". The standard describes the test method and board specifications for measuring the thermal resistance from junction to ambient. The actual thermal resistance for a particular application can vary depending on many factors, such as copper area and thickness. Refer to AN792, "A Method to Determine How Much Power a SOT-23 Can Dissipate in an Application" (DS00792), for more information regarding this subject.

### EXAMPLE 5-2:

$T_{J(RISE)} = P_{TOTAL} \times R_{\theta JA}$
$T_{JRISE} = 152.7 \text{ mW} \times 336.0^{\circ}C/Watt$
$T_{JRISE} = 51.3^{\circ}C$

### 5.3.2 JUNCTION TEMPERATURE ESTIMATE

To estimate the internal junction temperature, the calculated temperature rise is added to the ambient or offset temperature. For this example, the worst-case junction temperature is estimated below.

### EXAMPLE 5-3:

$T_J = T_{JRISE} + T_{A(MAX)}$
$T_J = 91.3^{\circ}C$

### Maximum Package Power Dissipation Examples at +40°C Ambient Temperature

SOT-23 ( $336.0^{\circ}C/Watt = R_{\theta JA}$ )
$P_{D(MAX)} = (125^{\circ}C - 40^{\circ}C)/336^{\circ}C/W$
$P_{D(MAX)} = 253 \text{ mW}$
SOT-89 ( $153.3^{\circ}C/Watt = R_{\theta JA}$ )
$P_{D(MAX)} = (125^{\circ}C - 40^{\circ}C)/153.3^{\circ}C/W$
$P_{D(MAX)} = 554 \text{ mW}$

## 5.4 Voltage Reference

The MCP1755/1755S can be used not only as a regulator, but also as a low quiescent current voltage reference. In many microcontroller applications, the initial accuracy of the reference can be calibrated using production test equipment or by using a ratio measurement. When the initial accuracy is calibrated, the thermal stability and line regulation tolerance are the only errors introduced by the MCP1755/1755S LDO. The low-cost, low quiescent current and small ceramic output capacitor are all advantages when using the MCP1755/1755S as a voltage reference.

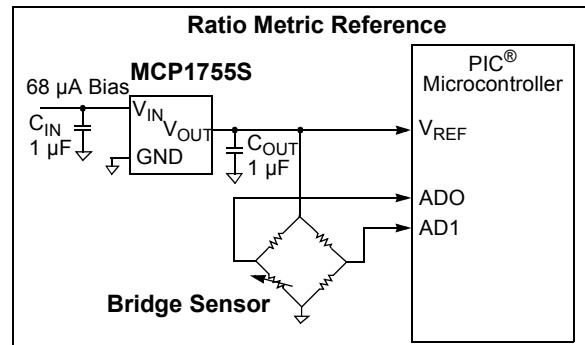


FIGURE 5-2: Using the MCP1755/1755S as a Voltage Reference.

## 5.5 Pulsed Load Applications

For some applications, there are pulsed load current events that may exceed the specified 300 mA maximum specification of the MCP1755/1755S. The internal current limit of the MCP1755/1755S will prevent high peak load demands from causing non-recoverable damage. The 300 mA rating is a maximum average continuous rating. As long as the average current does not exceed 300 mA, higher pulsed load currents can be applied to the MCP1755/1755S. The typical foldback current limit for the MCP1755/1755S is 350 mA ( $T_A = +25^\circ\text{C}$ ).

# MCP1755/1755S

---

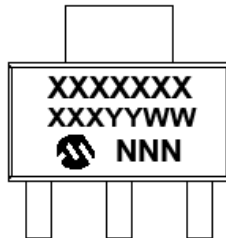
NOTES:



## 6.0 PACKAGING INFORMATION

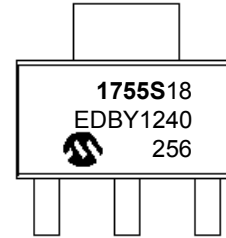
### 6.1 Package Marking Information

#### 3-Lead SOT-223 (MCP1755S only)

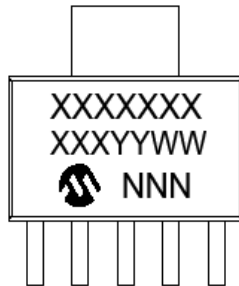


Part Number	First Line Code
MCP1755S-1802E/DB	1755S18
MCP1755ST-1802E/DB	1755S18
MCP1755S-3302E/DB	1755S33
MCP1755ST-3302E/DB	1755S33
MCP1755S-5002E/DB	1755S50
MCP1755ST-5002E/DB	1755S50

Example:

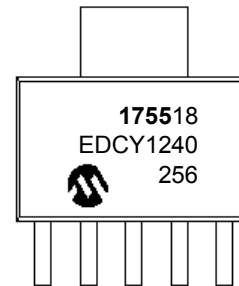


#### 5-Lead SOT-223 (MCP1755 only)

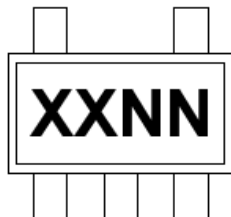


Part Number	First Line Code
MCP1755T-1802E/DC	175518
MCP1755T-3302E/DC	175533
MCP1755T-5002E/DC	175550

Example:

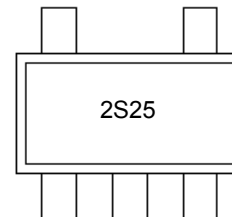


#### 5-Lead SOT-23 (MCP1755 only)



Part Number	Code
MCP1755T-1802E/OT	2SNN
MCP1755T-3302E/OT	3CNN
MCP1755T-5002E/OT	3DNN

Example:



<b>Legend:</b>	XX...X	Customer-specific information
	Y	Year code (last digit of calendar year)
	YY	Year code (last 2 digits of calendar year)
	WW	Week code (week of January 1 is week '01')
	NNN	Alphanumeric traceability code
	(e3)	Pb-free JEDEC designator for Matte Tin (Sn)
	*	This package is Pb-free. The Pb-free JEDEC designator (e3) can be found on the outer packaging for this package.

**Note:** In the event the full Microchip part number cannot be marked on one line, it will be carried over to the next line, thus limiting the number of available characters for customer-specific information.

# MCP1755/1755S

---

## Package Marking Information (Continued)

8-Lead DFN (2x3)



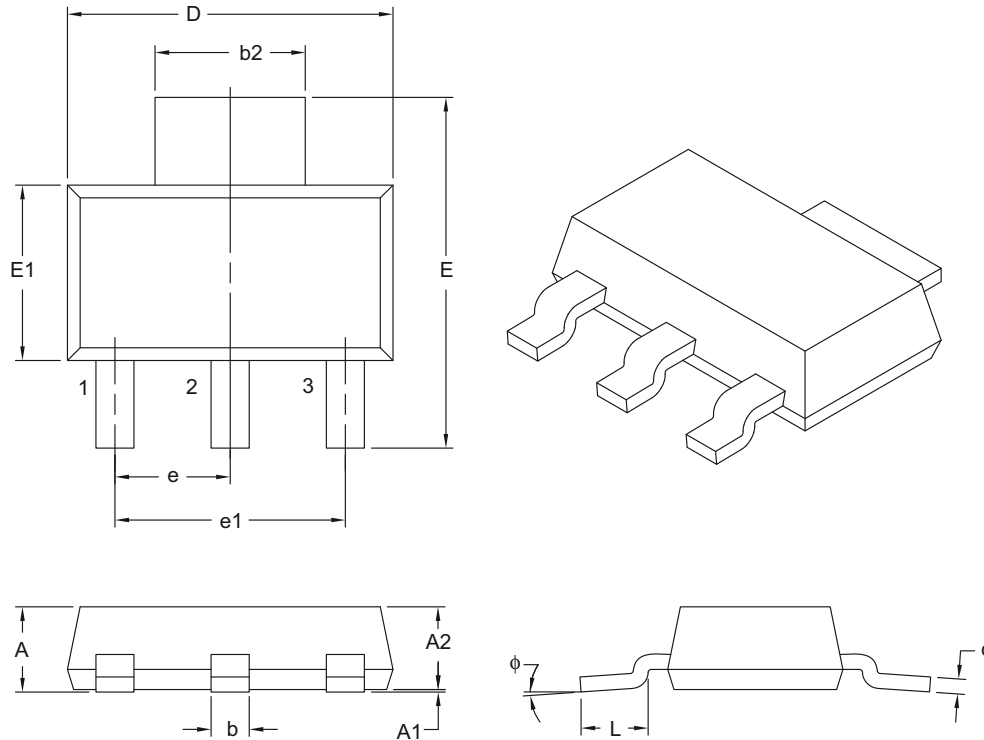
Part Number	First Line Code
MCP1755-1802E/MC	ALZ
MCP1755T-1802E/MC	ALZ
MCP1755-3302E/MC	AKA
MCP1755T-3302E/MC	AKA
MCP1755-5002E/MC	AKB
MCP1755T-5002E/MC	AKB
MCP1755S-1802E/MC	AMA
MCP1755ST-1802E/MC	AMA
MCP1755S-3302E/MC	AMB
MCP1755ST-3302E/MC	AMB
MCP1755S-5002E/MC	AMC
MCP1755ST-5002E/MC	AMC

Example:



## 3-Lead Plastic Small Outline Transistor (DB) [SOT-223]

**Note:** For the most current package drawings, please see the Microchip Packaging Specification located at <http://www.microchip.com/packaging>



Dimension Limits	Units	MILLIMETERS		
		MIN	NOM	MAX
Number of Leads	N	3		
Lead Pitch	e	2.30 BSC		
Outside Lead Pitch	e1	4.60 BSC		
Overall Height	A	–	–	1.80
Standoff	A1	0.02	–	0.10
Molded Package Height	A2	1.50	1.60	1.70
Overall Width	E	6.70	7.00	7.30
Molded Package Width	E1	3.30	3.50	3.70
Overall Length	D	6.30	6.50	6.70
Lead Thickness	c	0.23	0.30	0.35
Lead Width	b	0.60	0.76	0.84
Tab Lead Width	b2	2.90	3.00	3.10
Foot Length	L	0.75	–	–
Lead Angle	$\phi$	0°	–	10°

**Notes:**

- Dimensions D and E1 do not include mold flash or protrusions. Mold flash or protrusions shall not exceed 0.127 mm per side.
- Dimensioning and tolerancing per ASME Y14.5M.

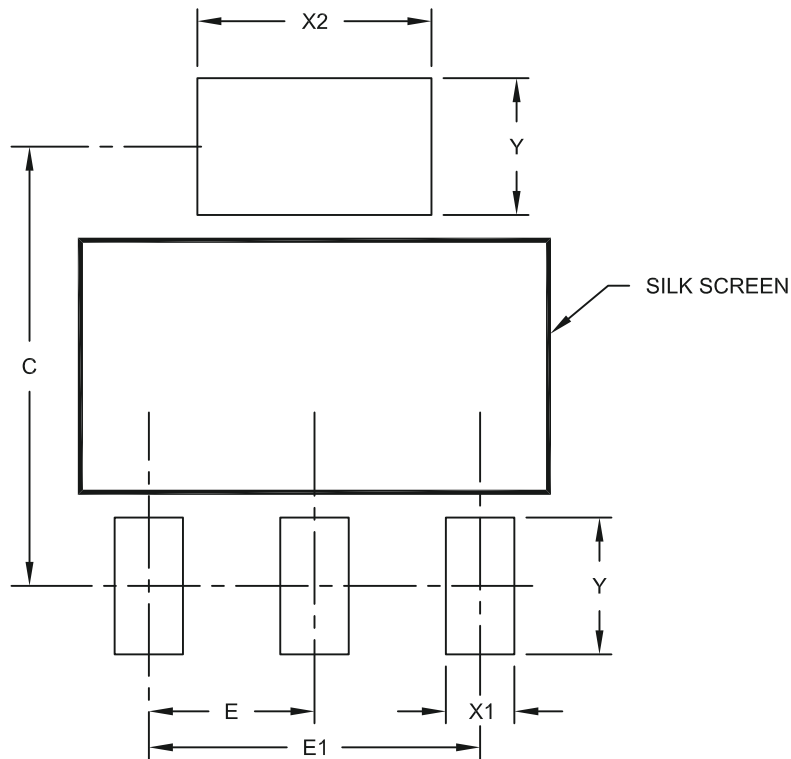
BSC: Basic Dimension. Theoretically exact value shown without tolerances.

Microchip Technology Drawing C04-032B

# MCP1755/1755S

## 3-Lead Plastic Small Outline Transistor (DB) [SOT-223]

**Note:** For the most current package drawings, please see the Microchip Packaging Specification located at <http://www.microchip.com/packaging>



RECOMMENDED LAND PATTERN

Dimension Limits	Units	MILLIMETERS		
		MIN	NOM	MAX
Contact Pitch	E	2.30 BSC		
Overall Pitch	E1	4.60 BSC		
Contact Pad Spacing	C		6.10	
Contact Pad Width	X1			0.95
Contact Pad Width	X2			3.25
Contact Pad Length	Y			1.90

**Notes:**

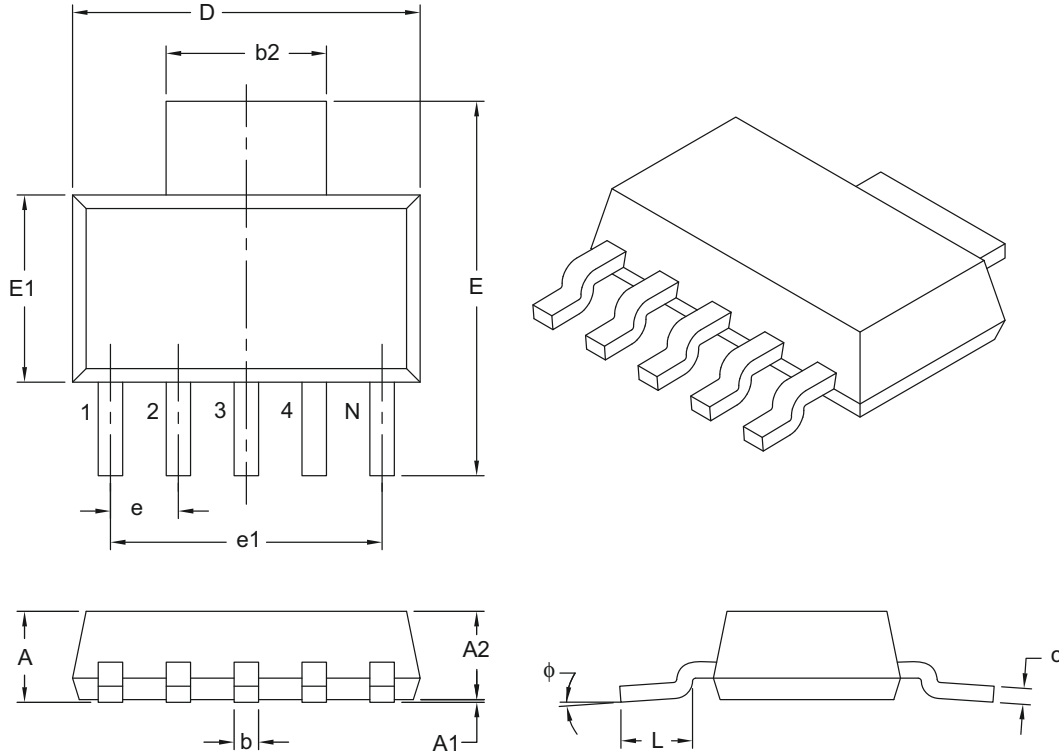
1. Dimensioning and tolerancing per ASME Y14.5M

BSC: Basic Dimension. Theoretically exact value shown without tolerances.

Microchip Technology Drawing No. C04-2032A

## 5-Lead Plastic Small Outline Transistor (DC) [SOT-223]

**Note:** For the most current package drawings, please see the Microchip Packaging Specification located at <http://www.microchip.com/packaging>



Dimension Limits	Units	MILLIMETERS		
		MIN	NOM	MAX
Number of Leads	N	5		
Lead Pitch	e	1.27 BSC		
Outside Lead Pitch	e1	5.08 BSC		
Overall Height	A	–	–	1.80
Standoff	A1	0.02	0.06	0.10
Molded Package Height	A2	1.55	1.60	1.65
Overall Width	E	6.86	7.00	7.26
Molded Package Width	E1	3.45	3.50	3.55
Overall Length	D	6.45	6.50	6.55
Lead Thickness	c	0.24	0.28	0.32
Lead Width	b	0.41	0.457	0.51
Tab Lead Width	b2	2.95	3.00	3.05
Foot Length	L	0.91	–	1.14
Lead Angle	$\phi$	0°	4°	8°

**Notes:**

- Dimensions D and E1 do not include mold flash or protrusions. Mold flash or protrusions shall not exceed 0.127 mm per side.
- Dimensioning and tolerancing per ASME Y14.5M.

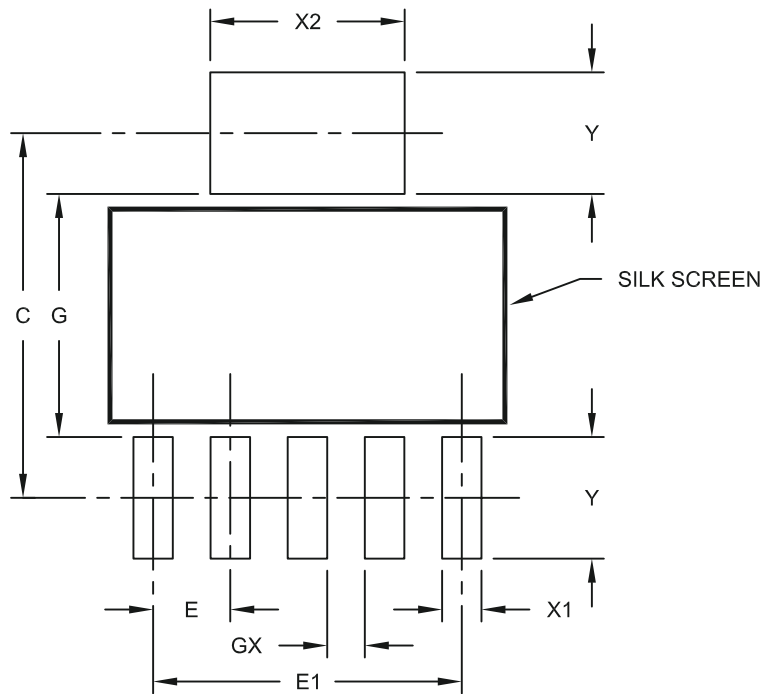
BSC: Basic Dimension. Theoretically exact value shown without tolerances.

Microchip Technology Drawing C04-137B

# MCP1755/1755S

## 5-Lead Plastic Small Outline Transistor (DC) [SOT-223]

**Note:** For the most current package drawings, please see the Microchip Packaging Specification located at <http://www.microchip.com/packaging>



RECOMMENDED LAND PATTERN

Dimension Limits	Units	MILLIMETERS		
		MIN	NOM	MAX
Pad Pitch	E	1.27 BSC		
Overall Pad Pitch	E1	5.08 BSC		
Pad Spacing	C		6.00	
Pad Width	X1			0.65
Pad Width	X2			3.20
Pad Length	Y			2.00
Distance Between Pads	G	4.00		
Distance Between Pads	GX	0.62		

Notes:

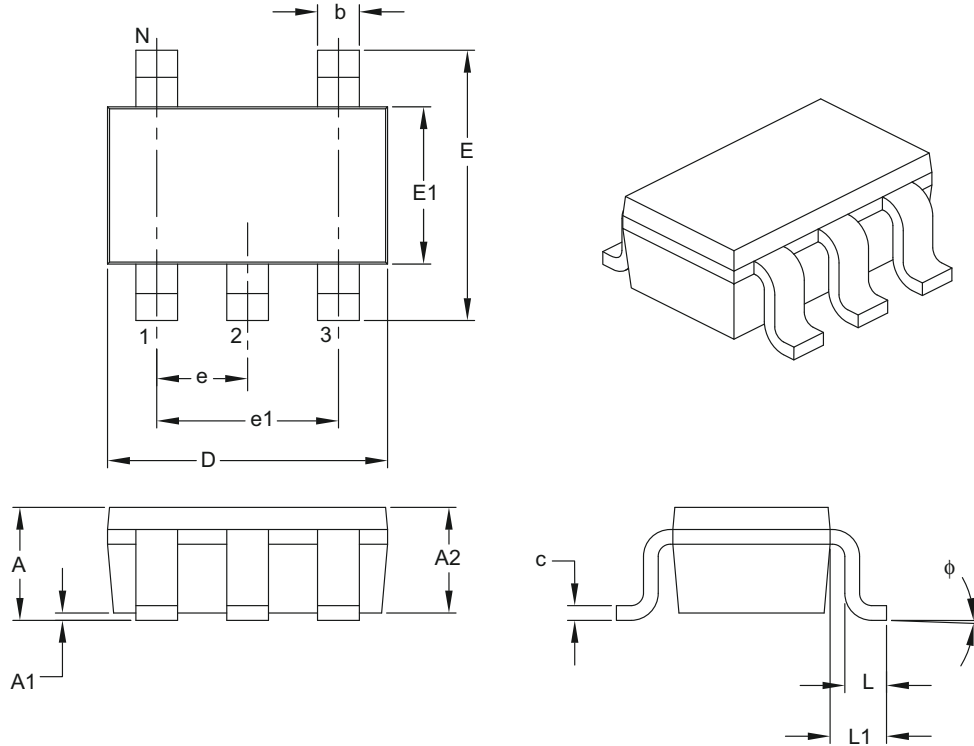
1. Dimensioning and tolerancing per ASME Y14.5M

BSC: Basic Dimension. Theoretically exact value shown without tolerances.

Microchip Technology Drawing No. C04-2137A

## 5-Lead Plastic Small Outline Transistor (OT) [SOT-23]

**Note:** For the most current package drawings, please see the Microchip Packaging Specification located at <http://www.microchip.com/packaging>



Dimension Limits	Units	MILLIMETERS		
		MIN	NOM	MAX
Number of Pins	N	5		
Lead Pitch	e	0.95 BSC		
Outside Lead Pitch	e1	1.90 BSC		
Overall Height	A	0.90	–	1.45
Molded Package Thickness	A2	0.89	–	1.30
Standoff	A1	0.00	–	0.15
Overall Width	E	2.20	–	3.20
Molded Package Width	E1	1.30	–	1.80
Overall Length	D	2.70	–	3.10
Foot Length	L	0.10	–	0.60
Footprint	L1	0.35	–	0.80
Foot Angle	$\phi$	0°	–	30°
Lead Thickness	c	0.08	–	0.26
Lead Width	b	0.20	–	0.51

**Notes:**

- Dimensions D and E1 do not include mold flash or protrusions. Mold flash or protrusions shall not exceed 0.127 mm per side.
- Dimensioning and tolerancing per ASME Y14.5M.

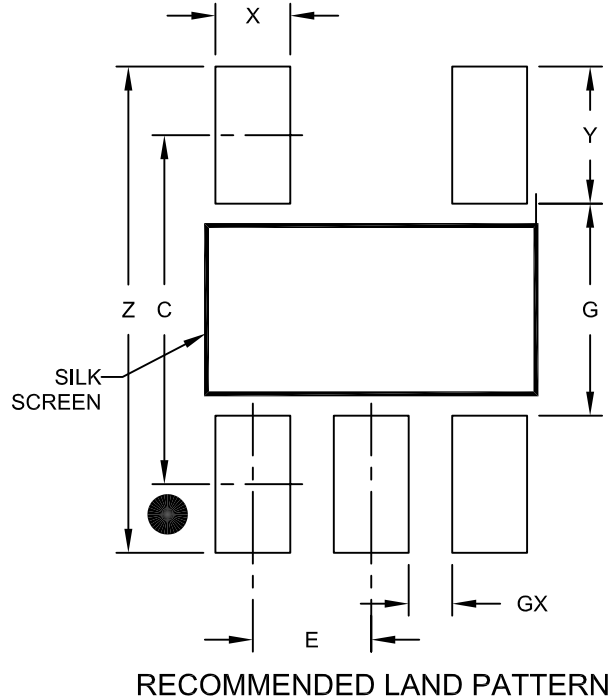
BSC: Basic Dimension. Theoretically exact value shown without tolerances.

Microchip Technology Drawing C04-091B

# MCP1755/1755S

## 5-Lead Plastic Small Outline Transistor (OT) [SOT-23]

**Note:** For the most current package drawings, please see the Microchip Packaging Specification located at <http://www.microchip.com/packaging>



Dimension Limits	Units	MILLIMETERS		
		MIN	NOM	MAX
Contact Pitch	E	0.95 BSC		
Contact Pad Spacing	C		2.80	
Contact Pad Width (X5)	X			0.60
Contact Pad Length (X5)	Y			1.10
Distance Between Pads	G	1.70		
Distance Between Pads	GX	0.35		
Overall Width	Z			3.90

**Notes:**

1. Dimensioning and tolerancing per ASME Y14.5M

BSC: Basic Dimension. Theoretically exact value shown without tolerances.

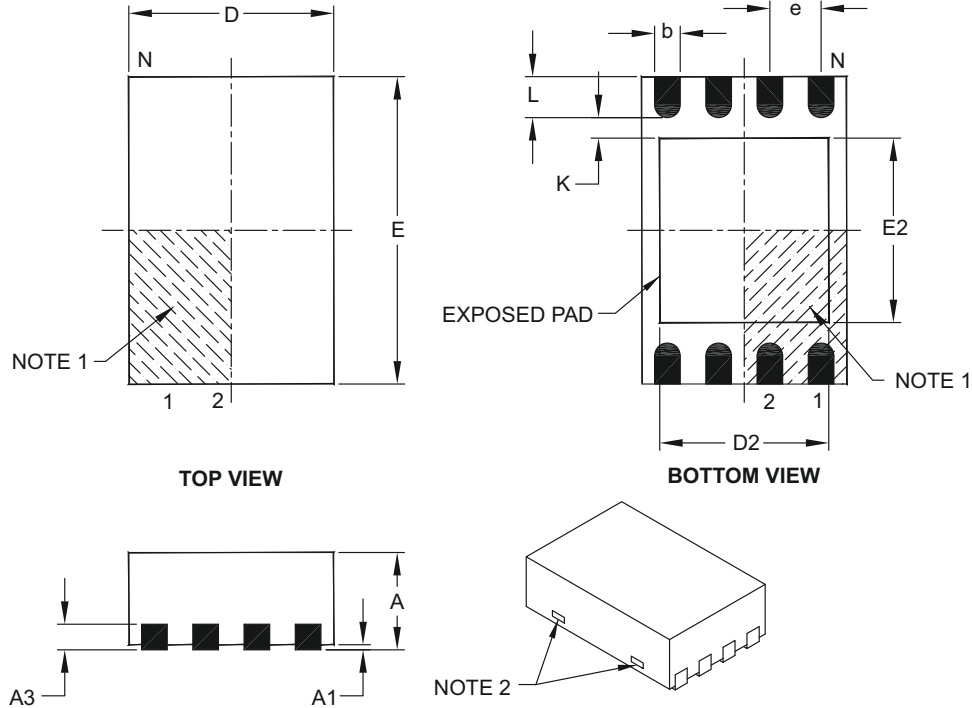
Microchip Technology Drawing No. C04-2091A



# MCP1755/1755S

## 8-Lead Plastic Dual Flat, No Lead Package (MC) – 2x3x0.9 mm Body [DFN]

**Note:** For the most current package drawings, please see the Microchip Packaging Specification located at <http://www.microchip.com/packaging>



Dimension Limits	Units	MILLIMETERS		
		MIN	NOM	MAX
Number of Pins	N	8		
Pitch	e	0.50 BSC		
Overall Height	A	0.80	0.90	1.00
Standoff	A1	0.00	0.02	0.05
Contact Thickness	A3	0.20 REF		
Overall Length	D	2.00 BSC		
Overall Width	E	3.00 BSC		
Exposed Pad Length	D2	1.30	–	1.55
Exposed Pad Width	E2	1.50	–	1.75
Contact Width	b	0.20	0.25	0.30
Contact Length	L	0.30	0.40	0.50
Contact-to-Exposed Pad	K	0.20	–	–

**Notes:**

- Pin 1 visual index feature may vary, but must be located within the hatched area.
- Package may have one or more exposed tie bars at ends.
- Package is saw singulated.
- Dimensioning and tolerancing per ASME Y14.5M.

BSC: Basic Dimension. Theoretically exact value shown without tolerances.

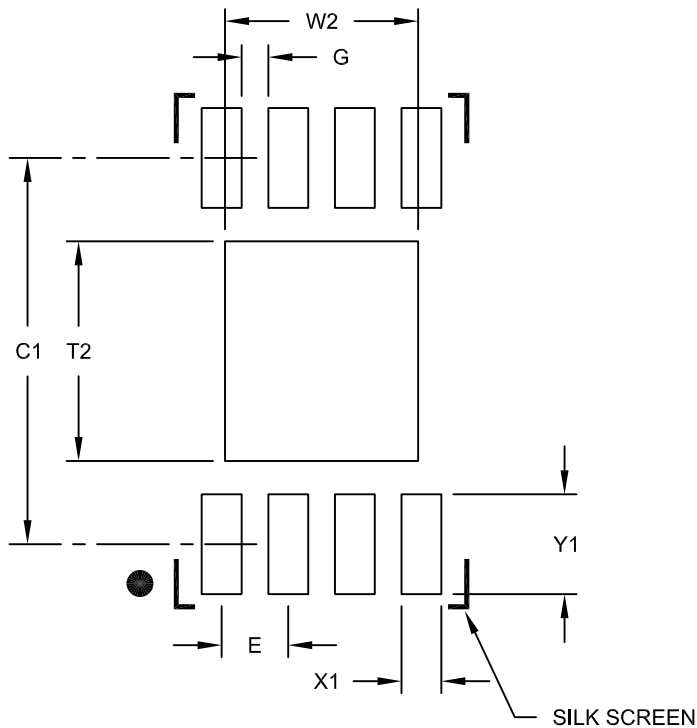
REF: Reference Dimension, usually without tolerance, for information purposes only.

Microchip Technology Drawing C04-123C

# MCP1755/1755S

8-Lead Plastic Dual Flat, No Lead Package (MC) - 2x3x0.9mm Body [DFN]

**Note:** For the most current package drawings, please see the Microchip Packaging Specification located at <http://www.microchip.com/packaging>



RECOMMENDED LAND PATTERN

Dimension Limits	Units	MILLIMETERS		
		MIN	NOM	MAX
Contact Pitch	E	0.50 BSC		
Optional Center Pad Width	W2			1.45
Optional Center Pad Length	T2			1.75
Contact Pad Spacing	C1		2.90	
Contact Pad Width (X8)	X1			0.30
Contact Pad Length (X8)	Y1			0.75
Distance Between Pads	G	0.20		

Notes:

1. Dimensioning and tolerancing per ASME Y14.5M

BSC: Basic Dimension. Theoretically exact value shown without tolerances.

Microchip Technology Drawing No. C04-2123B

## APPENDIX A: REVISION HISTORY

### Revision A (December 2012)

- Original Release of this Document.

# MCP1755/1755S

---

NOTES:

## PRODUCT IDENTIFICATION SYSTEM

To order or obtain information, e.g., on pricing or delivery, refer to the factory or the listed sales office.

<u>PART NO.</u>	<u>X-</u>	<u>XX</u>	<u>X</u>	<u>X</u>	<u>X/</u>	<u>XX</u>
Device	Tape and Reel	Output Voltage	Feature Code	Tolerance	Temp. Range	Package
<b>Device:</b>		MCP1755: 300 mA, 16V, High-Performance LDO MCP1755T: 300 mA, 16V, High-Performance LDO (Tape and Reel) MCP1755S: 300 mA, 16V, High-Performance LDO MCP1755ST: 300 mA, 16V, High-Performance LDO (Tape and Reel)				
<b>Tape and Reel:</b>	T = Tape and Reel					
<b>Output Voltage*:</b>	18 = 1.8V "Standard" 33 = 3.3V "Standard" 50 = 5.0V "Standard"					
	*Contact factory for other voltage options					
<b>Extra Feature Code:</b>	0 = Fixed					
<b>Tolerance:</b>	2 = 2% (Standard)					
<b>Temperature Range:</b>	E = -40°C to +125°C					
<b>Package:</b>	DB = Plastic Small Outline (SOT-223), 3-lead DC = Plastic Small Outline (SOT-223), 5-lead OT = Plastic Small Outline (SOT-23), 5-lead MC = Plastic Dual Flat, No Lead (2x3 DFN), 8-lead					
<b>Examples:</b>						
a) MCP1755ST-1802E/DB: Tape and Reel, 1.8V Output Voltage, Fixed, 2% Tolerance, 3LD SOT-223 Package.						
b) MCP1755ST-3302E/DB: Tape and Reel, 3.3V Output Voltage, Fixed, 2% Tolerance, 3LD SOT-223 Package.						
c) MCP1755ST-5002E/DB: Tape and Reel, 5.0V Output Voltage, Fixed, 2% Tolerance, 3LD SOT-223 Package.						
a) MCP1755T-1802E/DC: Tape and Reel, 1.8V Output Voltage, Fixed, 2% Tolerance, 5LD SOT-223 Package						
b) MCP1755T-3302E/DC: Tape and Reel, 3.3V Output Voltage, Fixed, 2% Tolerance, 5LD SOT-223 Package						
c) MCP1755T-5002E/DC: Tape and Reel, 5.0V Output Voltage, Fixed, 2% Tolerance, 5LD SOT-223 Package						
a) MCP1755T-1802E/OT: Tape and Reel, 1.8V Output Voltage, Fixed, 2% Tolerance, 5LD SOT-23 Package						
b) MCP1755T-3302E/OT: Tape and Reel, 3.3V Output Voltage, Fixed, 2% Tolerance, 5LD SOT-23 Package						
c) MCP1755T-5002E/OT: Tape and Reel, 5.0V Output Voltage, Fixed, 2% Tolerance, 5LD SOT-23 Package						
a) MCP1755T-1802E/MC: Tape and Reel, 1.8V Output Voltage, Fixed, 2% Tolerance, 8LD 2x3 DFN Package						
b) MCP1755T-3302E/MC: Tape and Reel, 3.3V Output Voltage, Fixed, 2% Tolerance, 8LD 2x3 DFN Package						
c) MCP1755T-5002E/MC: Tape and Reel, 5.0V Output Voltage, Fixed, 2% Tolerance, 8LD 2x3 DFN Package						
a) MCP1755ST-1802E/MC: Tape and Reel, 1.8V Output Voltage, Fixed, 2% Tolerance, 8LD 2x3 DFN Package						

# MCP1755/1755S

---

NOTES:

---

---

**Note the following details of the code protection feature on Microchip devices:**

- Microchip products meet the specification contained in their particular Microchip Data Sheet.
- Microchip believes that its family of products is one of the most secure families of its kind on the market today, when used in the intended manner and under normal conditions.
- There are dishonest and possibly illegal methods used to breach the code protection feature. All of these methods, to our knowledge, require using the Microchip products in a manner outside the operating specifications contained in Microchip's Data Sheets. Most likely, the person doing so is engaged in theft of intellectual property.
- Microchip is willing to work with the customer who is concerned about the integrity of their code.
- Neither Microchip nor any other semiconductor manufacturer can guarantee the security of their code. Code protection does not mean that we are guaranteeing the product as “unbreakable.”

Code protection is constantly evolving. We at Microchip are committed to continuously improving the code protection features of our products. Attempts to break Microchip's code protection feature may be a violation of the Digital Millennium Copyright Act. If such acts allow unauthorized access to your software or other copyrighted work, you may have a right to sue for relief under that Act.

---

Information contained in this publication regarding device applications and the like is provided only for your convenience and may be superseded by updates. It is your responsibility to ensure that your application meets with your specifications. MICROCHIP MAKES NO REPRESENTATIONS OR WARRANTIES OF ANY KIND WHETHER EXPRESS OR IMPLIED, WRITTEN OR ORAL, STATUTORY OR OTHERWISE, RELATED TO THE INFORMATION, INCLUDING BUT NOT LIMITED TO ITS CONDITION, QUALITY, PERFORMANCE, MERCHANTABILITY OR FITNESS FOR PURPOSE. Microchip disclaims all liability arising from this information and its use. Use of Microchip devices in life support and/or safety applications is entirely at the buyer's risk, and the buyer agrees to defend, indemnify and hold harmless Microchip from any and all damages, claims, suits, or expenses resulting from such use. No licenses are conveyed, implicitly or otherwise, under any Microchip intellectual property rights.

#### **Trademarks**

The Microchip name and logo, the Microchip logo, dsPIC, FlashFlex, KEELOQ, KEELOQ logo, MPLAB, PIC, PICmicro, PICSTART, PIC<sup>32</sup> logo, rPIC, SST, SST Logo, SuperFlash and UNI/O are registered trademarks of Microchip Technology Incorporated in the U.S.A. and other countries.

FilterLab, Hampshire, HI-TECH C, Linear Active Thermistor, MTP, SEEVAL and The Embedded Control Solutions Company are registered trademarks of Microchip Technology Incorporated in the U.S.A.

Silicon Storage Technology is a registered trademark of Microchip Technology Inc. in other countries.

Analog-for-the-Digital Age, Application Maestro, BodyCom, chipKIT, chipKIT logo, CodeGuard, dsPICDEM, dsPICDEM.net, dsPICworks, dsSPEAK, ECAN, ECONOMONITOR, FanSense, HI-TIDE, In-Circuit Serial Programming, ICSP, Mindi, MiWi, MPASM, MPF, MPLAB Certified logo, MPLIB, MPLINK, mTouch, Omniclient Code Generation, PICC, PICC-18, PICDEM, PICDEM.net, PICkit, PICtail, REAL ICE, rFLAB, Select Mode, SQI, Serial Quad I/O, Total Endurance, TSHARC, UniWinDriver, WiperLock, ZENA and Z-Scale are trademarks of Microchip Technology Incorporated in the U.S.A. and other countries.

SQTP is a service mark of Microchip Technology Incorporated in the U.S.A.

GestIC and ULPP are registered trademarks of Microchip Technology Germany II GmbH & Co. & KG, a subsidiary of Microchip Technology Inc., in other countries.

All other trademarks mentioned herein are property of their respective companies.

© 2012, Microchip Technology Incorporated, Printed in the U.S.A., All Rights Reserved.

 Printed on recycled paper.

ISBN: 9781620768181

**QUALITY MANAGEMENT SYSTEM**  
**CERTIFIED BY DNV**  
**== ISO/TS 16949 ==**

*Microchip received ISO/TS-16949:2009 certification for its worldwide headquarters, design and wafer fabrication facilities in Chandler and Tempe, Arizona; Gresham, Oregon and design centers in California and India. The Company's quality system processes and procedures are for its PIC® MCUs and dsPIC® DSCs, KEELOQ® code hopping devices, Serial EEPROMs, microperipherals, nonvolatile memory and analog products. In addition, Microchip's quality system for the design and manufacture of development systems is ISO 9001:2000 certified.*



# MICROCHIP

## Worldwide Sales and Service

### AMERICAS

**Corporate Office**  
2355 West Chandler Blvd.  
Chandler, AZ 85224-6199  
Tel: 480-792-7200  
Fax: 480-792-7277  
Technical Support:  
<http://www.microchip.com/support>  
Web Address:  
[www.microchip.com](http://www.microchip.com)

**Atlanta**  
Duluth, GA  
Tel: 678-957-9614  
Fax: 678-957-1455

**Boston**  
Westborough, MA  
Tel: 774-760-0087  
Fax: 774-760-0088

**Chicago**  
Itasca, IL  
Tel: 630-285-0071  
Fax: 630-285-0075

**Cleveland**  
Independence, OH  
Tel: 216-447-0464  
Fax: 216-447-0643

**Dallas**  
Addison, TX  
Tel: 972-818-7423  
Fax: 972-818-2924

**Detroit**  
Farmington Hills, MI  
Tel: 248-538-2250  
Fax: 248-538-2260

**Indianapolis**  
Noblesville, IN  
Tel: 317-773-8323  
Fax: 317-773-5453

**Los Angeles**  
Mission Viejo, CA  
Tel: 949-462-9523  
Fax: 949-462-9608

**Santa Clara**  
Santa Clara, CA  
Tel: 408-961-6444  
Fax: 408-961-6445

**Toronto**  
Mississauga, Ontario,  
Canada  
Tel: 905-673-0699  
Fax: 905-673-6509

### ASIA/PACIFIC

**Asia Pacific Office**  
Suites 3707-14, 37th Floor  
Tower 6, The Gateway  
Harbour City, Kowloon  
Hong Kong  
Tel: 852-2401-1200  
Fax: 852-2401-3431

**Australia - Sydney**  
Tel: 61-2-9868-6733  
Fax: 61-2-9868-6755

**China - Beijing**  
Tel: 86-10-8569-7000  
Fax: 86-10-8528-2104

**China - Chengdu**  
Tel: 86-28-8665-5511  
Fax: 86-28-8665-7889

**China - Chongqing**  
Tel: 86-23-8980-9588  
Fax: 86-23-8980-9500

**China - Hangzhou**  
Tel: 86-571-2819-3187  
Fax: 86-571-2819-3189

**China - Hong Kong SAR**  
Tel: 852-2943-5100  
Fax: 852-2401-3431

**China - Nanjing**  
Tel: 86-25-8473-2460  
Fax: 86-25-8473-2470

**China - Qingdao**  
Tel: 86-532-8502-7355  
Fax: 86-532-8502-7205

**China - Shanghai**  
Tel: 86-21-5407-5533  
Fax: 86-21-5407-5066

**China - Shenyang**  
Tel: 86-24-2334-2829  
Fax: 86-24-2334-2393

**China - Shenzhen**  
Tel: 86-755-8864-2200  
Fax: 86-755-8203-1760

**China - Wuhan**  
Tel: 86-27-5980-5300  
Fax: 86-27-5980-5118

**China - Xian**  
Tel: 86-29-8833-7252  
Fax: 86-29-8833-7256

**China - Xiamen**  
Tel: 86-592-2388138  
Fax: 86-592-2388130

**China - Zhuhai**  
Tel: 86-756-3210040  
Fax: 86-756-3210049

### ASIA/PACIFIC

**India - Bangalore**  
Tel: 91-80-3090-4444  
Fax: 91-80-3090-4123

**India - New Delhi**  
Tel: 91-11-4160-8631  
Fax: 91-11-4160-8632

**India - Pune**  
Tel: 91-20-2566-1512  
Fax: 91-20-2566-1513

**Japan - Osaka**  
Tel: 81-6-6152-7160  
Fax: 81-6-6152-9310

**Japan - Tokyo**  
Tel: 81-3-6880-3770  
Fax: 81-3-6880-3771

**Korea - Daegu**  
Tel: 82-53-744-4301  
Fax: 82-53-744-4302

**Korea - Seoul**  
Tel: 82-2-554-7200  
Fax: 82-2-558-5932 or  
82-2-558-5934

**Malaysia - Kuala Lumpur**  
Tel: 60-3-6201-9857  
Fax: 60-3-6201-9859

**Malaysia - Penang**  
Tel: 60-4-227-8870  
Fax: 60-4-227-4068

**Philippines - Manila**  
Tel: 63-2-634-9065  
Fax: 63-2-634-9069

**Singapore**  
Tel: 65-6334-8870  
Fax: 65-6334-8850

**Taiwan - Hsin Chu**  
Tel: 886-3-5778-366  
Fax: 886-3-5770-955

**Taiwan - Kaohsiung**  
Tel: 886-7-213-7828  
Fax: 886-7-330-9305

**Taiwan - Taipei**  
Tel: 886-2-2508-8600  
Fax: 886-2-2508-0102

**Thailand - Bangkok**  
Tel: 66-2-694-1351  
Fax: 66-2-694-1350

### EUROPE

**Austria - Wels**  
Tel: 43-7242-2244-39  
Fax: 43-7242-2244-393

**Denmark - Copenhagen**  
Tel: 45-4450-2828  
Fax: 45-4485-2829

**France - Paris**  
Tel: 33-1-69-53-63-20  
Fax: 33-1-69-30-90-79

**Germany - Munich**  
Tel: 49-89-627-144-0  
Fax: 49-89-627-144-44

**Italy - Milan**  
Tel: 39-0331-742611  
Fax: 39-0331-466781

**Netherlands - Drunen**  
Tel: 31-416-690399  
Fax: 31-416-690340

**Spain - Madrid**  
Tel: 34-91-708-08-90  
Fax: 34-91-708-08-91

**UK - Wokingham**  
Tel: 44-118-921-5869  
Fax: 44-118-921-5820

11/29/12





Компания «ЭлектроПласт» предлагает заключение долгосрочных отношений при поставках импортных электронных компонентов на взаимовыгодных условиях!

Наши преимущества:

- Оперативные поставки широкого спектра электронных компонентов отечественного и импортного производства напрямую от производителей и с крупнейших мировых складов;
- Поставка более 17-ти миллионов наименований электронных компонентов;
- Поставка сложных, дефицитных, либо снятых с производства позиций;
- Оперативные сроки поставки под заказ (от 5 рабочих дней);
- Экспресс доставка в любую точку России;
- Техническая поддержка проекта, помощь в подборе аналогов, поставка прототипов;
- Система менеджмента качества сертифицирована по Международному стандарту ISO 9001;
- Лицензия ФСБ на осуществление работ с использованием сведений, составляющих государственную тайну;
- Поставка специализированных компонентов (Xilinx, Altera, Analog Devices, Intersil, Interpoint, Microsemi, Aeroflex, Peregrine, Syfer, Eurofarad, Texas Instrument, Miteq, Cobham, E2V, MA-COM, Hittite, Mini-Circuits, General Dynamics и др.);

Помимо этого, одним из направлений компании «ЭлектроПласт» является направление «Источники питания». Мы предлагаем Вам помощь Конструкторского отдела:

- Подбор оптимального решения, техническое обоснование при выборе компонента;
- Подбор аналогов;
- Консультации по применению компонента;
- Поставка образцов и прототипов;
- Техническая поддержка проекта;
- Защита от снятия компонента с производства.



#### Как с нами связаться

**Телефон:** 8 (812) 309 58 32 (многоканальный)

**Факс:** 8 (812) 320-02-42

**Электронная почта:** [org@eplast1.ru](mailto:org@eplast1.ru)

**Адрес:** 198099, г. Санкт-Петербург, ул. Калинина, дом 2, корпус 4, литера А.