

Snubberless™, logic level and standard 16 A Triacs

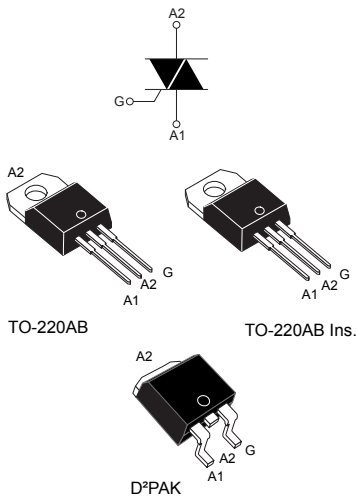

Features

- Medium current Triac
- Low thermal resistance with clip bonding
- Low thermal resistance insulation ceramic for insulated BTA
- High commutation (4Q) or very high commutation (3Q, Snubberless™) capability
- BTA series UL1557 certified (file ref: 81734)
- Packages are RoHS (2002/95/EC) compliant
- Insulated tab (BTA series, rated at 2500 V_{RMS})

Applications

- Snubberless versions (BTA/BTB...W and T1635) especially recommended for use on inductive loads, because of their high commutation performances
- On/off or phase angle function in applications such as static relays, light dimmers and appliance motor speed controllers

Description

Available either in through-hole or surface mount packages, the BTA16, BTB16 and T1610, T1635 and T1650 Triac series are suitable for general purpose mains power AC switching. They can be used as ON/OFF function in applications such as static relays, heating regulation or induction motor starting circuit. They are also recommended for phase control operations in light dimmers and appliance motors speed controllers.

The Snubberless™ versions (W suffix and T1610, T1635, T1650) are especially recommended for use on inductive loads, because of their high commutation performance.

By using an internal ceramic pad, the Snubberless™ series provide an insulated tab (rated at 2500 V_{RMS}) complying with UL standards (file reference: E81734).

Product status link	
	BTA16
	BTB16
	T1610
	T1635
	T1650
Product summary	
I_{T(RMS)}	16 A
V_{DRM}/V_RRM	600, 800 V
I_{GT}Snubberless™	10, 35, 50 mA
I_{GT}standard	25, 50 mA

1 Characteristics

Table 1. Absolute maximum ratings

Symbol	Parameters	Value	Unit	
$I_{T(RMS)}$	RMS on-state current (full sine wave)	TO-220AB, D ² PAK $T_c = 100\text{ °C}$	16	A
		TO-220AB Ins. $T_c = 86\text{ °C}$		
I_{TSM}	Non repetitive surge peak on-state current (full cycle, T_j initial = 25 °C)	F = 50 Hz $t_p = 20\text{ ms}$	160	A
		F = 60 Hz $t_p = 16.7\text{ ms}$	168	
I^2t	I^2t value for fusing	$t_p = 10\text{ ms}$	144	A ² s
di/dt	Critical rate of rise of on-state current $I_G = 2 \times I_{GT}$, $t_r \leq 100\text{ ns}$	F = 120 Hz $T_j = 125\text{ °C}$	50	A/ μ s
V_{DSM}/V_{RSM}	Non repetitive surge peak off-state voltage	$t_p = 10\text{ ms}$ $T_j = 25\text{ °C}$	$V_{DRM}/V_{RRM} + 100$	V
I_{GM}	Peak gate current	$t_p = 20\text{ }\mu$ s $T_j = 125\text{ °C}$	4	A
$P_{G(AV)}$	Average gate power dissipation	$T_j = 125\text{ °C}$	1	W
T_{stg}	Storage junction temperature range		-40 to +150	°C
T_j	Operating junction temperature range		-40 to +125	°C

Table 2. Static electrical characteristics

Symbol	Test conditions	T_j		Value	Unit
$V_T^{(1)}$	$I_{TM} = 22.5\text{ A}$, $t_p = 380\text{ }\mu$ s	25 °C	Max.	1.55	V
$V_{TO}^{(1)}$	threshold on-state voltage	125 °C	Max.	0.85	V
$R_D^{(1)}$	Dynamic resistance	125 °C	Max.	25	m Ω
I_{DRM}/I_{RRM}	$V_{DRM} = V_{RRM}$	25 °C	Max.	5	μ A
		125 °C		2	mA

1. For both polarities of A2 referenced to A1

Table 3. Electrical characteristics ($T_j = 25\text{ °C}$, unless otherwise specified) - standard (4 quadrants)

Symbol	Parameters	Quadrant		BTA16 BTB16		Unit
				C	B	
$I_{GT}^{(1)}$	$V_D = 12\text{ V}$, $R_L = 33\text{ }\Omega$	I - II - III	Max.	25	50	mA
		IV		50	100	
V_{GT}		All	Max.	1.3		V
V_{GD}	$V_D = V_{DRM}$, $R_L = 3.3\text{ k}\Omega$, $T_j = 125\text{ °C}$	All	Min.	0.2		V
$I_H^{(2)}$	$I_T = 500\text{ mA}$		Max.	25	50	mA
I_L	$I_G = 1.2 I_{GT}$	I - III - IV	Max.	40	60	mA
		II	Max.	80	120	

Symbol	Parameters	Quadrant		BTA16 BTB16		Unit
				C	B	
$dV/dt^{(2)}$	$V_D = 67\% V_{DRM}$ gate open, $T_j = 125\text{ °C}$		Min.	200	400	V/ μ s
$(dI/dt)_c^{(2)}$	$(dI/dt)_c = 7\text{ A/ms}$, $T_j = 125\text{ °C}$		Min.	5	10	V/ μ s

1. Minimum I_{GT} is guaranteed at 5 % of I_{GT} max.
2. For both polarities of A2 referenced to A1

Table 4. Electrical characteristics ($T_j = 25\text{ °C}$, unless otherwise specified) - Snubberless and logic level (3 quadrants)

Symbol	Parameters	Quadrant		T1610 / BTA16- SW / BTB16- SW	T1635 / BTA16-CW / BTB16-CW	T1650 / BTA16-BW / BTB16-BW	Unit
$I_{GT}^{(1)}$	$V_D = 12\text{ V}$, $R_L = 30\ \Omega$	I - II - III	Max.	10	35	50	mA
V_{GT}			Max.	1.3			V
V_{GD}	$V_D = V_{DRM}$, $R_L = 3,3\text{ k}\Omega$, $T_j = 125\text{ °C}$		Min.	0.2			V
$I_H^{(2)}$	$I_T = 500\text{ mA}$		Max.	15	35	50	mA
I_L	$I_G = 1.2 I_{GT}$	I - III	Max.	25	50	70	mA
		II	Max.	30	60	80	
$(dV/dt)^{(2)}$	$V_D = 67\% V_{DRM}$ gate open, $T_j = 125\text{ °C}$		Min.	40	500	1000	V/ μ s
$(dI/dt)_c^{(2)}$	$(dV/dt)_c = 0.1\text{ V}/\mu\text{s}$, $T_j = 125\text{ °C}$			8.5			A/ms
	$(dV/dt)_c = 10\text{ V}/\mu\text{s}$, $T_j = 125\text{ °C}$		Min.	3.0			
	Without snubber, $T_j = 125\text{ °C}$				8.5	14	

1. Minimum I_{GT} is guaranteed at 5 % of I_{GT} max.
2. For both polarities of A2 referenced to A1

Table 5. Thermal resistance

Symbol	Parameters	Value	Unit
$R_{th(j-c)}$	Max. junction to case (AC)	TO-220AB / D ² PAK	1.2
		TO-220AB insulated	2.1
$R_{th(j-a)}$	Junction to ambient (S = 2 cm ²)	D ² PAK	45
	Junction to ambient	TO-220AB / TO-220AB ins	60

1. Copper surface under tab.

1.1 Characteristics (curves)

Figure 2. Maximum power dissipation versus on-state RMS current (full cycle)

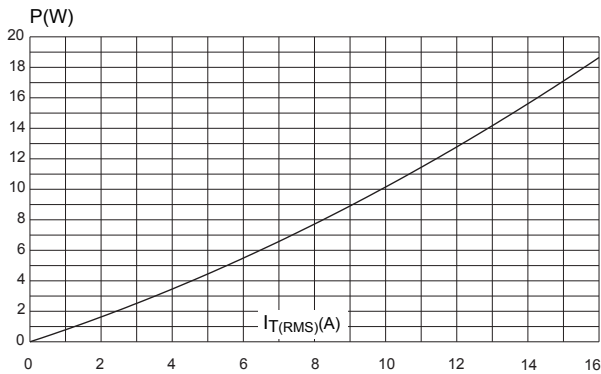

Figure 3. RMS on-state current versus case temperature (full cycle)

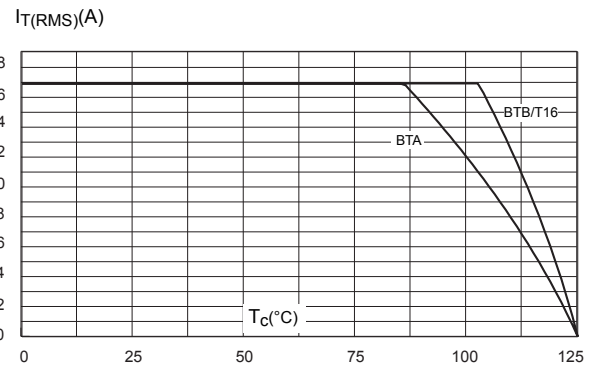

Figure 4. On-state rms current versus ambient temperature (full cycle)

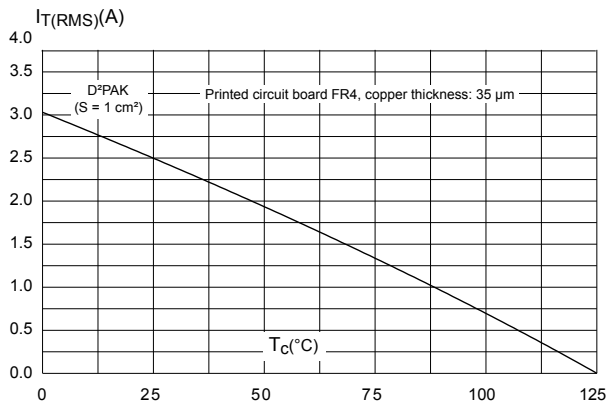

Figure 5. Relative variation of thermal impedance versus pulse duration

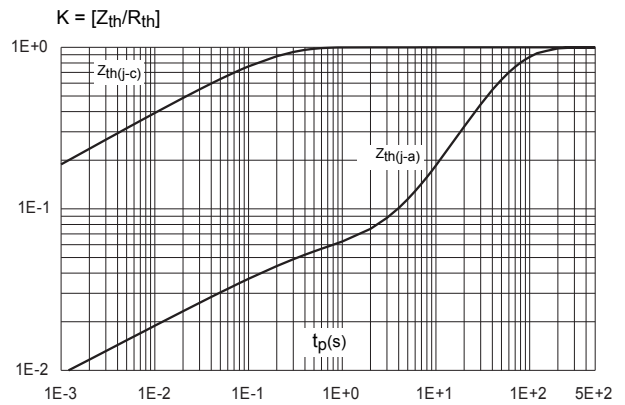

Figure 6. On-state characteristics (maximum values)



Figure 7. Surge peak on-state current versus number of cycles



Figure 8. Non-repetitive surge peak on-state current for a sinusoidal

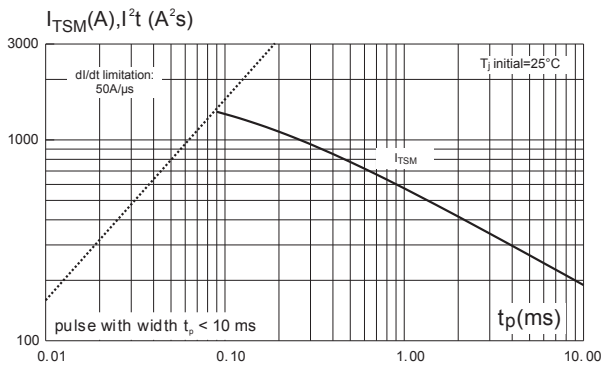

Figure 9. Relative variation of gate trigger current



Figure 10. Relative variation of critical rate of decrease of main current versus (dV/dt)c (typical values)

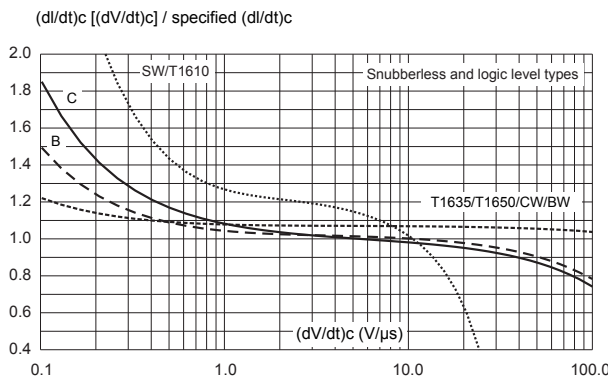

Figure 11. Relative variation of critical rate of decrease of main current versus (junction temperature (typical values)

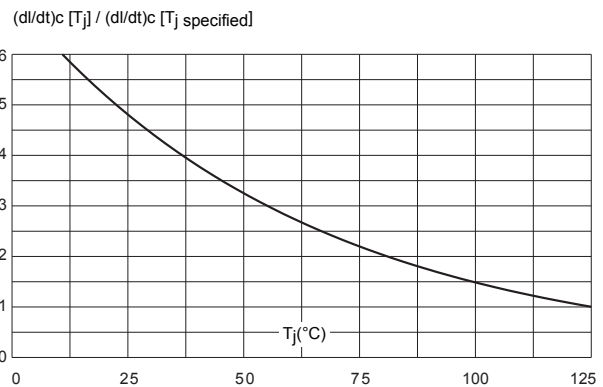

Figure 12. D²PAK thermal resistance junction to ambient versus copper surface under tab



2 Package information

In order to meet environmental requirements, ST offers these devices in different grades of ECOPACK® packages, depending on their level of environmental compliance. ECOPACK® specifications, grade definitions and product status are available at: www.st.com. ECOPACK® is an ST trademark.

2.1 TO-220AB Insulated and non Insulated package information

- Epoxy meets UL 94, V0
- Cooling method: by conduction (C)
- Recommended torque value: 0.55 N·m
- Maximum torque value: 0.70 N·m

Figure 13. TO-220AB Insulated and non Insulated package outline

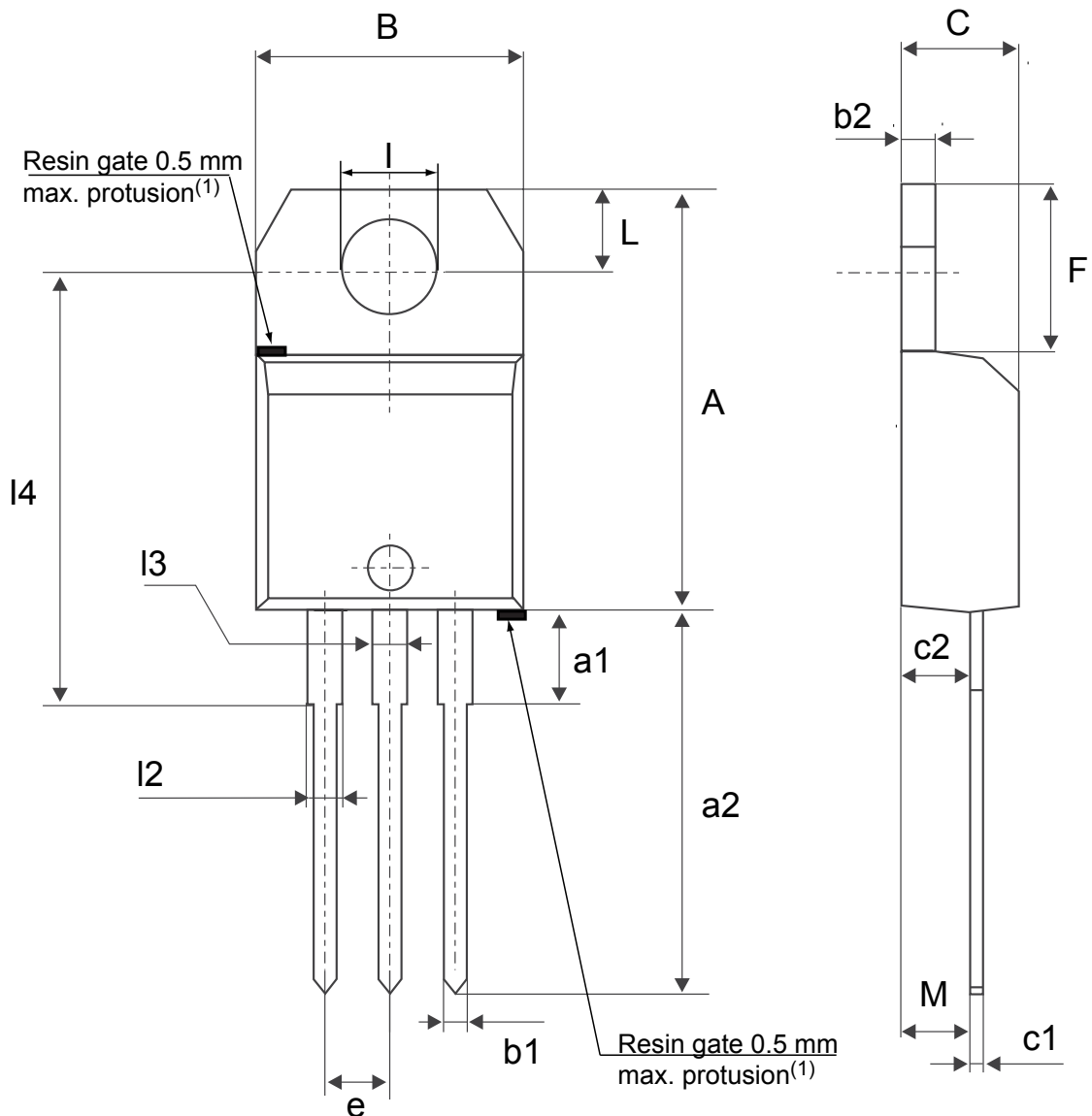

(1) Resin gate position accepted in one of the two positions or in the symmetrical opposites.

Table 6. TO-220AB Insulated and non Insulated package mechanical data

Ref.	Dimensions					
	Millimeters			Inches		
	Min.	Typ.	Max.	Min.	Typ.	Max.
A	15.20		15.90	0.5984		0.6260
a1		3.75			0.1476	
a2	13.00		14.00	0.5118		0.5512
B	10.00		10.40	0.3937		0.4094
b1	0.61		0.88	0.0240		0.0346
b2	1.23		1.32	0.0484		0.0520
C	4.40		4.60	0.1732		0.1811
c1	0.49		0.70	0.0193		0.0276
c2	2.40		2.72	0.0945		0.1071
e	2.40		2.70	0.0945		0.1063
F	6.20		6.60	0.2441		0.2598
I	3.73		3.88	0.1469		0.1528
L	2.65		2.95	0.1043		0.1161
I2	1.14		1.70	0.0449		0.0669
I3	1.14		1.70	0.0449		0.0669
I4	15.80	16.40	16.80	0.6220	0.6457	0.6614
M		2.6			0.1024	

1. Inch dimensions are for reference only.

2.2 D²PAK package information

Figure 14. D²PAK package outline



(1) Resin gate position accepted in one of the two positions or in the symmetrical opposites

Table 7. D²PAK package mechanical data

Ref.	Dimensions					
	Millimeters			Inches		
	Min.	Typ.	Max.	Min.	Typ.	Max.
A	4.30		4.60	0.1693		0.1811
A1	2.49		2.69	0.0980		0.1059
A2	0.03		0.23	0.0012		0.0091
A3		0.25			0.0098	
b	0.70		0.93	0.0276		0.0366
b2	1.25		1.7	0.0492		0.0669
c	0.45		0.60	0.0177		0.0236
c2	1.21		1.36	0.0476		0.0535
D	8.95		9.35	0.3524		0.3681
D1	7.50		8.00	0.2953		0.3150
D2	1.30		1.70	0.0512		0.0669
e	2.54			0.1		
E	10.00		10.28	0.3937		0.4047
E1	8.30		8.70	0.3268		0.3425
E2	6.85		7.25	0.2697		0.2854
G	4.88		5.28	0.1921		0.2079
H	15		15.85	0.5906		0.6240
L	1.78		2.28	0.0701		0.0898
L2	1.27		1.40	0.0500		0.0551
L3	1.40		1.75	0.0551		0.0689
R		0.40			0.0157	
V2	0°		8°	0°		8°

1. Dimensions in inches are given for reference only

Figure 15. D²PAK recommended footprint (dimensions are in mm)

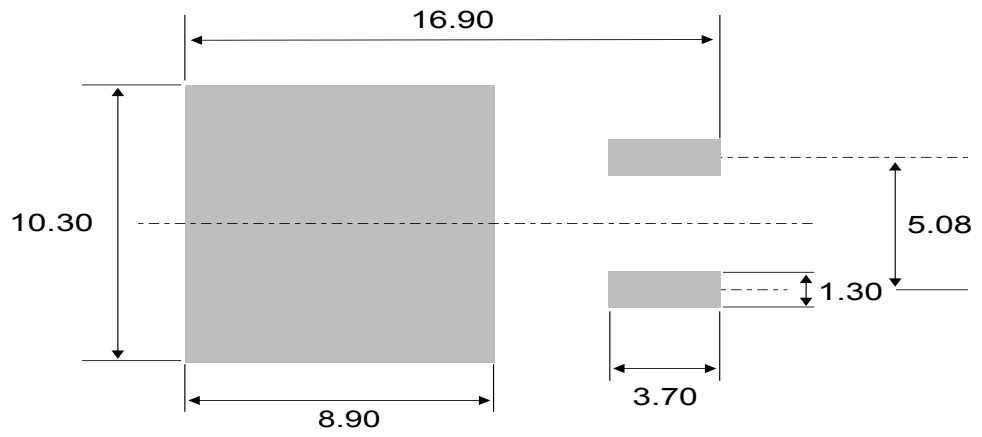

3 Ordering information

Figure 16. Ordering information scheme (BTA16 and BTB16 series)

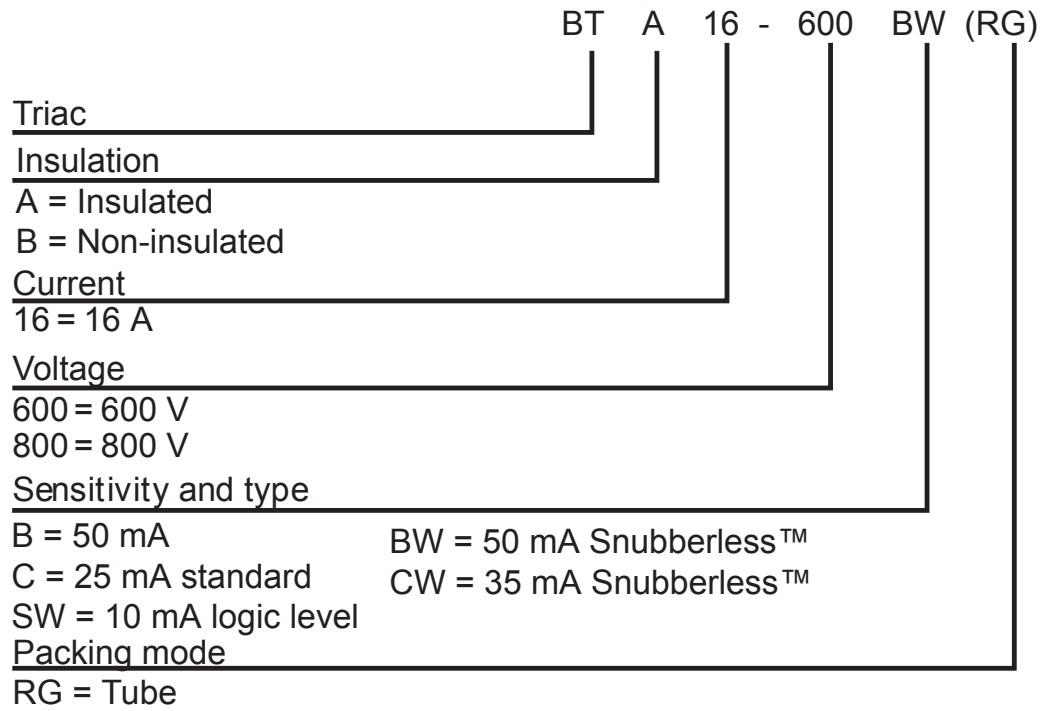
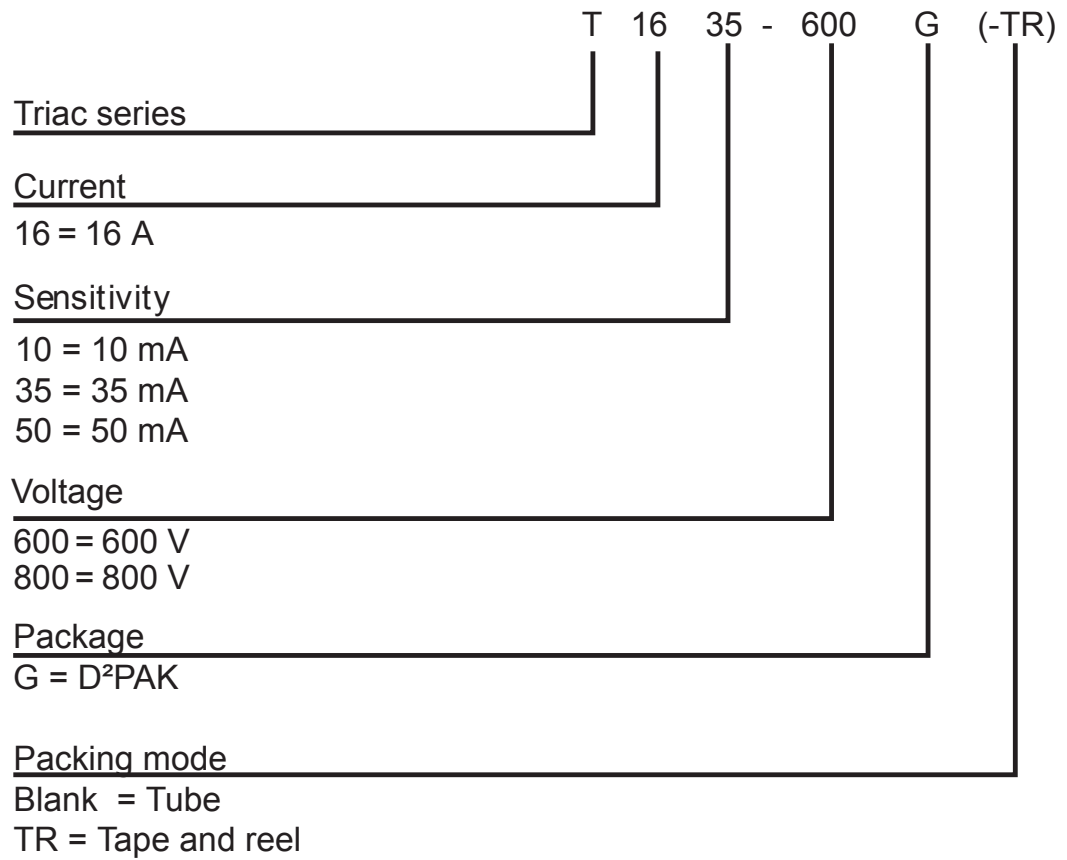

Figure 17. Ordering information scheme (T8 series)



3.1 Product selector

Table 8. Product selector

Part Number		Sensitivity	Type	Package
600	800			
BTB16-600C		35 mA	Standard	TO-220AB
BTB16-600B	BTB16-800B	50 mA	Standard	TO-220AB
BTB16-600SW	BTB16-800SW	10 mA	Snubberless™	TO-220AB
BTB16-600CW	BTB16-800CW	35 mA	Snubberless™	TO-220AB
BTB16-600BW	BTB16-800BW	50 mA	Snubberless™	TO-220AB
BTA16-600C		35 mA	Standard	TO-220AB Ins.
BTA16-600B	BTA16-800B	50 mA	Standard	TO-220AB Ins.
BTA16-600SW	BTA16-800SW	10 mA	Snubberless™	TO-220AB Ins.
BTA16-600CW	BTA16-800CW	35 mA	Snubberless™	TO-220AB Ins.
BTA16-600BW	BTA16-800BW	50 mA	Snubberless™	TO-220AB Ins.
T1610-600G	T1610-800G	10 mA	Snubberless™	D ² PAK
T1635-600G	T1635-800G	35 mA	Snubberless™	D ² PAK
T1650-600G		50 mA	Snubberless™	D ² PAK

3.2 Ordering information

Table 9. Ordering information

Order code	Marking	Package	Weight	Base qty.	Delivery mode
BTA16-600BRG	BTA16-600B	TO-220AB Ins.	2.30	50	Tube
BTA16-600BWRG	BTA16-600BW				
BTA16-600CRG	BTA16-600C				
BTA16-600CWRG	BTA16-600CW				
BTA16-600SWRG	BTA16-600SW				
BTA16-800BRG	BTA16-800B				
BTA16-800BWRG	BTA16-800BW				
BTA16-800CWRG	BTA16-800CW				
BTA16-800SWRG	BTA16-800SW				
BTB16-600BRG	BTB16-600B	TO-220AB			Tube
BTB16-600BWRG	BTB16-600BW				
BTB16-600CRG	BTB16-600C				
BTB16-600CWRG	BTB16-600CW				
BTB16-600SWRG	BTB16-600SW				
BTB16-800BRG	BTB16-800B				
BTB16-800BWRG	BTB16-800BW				
BTB16-800CWRG	BTB16-800CW				
BTB16-800SWRG	BTB16-800SW				
T1610-600G-TR	T1610-600G	D ² PAK	1.50	1000	Tape and reel
T1610-800G-TR	T1610-800G				
T1635-600G-TR	T1635-600G				
T1635-800G-TR	T1635-800G				
T1650-600G-TR	T1650-600G				
T1635-600G	T1635-600G			50	Tube

Revision history

Table 10. Document revision history

Date	Revision	Changes
Oct-2002	6A	Last update.
13-Feb-2006	7	TO-220AB delivery mode changed from bulk to tube. ECOPACK statement added.
03-Jul-2009	8	Added part number T1610.
04-Dec-2009	9	Updated value for V_{DSM} / V_{RSM} in Table 2. Updated temperature in Table 2 from 15 °C to 86 °C.
11-Mar-2010	10	Updated value for V_{DSM} / V_{RSM} in Table 2. Updated temperature in Table 2 from 15 °C to 86 °C.
30-May-2018	11	Updated Section • Product status / summary . Added T1650 package information.

IMPORTANT NOTICE – PLEASE READ CAREFULLY

STMicroelectronics NV and its subsidiaries (“ST”) reserve the right to make changes, corrections, enhancements, modifications, and improvements to ST products and/or to this document at any time without notice. Purchasers should obtain the latest relevant information on ST products before placing orders. ST products are sold pursuant to ST’s terms and conditions of sale in place at the time of order acknowledgement.

Purchasers are solely responsible for the choice, selection, and use of ST products and ST assumes no liability for application assistance or the design of Purchasers’ products.

No license, express or implied, to any intellectual property right is granted by ST herein.

Resale of ST products with provisions different from the information set forth herein shall void any warranty granted by ST for such product.

ST and the ST logo are trademarks of ST. All other product or service names are the property of their respective owners.

Information in this document supersedes and replaces information previously supplied in any prior versions of this document.

© 2018 STMicroelectronics – All rights reserved



Компания «ЭлектроПласт» предлагает заключение долгосрочных отношений при поставках импортных электронных компонентов на взаимовыгодных условиях!

Наши преимущества:

- Оперативные поставки широкого спектра электронных компонентов отечественного и импортного производства напрямую от производителей и с крупнейших мировых складов;
- Поставка более 17-ти миллионов наименований электронных компонентов;
- Поставка сложных, дефицитных, либо снятых с производства позиций;
- Оперативные сроки поставки под заказ (от 5 рабочих дней);
- Экспресс доставка в любую точку России;
- Техническая поддержка проекта, помощь в подборе аналогов, поставка прототипов;
- Система менеджмента качества сертифицирована по Международному стандарту ISO 9001;
- Лицензия ФСБ на осуществление работ с использованием сведений, составляющих государственную тайну;
- Поставка специализированных компонентов (Xilinx, Altera, Analog Devices, Intersil, Interpoint, Microsemi, Aeroflex, Peregrine, Syfer, Eurofarad, Texas Instrument, Miteq, Cobham, E2V, MA-COM, Hittite, Mini-Circuits, General Dynamics и др.);

Помимо этого, одним из направлений компании «ЭлектроПласт» является направление «Источники питания». Мы предлагаем Вам помощь Конструкторского отдела:

- Подбор оптимального решения, техническое обоснование при выборе компонента;
- Подбор аналогов;
- Консультации по применению компонента;
- Поставка образцов и прототипов;
- Техническая поддержка проекта;
- Защита от снятия компонента с производства.



Как с нами связаться

Телефон: 8 (812) 309 58 32 (многоканальный)

Факс: 8 (812) 320-02-42

Электронная почта: org@eplast1.ru

Адрес: 198099, г. Санкт-Петербург, ул. Калинина, дом 2, корпус 4, литера А.