

LOW ON RESISTANCE / LOW VOLTAGE 1A LDO

NO.EA-174-160426

OUTLINE

The RP131x Series are voltage-regulators with a built-in low ON-resistance transistor and output current is 1A capability. These ICs are capable of the low input voltage (Min.1.6V) and also the minimum output voltage can be set from 0.8V. (The output voltage is fixed in the IC.)

Each of these ICs consists of a voltage reference unit, an error amplifier, a resistor net for setting output voltage, a chip enable circuit, current limit circuits for over-current and short, and a thermal-shutdown circuit.

A standby mode with ultra low supply current can be realized with the chip enable function.

The packages for these ICs are DFN1616-6B and DFN(PLP)1820-6 which are suitable for high density mounting of the ICs on boards. SOT-89-5, HSOP-6J and TO-252-5-P2 with high power dissipation are also available.

FEATURES

- Output Current Min. 1A
- Supply Current Typ. 65 μ A
- Standby Current Typ. 0.15 μ A
- Input Voltage Range 1.6V to 6.5V
- Output Voltage Range 0.8V to 5.5V (0.1V steps)
(For other voltages, please refer to MARK INFORMATIONS.)
- Dropout Voltage..... Typ. 0.5V ($V_{OUT}=2.8V$, $I_{OUT}=1A$)
- Ripple Rejection Typ. 70dB ($f=1kHz$, $V_{OUT}=2.8V$)
- Output Voltage Accuracy $\pm 1.0\%$
- Temperature-Drift Coefficient of Output Voltage Typ. $\pm 100ppm/^{\circ}C$
- Line Regulation Typ. 0.05%/V
- Load Regulation Typ. 20mV at $I_{OUT}=300mA$, Typ. 80mV at $I_{OUT}=1A$
- Packages DFN1616-6B, DFN(PLP)1820-6, SOT-89-5, HSOP-6J, TO-252-5-P2
- Built-in Inrush current limit circuit Typ. 500mA
- Built-in Fold-Back Protection Circuit Typ. 250mA (Current at short mode)
- Built-in Thermal Shutdown Circuit Thermal Shutdown Temperature ; Typ. 165 $^{\circ}C$
Released Temperature ; Typ. 135 $^{\circ}C$
- Built-in Auto Discharge Function D version
- Ceramic capacitors are recommended to be used with this IC 2.2 μ F or more ($V_{OUT}\leq 3.6V$)
4.7 μ F or more ($V_{OUT}> 3.6V$)

APPLICATIONS

- Power source for battery-powered equipment.
- Power source for portable communication equipment.
- Power source for electrical appliances such as cameras, VCRs and camcorders.
- Power source for Notebook PC.
- Power source for home appliances.

RP131x

NO.EA-174-160426

BLOCK DIAGRAMS



SELECTION GUIDE

The output voltage, auto discharge function, package for the ICs can be selected at the user's request.

| Product Name | Package | Quantity per Reel | Pb Free | Halogen Free |
|------------------|----------------|-------------------|---------|--------------|
| RP131Lxx1*-TR | DFN1616-6B | 5,000 pcs | Yes | Yes |
| RP131Kxx1*-TR | DFN(PLP)1820-6 | 5,000 pcs | Yes | Yes |
| RP131Hxx1*-T1-FE | SOT-89-5 | 1,000 pcs | Yes | Yes |
| RP131Sxx1*-E2-FE | HSOP-6J | 1,000 pcs | Yes | Yes |
| RP131Jxx1*-T1-FE | TO-252-5-P2 | 3,000 pcs | Yes | Yes |

xx : The output voltage can be designated in the range from 0.8V(08) to 5.5V(55) in 0.1V steps.
(For other voltages, please refer to MARK INFORMATIONS.)

* : The auto discharge function at off state are options as follows.
(B) without auto discharge function at off state
(D) with auto discharge function at off state

PIN CONFIGURATIONS

● DFN1616-6B



● DFN(PLP)1820-6



● SOT-89-5



● HSOP-6J



● TO-252-5-P2



PIN DESCRIPTIONS

● DFN1616-6B

| Pin No. | Symbol | Pin Description |
|---------|-----------|------------------------------|
| 1 | V_{OUT} | Output Pin*2 |
| 2 | V_{OUT} | Output Pin*2 |
| 3 | GND | Ground Pin |
| 4 | CE | Chip Enable Pin ("H" Active) |
| 5 | V_{DD} | Input Pin*2 |
| 6 | V_{DD} | Input Pin*2 |

*1) Tab is GND level. (They are connected to the reverse side of this IC.)

The tab is better to be connected to the GND, but leaving it open is also acceptable.

*2) When you use this IC, please make sure be wired with 1pin with 2pin and 5pin with 6pin.

RP131x

NO.EA-174-160426

• DFN(PLP)1820-6

| Pin No. | Symbol | Pin Description |
|---------|------------------|------------------------------|
| 1 | V _{OUT} | Output Pin*2 |
| 2 | V _{OUT} | Output Pin*2 |
| 3 | GND | Ground Pin |
| 4 | CE | Chip Enable Pin ("H" Active) |
| 5 | V _{DD} | Input Pin*2 |
| 6 | V _{DD} | Input Pin*2 |

*1) Tab is GND level. (They are connected to the reverse side of this IC.)

The tab is better to be connected to the GND, but leaving it open is also acceptable.

*2) When you use this IC, please make sure be wired with 1pin with 2pin and 5pin with 6pin.

• SOT-89-5

| Pin No. | Symbol | Pin Description |
|---------|------------------|------------------------------|
| 1 | NC | No Connection |
| 2 | GND | Ground Pin |
| 3 | CE | Chip Enable Pin ("H" Active) |
| 4 | V _{DD} | Input Pin |
| 5 | V _{OUT} | Output Pin |

• HSOP-6J

| Pin No. | Symbol | Pin Description |
|---------|------------------|------------------------------|
| 1 | V _{OUT} | Output Pin |
| 2 | GND | Ground Pin*3 |
| 3 | NC | No Connection |
| 4 | CE | Chip Enable Pin ("H" Active) |
| 5 | GND | Ground Pin*3 |
| 6 | V _{DD} | Input Pin |

*3) When you use this IC, please make sure be wired with 2pin and 5pin.

• TO-252-5-P2

| Pin No. | Symbol | Pin Description |
|---------|------------------|------------------------------|
| 1 | V _{OUT} | Output Pin |
| 2 | GND | Ground Pin*4 |
| 3 | GND | Ground Pin*4 |
| 4 | CE | Chip Enable Pin ("H" Active) |
| 5 | V _{DD} | Input Pin |

*4) When you use this IC, please make sure be wired with 2pin and 3pin.

ABSOLUTE MAXIMUM RATINGS

| Symbol | Item | Rating | Unit |
|------------------|-------------------------------------|------------------------------|------|
| V _{IN} | Input Voltage | 7.0 | V |
| V _{CE} | Input Voltage (CE Pin) | -0.3 to 7.0 | V |
| V _{OUT} | Output Voltage | -0.3 to V _{IN} +0.3 | V |
| P _D | Power Dissipation (DFN1616-6B)* | 640 | mW |
| | Power Dissipation (DFN(PLP)1820-6)* | 880 | |
| | Power Dissipation (SOT-89-5)* | 900 | |
| | Power Dissipation (HSOP-6J)* | 1700 | |
| | Power Dissipation (TO-252-5-P2)* | 1900 | |
| T _{opt} | Operating Temperature Range | -40 to 85 | °C |
| T _{stg} | Storage Temperature Range | -55 to 125 | °C |

*) For Power Dissipation, please refer to PACKAGE INFORMATION.

ABSOLUTE MAXIMUM RATINGS

Electronic and mechanical stress momentarily exceeded absolute maximum ratings may cause the permanent damages and may degrade the life time and safety for both device and system using the device in the field.

The functional operation at or over these absolute maximum ratings is not assured.

RP131x

NO.EA-174-160426

ELECTRICAL CHARACTERISTICS $V_{IN} = \text{Set } V_{OUT} + 1V, I_{OUT} = 1mA$ The specification in is checked and guaranteed by design engineering at $-40^{\circ}\text{C} \leq T_{opt} \leq 85^{\circ}\text{C}$, unless otherwise noted.● **RP131xxx1B/D** $T_{opt} = 25^{\circ}\text{C}$

| Symbol | Item | Conditions | Min. | Typ. | Max. | Unit | |
|---|---|--|---|---|---|---|----|
| V_{OUT} | Output Voltage | $T_{opt} = 25^{\circ}\text{C}$ | $V_{OUT} > 1.5V$ | $\times 0.99$ | | $\times 1.01$ | V |
| | | | $V_{OUT} \leq 1.5V$ | -15 | | 15 | mV |
| | | $-40^{\circ}\text{C} \leq T_{opt} \leq 85^{\circ}\text{C}$ | $V_{OUT} > 1.5V$ | $\times 0.974$ | | $\times 1.018$ | V |
| | | | $V_{OUT} \leq 1.5V$ | -40 | | 27 | mV |
| $\frac{\Delta V_{OUT}}{\Delta I_{OUT}}$ | Load Regulation | $0.1mA \leq I_{OUT} \leq 300mA$ | | 20 | 40 | mV | |
| | | $0.1mA \leq I_{OUT} \leq 1A$ | | 80 | 120 | | |
| V_{DIF} | Dropout Voltage | Refer to the following table | | | | | |
| I_{SS} | Supply Current | $I_{OUT} = 0mA$ ($V_{IN} = 6.5V$) | | 65 | 90 | μA | |
| $I_{standby}$ | Standby Current | $V_{CE} = 0V, V_{IN} = 6.5V$ | | 0.15 | 0.60 | μA | |
| $\frac{\Delta V_{OUT}}{\Delta V_{IN}}$ | Line Regulation | Set $V_{OUT} + 0.5V \leq V_{IN} \leq 6.5V$ *However, $V_{IN} \geq 1.6V$ | | 0.05 | 0.1 | %/V | |
| RR | Ripple Rejection | $f = 1kHz$ Ripple 0.2Vp-p $I_{OUT} = 100mA$ | $V_{OUT} \leq 3.3V$ | | 70 | dB | |
| | | | $V_{OUT} > 3.3V$ | | 60 | | |
| V_{IN} | Input Voltage | | 1.6 | | 6.5 | V | |
| $\frac{\Delta V_{OUT}}{\Delta T_{opt}}$ | Output Voltage Temperature Coefficient | $-40^{\circ}\text{C} \leq T_{opt} \leq 85^{\circ}\text{C}$ | | ± 100 | | ppm/ $^{\circ}\text{C}$ | |
| I_{LIM} | Output Current Limit | | 1 | | | A | |
| I_{SC} | Short Current Limit | $V_{OUT} = 0V$ | | 250 | | mA | |
| I_{PD} | CE Pull-down Current | | | 0.3 | | μA | |
| V_{CEH} | CE Input Voltage "H" | | 1.0 | | | V | |
| V_{CEL} | CE Input Voltage "L" | | | | 0.4 | V | |
| e_n | Output Noise | $BW = 10Hz$ to $100kHz, I_{OUT} = 1mA$ | | 45 | | μV_{rms} | |
| T_{TSD} | Thermal Shutdown Temperature | Junction Temperature | | 165 | | $^{\circ}\text{C}$ | |
| T_{TSR} | Thermal Shutdown Released Temperature | Junction Temperature | | 135 | | $^{\circ}\text{C}$ | |
| R_{LOW} | Low Output Nch Tr. ON Resistance (of D version) | $V_{IN} = 4.0V, V_{CE} = 0V$ | | 30 | | Ω | |

The specification in is checked and guaranteed by design engineering at $-40^{\circ}\text{C} \leq T_{opt} \leq 85^{\circ}\text{C}$, unless otherwise noted.All of unit are tested and specified under load conditions such that $T_j \approx T_{opt} = 25^{\circ}\text{C}$ except for Output Noise, Ripple Rejection, Output Voltage Temperature Coefficient, Dropout Voltage at 1A Output Current and Thermal Shutdown items.

• Dropout Voltage by Output Voltage

T_{opt}=25°C

| Output Voltage V _{OUT} (V) | Dropout Voltage V _{DIF} (V) | | | | | |
|--|--------------------------------------|-------|-------|----------------------|-------|-------|
| | Condition | Typ. | Max. | Condition | Typ. | Max. |
| 0.8 ≤ V _{OUT} < 0.9 | I _{OUT} =300mA | 0.600 | 0.780 | I _{OUT} =1A | 1.100 | 1.650 |
| 0.9 ≤ V _{OUT} < 1.0 | | 0.550 | 0.690 | | 1.050 | 1.500 |
| 1.0 ≤ V _{OUT} < 1.1 | | 0.450 | 0.610 | | 1.000 | 1.450 |
| 1.1 ≤ V _{OUT} < 1.2 | | 0.340 | 0.540 | | 0.930 | 1.420 |
| 1.2 ≤ V _{OUT} < 1.5 | | 0.290 | 0.500 | | 0.900 | 1.380 |
| 1.5 ≤ V _{OUT} < 2.6 | | 0.230 | 0.310 | | 0.700 | 1.100 |
| 2.6 ≤ V _{OUT} < 3.3 | | 0.150 | 0.180 | | 0.500 | 0.750 |
| 3.3 ≤ V _{OUT} ≤ 5.5 | | 0.140 | 0.170 | | 0.450 | 0.650 |

The specification in is checked and guaranteed by design engineering at -40°C ≤ T_{opt} ≤ 85°C, unless otherwise noted.

All of unit are tested and specified under load conditions such that T_j ≈ T_{opt} = 25°C except for Output Noise, Ripple Rejection, Output Voltage Temperature Coefficient, Dropout Voltage at 1A Output Current and Thermal Shutdown items.

RECOMMENDED OPERATING CONDITIONS (ELECTRICAL CHARACTERISTICS)

All of electronic equipment should be designed that the mounted semiconductor devices operate within the recommended operating conditions. The semiconductor devices cannot operate normally over the recommended operating conditions, even if when they are used over such conditions by momentary electronic noise or surge.

And the semiconductor devices may receive serious damage when they continue to operate over the recommended operating conditions.

TYPICAL APPLICATION



Recommendation value of the external capacitors

| V_{OUT} | Capacitors | |
|---------------------|------------|--|
| $V_{OUT} \leq 3.6V$ | C1 | Kyocera 2.2 μ F (size:1005) [CM05X5R225M06AB] |
| | C2 | Kyocera 2.2 μ F (size:1608) [CM105X5R225K06AB] |
| $V_{OUT} > 3.6V$ | C1 | Kyocera 2.2 μ F (size:1608) [CM105X5R225K06AB] |
| | C2 | Kyocera 4.7 μ F (size:1608) [CM105X5R475M06AB] |

TECHNICAL NOTES

When using these ICs, consider the following points:

Phase Compensation

In these ICs, phase compensation is made for securing stable operation even if the load current is varied. For this purpose, use a capacitor C2 with good frequency characteristics and ESR (Equivalent Series Resistance).

If a tantalum capacitor is used, and its ESR of C2 is large, the loop oscillation may result. Because of this, select C2 carefully considering its frequency characteristics.

PCB Layout

Make V_{DD} and GND lines sufficient. If their impedance is high, noise pickup or unstable operation may result. Connect a capacitor C1 between V_{DD} and GND pin with a capacitance value as "Recommendation value of the external capacitors" above or more, and as close as possible to the pins.

Set external components, especially the output capacitor C2, as close as possible to the ICs, and make wiring as short as possible.

TEST CIRCUITS



Basic Test Circuit



Test Circuit for Supply Current



Test Circuit for Ripple Rejection



Test Circuit for Load Transient Response

TYPICAL CHARACTERISTICS

1) Output Voltage vs. Output Current (T_{opt}=25°C)



2) Output Voltage vs. Input Voltage (T_{opt}=25°C)



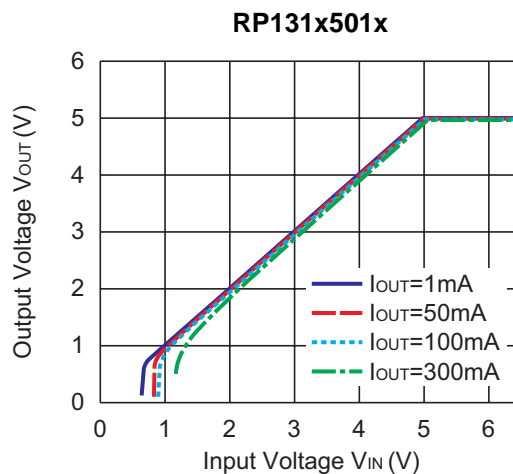

3) Supply Current vs. Input Voltage (Topt=25°C)

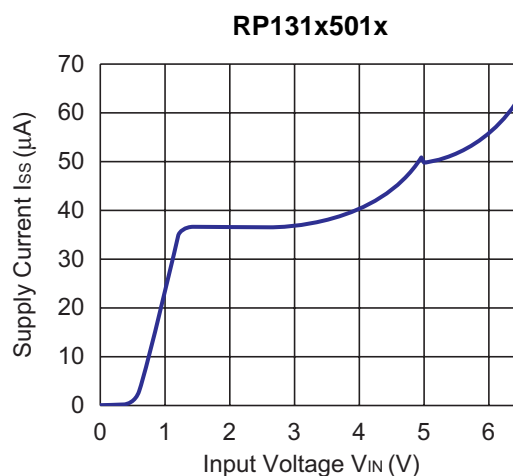
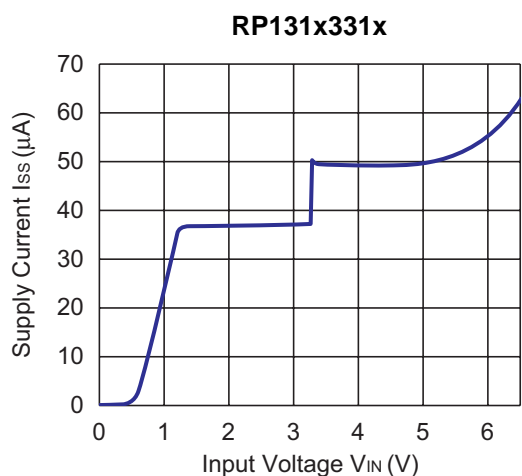
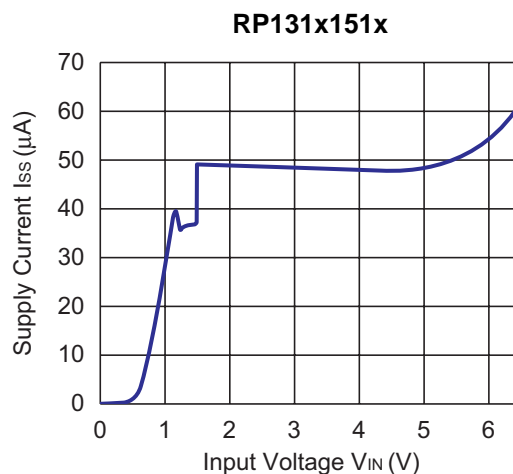

RP131xNO.EA-174-160426

4) Output Voltage vs. Temperature**5) Supply Current vs. Temperature**

RP131x331x



RP131x501x



6) Dropout Voltage vs. Output Current

RP131x081x



RP131x151x



RP131x331x



RP131x501x



RP131x

NO.EA-174-160426

7) Dropout Voltage vs. Set Output Voltage



8) Ripple Rejection vs. Input Bias Voltage ($C1=none$, $C2=Ceramic\ 1.0\mu F$, $Ripple=0.2V_{pp}$, $T_{opt}=25^{\circ}C$)





9) Ripple Rejection vs. Frequency ($C1=\text{none}$, $C2=\text{Ceramic } 4.7\mu\text{F}$, $T_{opt}=25^\circ\text{C}$)



RP131x

NO.EA-174-160426

10) Input Transient Response ($I_{OUT}=100\text{mA}$, $t_r=t_f=5\mu\text{s}$, $C_1=\text{none}$, $T_{opt}=25^\circ\text{C}$)



11) Load Transient Response ($t_r=t_f=0.5\mu\text{s}$, $C_1=\text{Ceramic } 2.2\mu\text{F}$, $V_{IN}=V_{OUT}+1.0\text{V}$, $T_{opt}=25^\circ\text{C}$)



RP131x331x

C2=Ceramic4.7 μ F



RP131x501x

C2=Ceramic4.7 μ F



RP131x081x

C2=Ceramic2.2 μ F



RP131x151x

C2=Ceramic2.2 μ F



RP131x331x

C2=Ceramic4.7 μ F



RP131x501x

C2=Ceramic4.7 μ F



RP131x

NO.EA-174-160426

RP131x081x



RP131x151x



RP131x331x



RP131x501x



12) Turn On Speed with CE pin (C1=Ceramic 2.2 μ F, C2=Ceramic 4.7 μ F, T_{opt}=25 $^{\circ}$ C)

RP131x081x



RP131x501x



13) Turn Off Speed with CE pin (D Version) (C1=Ceramic 2.2μF, C2=Ceramic 4.7μF, T_{opt}=25°C)



14) Inrush Current at turning on (C1=Ceramic 2.2μF, C2=Ceramic 4.7μF, T_{opt}=25°C)



15) Minimum Operating Voltage



Hatched area is available for 0.8V output.

ESR vs. Output Current

When using these ICs, consider the following points:

The relations between I_{OUT} (Output Current) and ESR of an output capacitor are shown below.

The conditions when the white noise level is under $40\mu\text{V}$ (Avg.) are marked as the hatched area in the graph.

Measurement conditions

Frequency Band : 10Hz to 3MHz

Temperature : -40°C to 85°C

C1 : $2.2\mu\text{F}$ (Kyocera, CM05X5R225M04AD)

C2 : $2.2\mu\text{F}$ (Kyocera, CM105X5R225K06AE)

$4.7\mu\text{F}$ (Kyocera, CM105X5R475M06AB)

RP131x081x

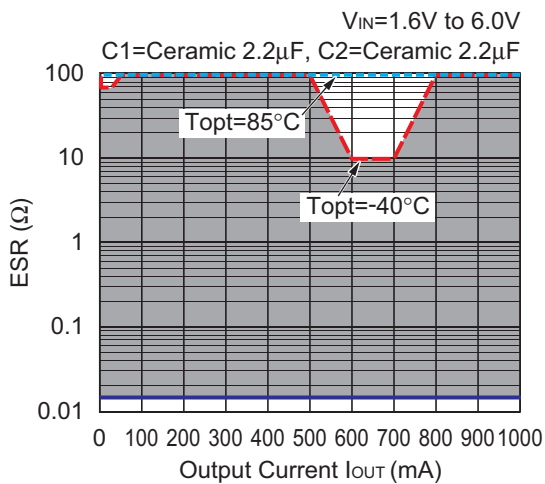

RP131x151x

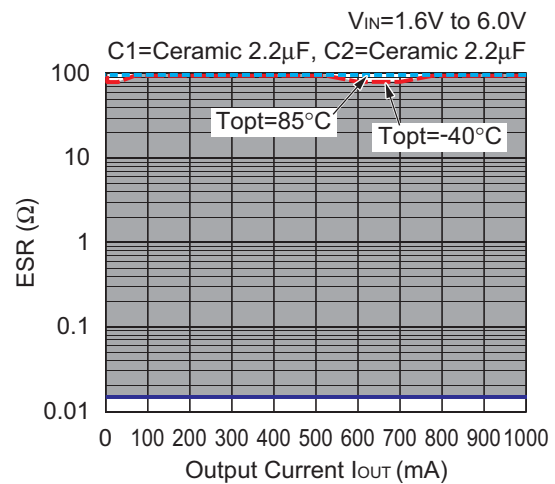

RP131x331x

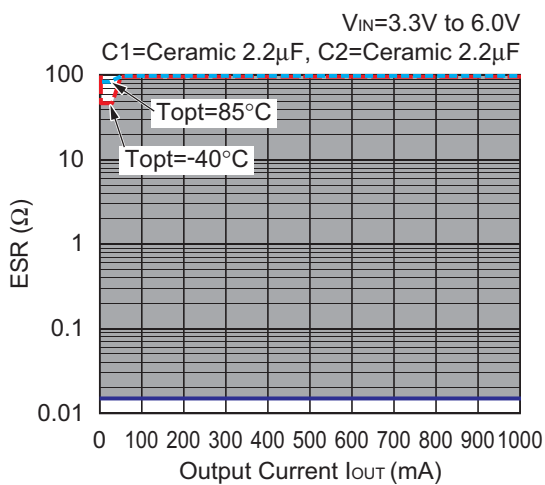

RP131x501x

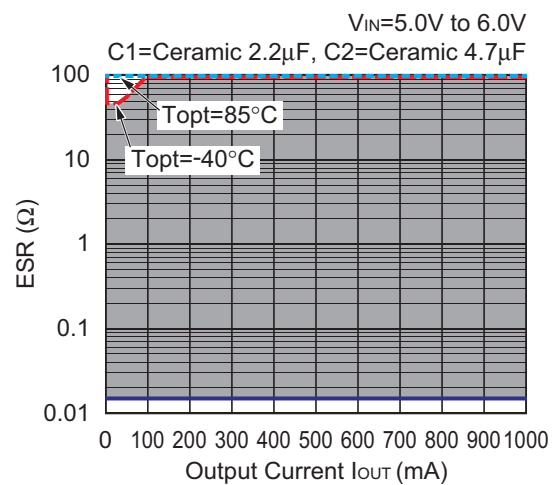

PACKAGE INFORMATION

Power Dissipation (DFN1616-6B)

This specification is at mounted on board. Power Dissipation (P_D) depends on conditions of mounting on board. This specification is based on the measurement at the condition below:

* Measurement Conditions

| | |
|------------------|---|
| | Standard Test Land Pattern |
| Environment | Mounting on Board (Wind velocity=0m/s) |
| Board Material | Glass cloth epoxy plastic (Double-sided) |
| Board Dimensions | 40mm*40mm*1.6mm |
| Copper Ratio | Top side: Approx. 50%, Back side: Approx. 50% |
| Through-holes | ϕ 0.5mm * 32pcs |

Measurement Result

($T_a=25^\circ\text{C}$)

| | |
|--------------------|---|
| | Standard Test Land Pattern |
| Power Dissipation | 640mW ($T_{j\text{max}}=125^\circ\text{C}$) 820mW ($T_{j\text{max}}=150^\circ\text{C}$) |
| Thermal Resistance | $\theta_{ja} = (125-25^\circ\text{C})/0.64\text{W} = 156^\circ\text{C/W}$ $\theta_{jc} = 23^\circ\text{C/W}$ |



Power Dissipation



Measurement Board Pattern

IC Mount Area (Unit: mm)

The above graph shows the Power Dissipation of the package based on $T_{j\text{max}}=125^\circ\text{C}$ and $T_{j\text{max}}=150^\circ\text{C}$. Operating the IC in the shaded area in the graph might have an influence it's lifetime. Operating time must be within the time limit described in the table below, in case of operating in the shaded area.

| | |
|----------------|---|
| Operating Time | Estimated years (Operating four hours/day) |
| 13,000 hours | 9years |

RP131x

NO.EA-174-160426

Package Dimensions (DFN1616-6B)

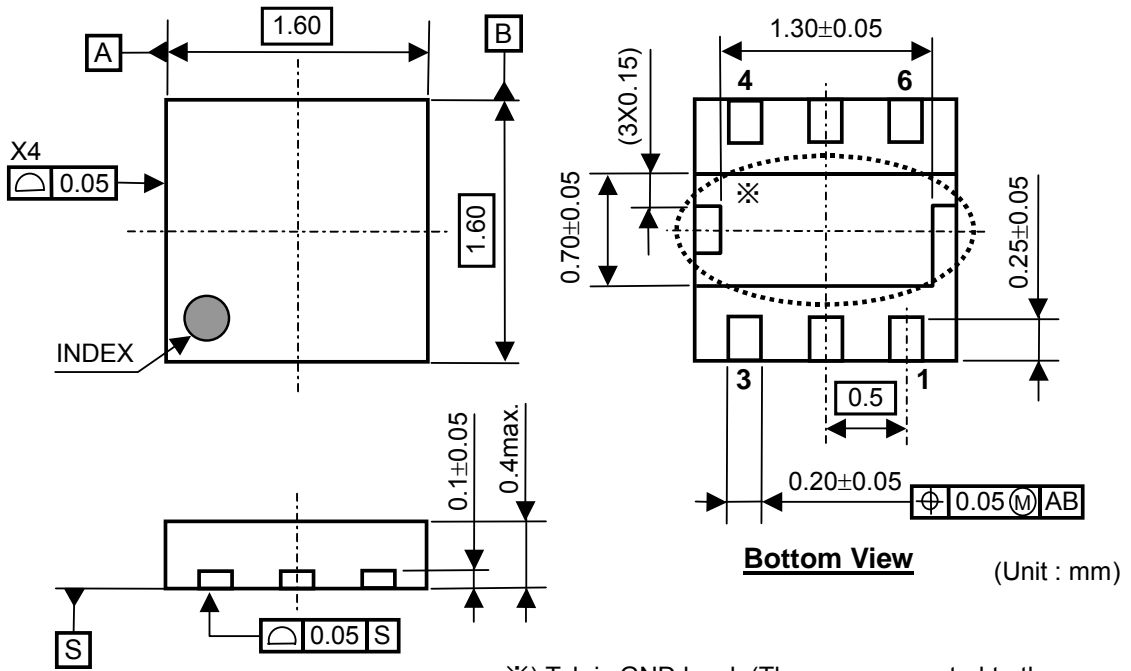

※) Tab is GND level. (They are connected to the reverse side of this IC.)
The tab is better to be connected to the GND, but leaving it open is also acceptable.

Mark Specifications (DFN1616-6B)



①②③④: Product Code ... Refer to RP131L Series Mark Specification Table.

⑤⑥: Lot Number ... Alphanumeric Serial Number

RP131L Series Mark Specification Table

PKG: DFN1616-6B

RP131Lxx1B

| Part Number | ①②③④ | Vset |
|-------------|--------------|-------|
| RP131L081B | CB 01 | 0.8V |
| RP131L091B | CB 02 | 0.9V |
| RP131L101B | CB 03 | 1.0V |
| RP131L111B | CB 04 | 1.1V |
| RP131L121B | CB 05 | 1.2V |
| RP131L121B5 | CB 06 | 1.25V |
| RP131L131B | CB 07 | 1.3V |
| RP131L141B | CB 08 | 1.4V |
| RP131L151B | CB 09 | 1.5V |
| RP131L161B | CB 10 | 1.6V |
| RP131L171B | CB 11 | 1.7V |
| RP131L181B | CB 12 | 1.8V |
| RP131L181B5 | CB 13 | 1.85V |
| RP131L191B | CB 14 | 1.9V |
| RP131L201B | CB 15 | 2.0V |
| RP131L211B | CB 16 | 2.1V |
| RP131L221B | CB 17 | 2.2V |
| RP131L231B | CB 18 | 2.3V |
| RP131L241B | CB 19 | 2.4V |
| RP131L251B | CB 20 | 2.5V |
| RP131L261B | CB 21 | 2.6V |
| RP131L271B | CB 22 | 2.7V |
| RP131L281B | CB 23 | 2.8V |
| RP131L281B5 | CB 24 | 2.85V |
| RP131L291B | CB 25 | 2.9V |
| RP131L301B | CB 26 | 3.0V |
| RP131L311B | CB 27 | 3.1V |
| RP131L321B | CB 28 | 3.2V |
| RP131L331B | CB 29 | 3.3V |
| RP131L341B | CB 30 | 3.4V |
| RP131L351B | CB 31 | 3.5V |
| RP131L361B | CB 32 | 3.6V |
| RP131L371B | CB 33 | 3.7V |
| RP131L381B | CB 34 | 3.8V |
| RP131L391B | CB 35 | 3.9V |
| RP131L401B | CB 36 | 4.0V |
| RP131L411B | CB 37 | 4.1V |
| RP131L421B | CB 38 | 4.2V |
| RP131L431B | CB 39 | 4.3V |
| RP131L441B | CB 40 | 4.4V |
| RP131L451B | CB 41 | 4.5V |
| RP131L461B | CB 42 | 4.6V |
| RP131L471B | CB 43 | 4.7V |
| RP131L481B | CB 44 | 4.8V |
| RP131L491B | CB 45 | 4.9V |
| RP131L501B | CB 46 | 5.0V |
| RP131L101B5 | CB 47 | 1.05V |
| RP131L511B | CB 48 | 5.1V |
| RP131L521B | CB 49 | 5.2V |
| RP131L531B | CB 50 | 5.3V |
| RP131L541B | CB 51 | 5.4V |
| RP131L551B | CB 52 | 5.5V |

RP131Lxx1D

| Part Number | ①②③④ | Vset |
|-------------|--------------|-------|
| RP131L081D | CC 01 | 0.8V |
| RP131L091D | CC 02 | 0.9V |
| RP131L101D | CC 03 | 1.0V |
| RP131L111D | CC 04 | 1.1V |
| RP131L121D | CC 05 | 1.2V |
| RP131L121D5 | CC 06 | 1.25V |
| RP131L131D | CC 07 | 1.3V |
| RP131L141D | CC 08 | 1.4V |
| RP131L151D | CC 09 | 1.5V |
| RP131L161D | CC 10 | 1.6V |
| RP131L171D | CC 11 | 1.7V |
| RP131L181D | CC 12 | 1.8V |
| RP131L181D5 | CC 13 | 1.85V |
| RP131L191D | CC 14 | 1.9V |
| RP131L201D | CC 15 | 2.0V |
| RP131L211D | CC 16 | 2.1V |
| RP131L221D | CC 17 | 2.2V |
| RP131L231D | CC 18 | 2.3V |
| RP131L241D | CC 19 | 2.4V |
| RP131L251D | CC 20 | 2.5V |
| RP131L261D | CC 21 | 2.6V |
| RP131L271D | CC 22 | 2.7V |
| RP131L281D | CC 23 | 2.8V |
| RP131L281D5 | CC 24 | 2.85V |
| RP131L291D | CC 25 | 2.9V |
| RP131L301D | CC 26 | 3.0V |
| RP131L311D | CC 27 | 3.1V |
| RP131L321D | CC 28 | 3.2V |
| RP131L331D | CC 29 | 3.3V |
| RP131L341D | CC 30 | 3.4V |
| RP131L351D | CC 31 | 3.5V |
| RP131L361D | CC 32 | 3.6V |
| RP131L371D | CC 33 | 3.7V |
| RP131L381D | CC 34 | 3.8V |
| RP131L391D | CC 35 | 3.9V |
| RP131L401D | CC 36 | 4.0V |
| RP131L411D | CC 37 | 4.1V |
| RP131L421D | CC 38 | 4.2V |
| RP131L431D | CC 39 | 4.3V |
| RP131L441D | CC 40 | 4.4V |
| RP131L451D | CC 41 | 4.5V |
| RP131L461D | CC 42 | 4.6V |
| RP131L471D | CC 43 | 4.7V |
| RP131L481D | CC 44 | 4.8V |
| RP131L491D | CC 45 | 4.9V |
| RP131L501D | CC 46 | 5.0V |
| RP131L101D5 | CC 47 | 1.05V |
| RP131L511D | CC 48 | 5.1V |
| RP131L521D | CC 49 | 5.2V |
| RP131L531D | CC 50 | 5.3V |
| RP131L541D | CC 51 | 5.4V |
| RP131L551D | CC 52 | 5.5V |

RP131x

NO.EA-174-160426

Power Dissipation (DFN(PLP)1820-6)

This specification is at mounted on board. Power Dissipation (P_D) depends on conditions of mounting on board. This specification is based on the measurement at the condition below:

Measurement Conditions

| | Standard Land Pattern |
|------------------|---|
| Environment | Mounting on Board (Wind velocity=0m/s) |
| Board Material | Glass cloth epoxy plastic (Double-sided) |
| Board Dimensions | 40mm * 40mm * 1.6mm |
| Copper Ratio | Top side: Approx. 50%, Back side: Approx. 50% |
| Through-hole | $\phi 0.54\text{mm} * 30\text{pcs}$ |

Measurement Result

($T_a=25^\circ\text{C}$)

| | Standard Land Pattern |
|--------------------|---|
| Power Dissipation | 880mW($T_{j\text{max}}=125^\circ\text{C}$) 1100mW($T_{j\text{max}}=150^\circ\text{C}$) |
| Thermal Resistance | $\theta_{ja}=(125 - 25^\circ\text{C})/0.88\text{W}=114^\circ\text{C/W}$ |

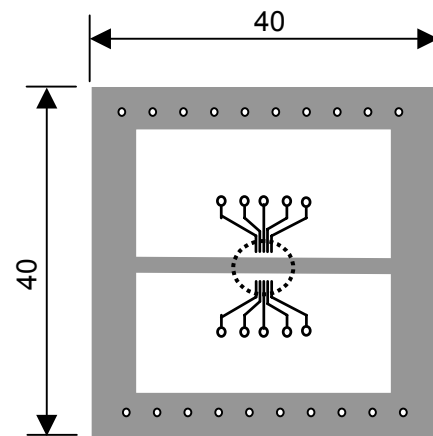
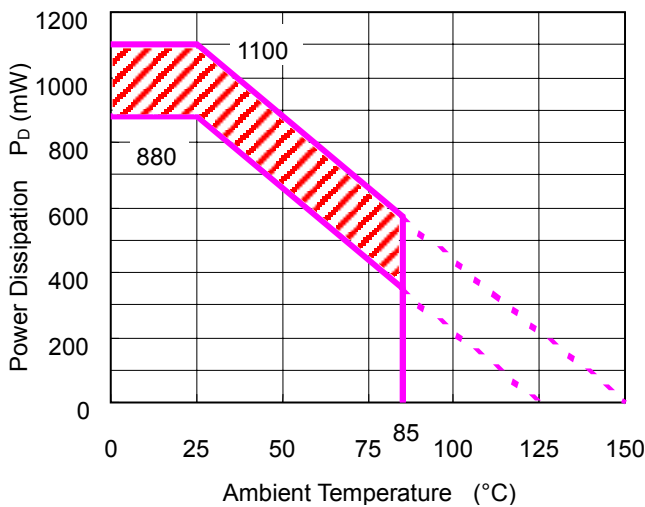

Measurement Board Pattern

○ IC Mount Area Unit: mm

- The above graph shows the Power Dissipation of the package based on $T_{j\text{max}}=125^\circ\text{C}$ and $T_{j\text{max}}=150^\circ\text{C}$. Operating the IC in the shaded area in the graph might have an influence it's lifetime.

Operating time must be within the time limit described in the table below, in case of operating in the shaded area.

| Operating Time | Estimated years (Operating four hours/day) |
|----------------|---|
| 13,000 hours | 9years |

Package Dimensions (DFN(PLP)1820-6)

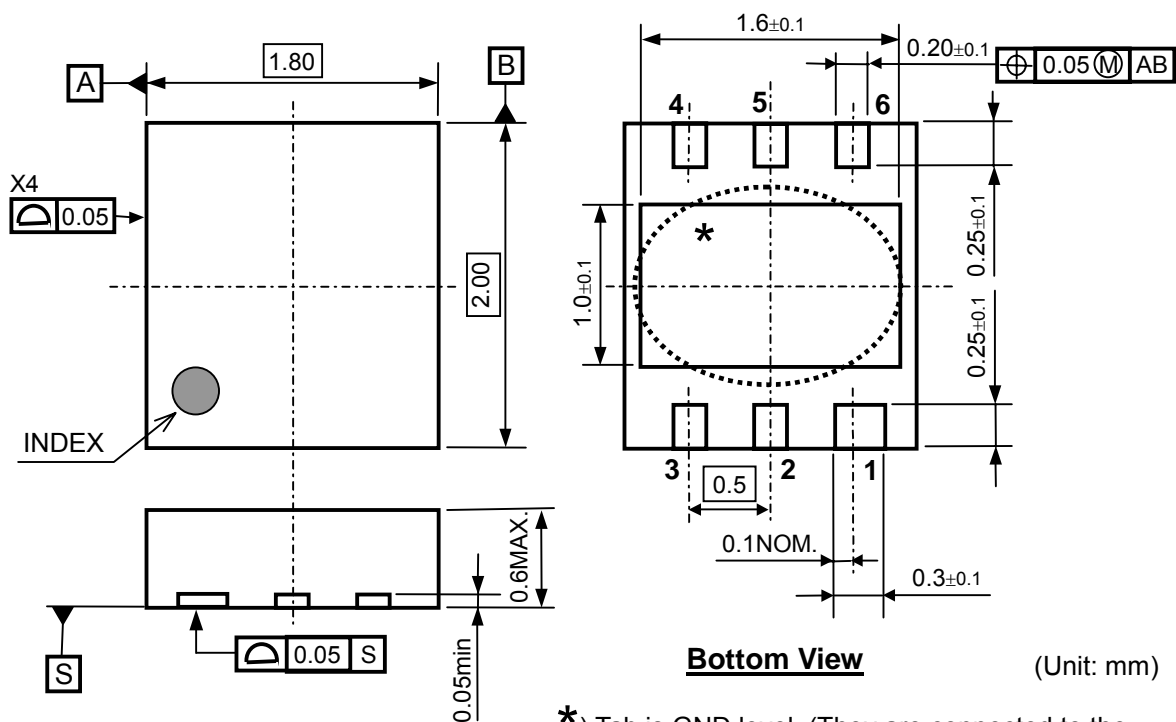

*) Tab is GND level. (They are connected to the reverse side of this IC.)
 The tab is better to be connected to the GND, but leaving it open is also acceptable.

Mark Specifications (DFN(PLP)1820-6)

①②③④: Product Code ...Refer to RP131K Series Mark Specification Table.

⑤⑥: Lot Number ... Alphanumeric Serial Number

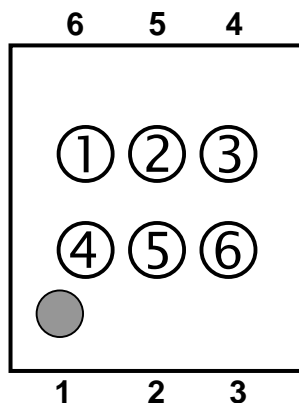

RP131K Series Mark Specification Table

PKG: DFN(PLP)1820-6

RP131Kxx1B

| Part Number | ①②③④ | Vset |
|-------------|--------------|-------|
| RP131K081B | AM 01 | 0.8V |
| RP131K091B | AM 02 | 0.9V |
| RP131K101B | AM 03 | 1.0V |
| RP131K111B | AM 04 | 1.1V |
| RP131K121B | AM 05 | 1.2V |
| RP131K121B5 | AM 06 | 1.25V |
| RP131K131B | AM 07 | 1.3V |
| RP131K141B | AM 08 | 1.4V |
| RP131K151B | AM 09 | 1.5V |
| RP131K161B | AM 10 | 1.6V |
| RP131K171B | AM 11 | 1.7V |
| RP131K181B | AM 12 | 1.8V |
| RP131K181B5 | AM 13 | 1.85V |
| RP131K191B | AM 14 | 1.9V |
| RP131K201B | AM 15 | 2.0V |
| RP131K211B | AM 16 | 2.1V |
| RP131K221B | AM 17 | 2.2V |
| RP131K231B | AM 18 | 2.3V |
| RP131K241B | AM 19 | 2.4V |
| RP131K251B | AM 20 | 2.5V |
| RP131K261B | AM 21 | 2.6V |
| RP131K271B | AM 22 | 2.7V |
| RP131K281B | AM 23 | 2.8V |
| RP131K281B5 | AM 24 | 2.85V |
| RP131K291B | AM 25 | 2.9V |
| RP131K301B | AM 26 | 3.0V |
| RP131K311B | AM 27 | 3.1V |
| RP131K321B | AM 28 | 3.2V |
| RP131K331B | AM 29 | 3.3V |
| RP131K341B | AM 30 | 3.4V |
| RP131K351B | AM 31 | 3.5V |
| RP131K361B | AM 32 | 3.6V |
| RP131K371B | AM 33 | 3.7V |
| RP131K381B | AM 34 | 3.8V |
| RP131K391B | AM 35 | 3.9V |
| RP131K401B | AM 36 | 4.0V |
| RP131K411B | AM 37 | 4.1V |
| RP131K421B | AM 38 | 4.2V |
| RP131K431B | AM 39 | 4.3V |
| RP131K441B | AM 40 | 4.4V |
| RP131K451B | AM 41 | 4.5V |
| RP131K461B | AM 42 | 4.6V |
| RP131K471B | AM 43 | 4.7V |
| RP131K481B | AM 44 | 4.8V |
| RP131K491B | AM 45 | 4.9V |
| RP131K501B | AM 46 | 5.0V |
| RP131K101B5 | AM 47 | 1.05V |
| RP131K551B | AM 48 | 5.5V |
| RP131K511B | AM 49 | 5.1V |
| RP131K521B | AM 50 | 5.2V |
| RP131K531B | AM 51 | 5.3V |
| RP131K541B | AM 52 | 5.4V |

RP131Kxx1D

| Part Number | ①②③④ | Vset |
|-------------|--------------|-------|
| RP131K081D | AN 01 | 0.8V |
| RP131K091D | AN 02 | 0.9V |
| RP131K101D | AN 03 | 1.0V |
| RP131K111D | AN 04 | 1.1V |
| RP131K121D | AN 05 | 1.2V |
| RP131K121D5 | AN 06 | 1.25V |
| RP131K131D | AN 07 | 1.3V |
| RP131K141D | AN 08 | 1.4V |
| RP131K151D | AN 09 | 1.5V |
| RP131K161D | AN 10 | 1.6V |
| RP131K171D | AN 11 | 1.7V |
| RP131K181D | AN 12 | 1.8V |
| RP131K181D5 | AN 13 | 1.85V |
| RP131K191D | AN 14 | 1.9V |
| RP131K201D | AN 15 | 2.0V |
| RP131K211D | AN 16 | 2.1V |
| RP131K221D | AN 17 | 2.2V |
| RP131K231D | AN 18 | 2.3V |
| RP131K241D | AN 19 | 2.4V |
| RP131K251D | AN 20 | 2.5V |
| RP131K261D | AN 21 | 2.6V |
| RP131K271D | AN 22 | 2.7V |
| RP131K281D | AN 23 | 2.8V |
| RP131K281D5 | AN 24 | 2.85V |
| RP131K291D | AN 25 | 2.9V |
| RP131K301D | AN 26 | 3.0V |
| RP131K311D | AN 27 | 3.1V |
| RP131K321D | AN 28 | 3.2V |
| RP131K331D | AN 29 | 3.3V |
| RP131K341D | AN 30 | 3.4V |
| RP131K351D | AN 31 | 3.5V |
| RP131K361D | AN 32 | 3.6V |
| RP131K371D | AN 33 | 3.7V |
| RP131K381D | AN 34 | 3.8V |
| RP131K391D | AN 35 | 3.9V |
| RP131K401D | AN 36 | 4.0V |
| RP131K411D | AN 37 | 4.1V |
| RP131K421D | AN 38 | 4.2V |
| RP131K431D | AN 39 | 4.3V |
| RP131K441D | AN 40 | 4.4V |
| RP131K451D | AN 41 | 4.5V |
| RP131K461D | AN 42 | 4.6V |
| RP131K471D | AN 43 | 4.7V |
| RP131K481D | AN 44 | 4.8V |
| RP131K491D | AN 45 | 4.9V |
| RP131K501D | AN 46 | 5.0V |
| RP131K101D5 | AN 47 | 1.05V |
| RP131K551D | AN 48 | 5.5V |
| RP131K511D | AN 49 | 5.1V |
| RP131K521D | AN 50 | 5.2V |
| RP131K531D | AN 51 | 5.3V |
| RP131K541D | AN 52 | 5.4V |

Power Dissipation (SOT-89-5)

This specification is at mounted on board. Power Dissipation (P_D) depends on conditions of mounting on board. This specification is based on the measurement at the condition below:

Measurement Conditions

| | High Wattage Land Pattern | Standard Land Pattern |
|------------------|--|--|
| Environment | Mounting on Board (Wind velocity=0m/s) | Mounting on Board (Wind velocity=0m/s) |
| Board Material | Glass cloth epoxy plastic (Double-sided) | Glass cloth epoxy plastic (Double-sided) |
| Board Dimensions | 30mm * 30mm * 1.6mm | 50mm * 50mm * 1.6mm |
| Copper Ratio | Top side: Approx. 20% Back side: Approx. 100% | Top side: Approx. 10% Back side: Approx. 100% |
| Through-hole | ϕ 0.85mm * 10pcs | - |

Measurement Result

($T_a=25^\circ\text{C}$)

| | High Wattage Land Pattern | Standard Land Pattern | Free Air |
|--------------------|---------------------------|---|----------|
| Power Dissipation | 1300mW | 900mW ($T_{jmax}=125^\circ\text{C}$) 1125mW ($T_{jmax}=150^\circ\text{C}$) | 500mW |
| Thermal Resistance | 77°C/W | 111°C/W | 200°C/W |

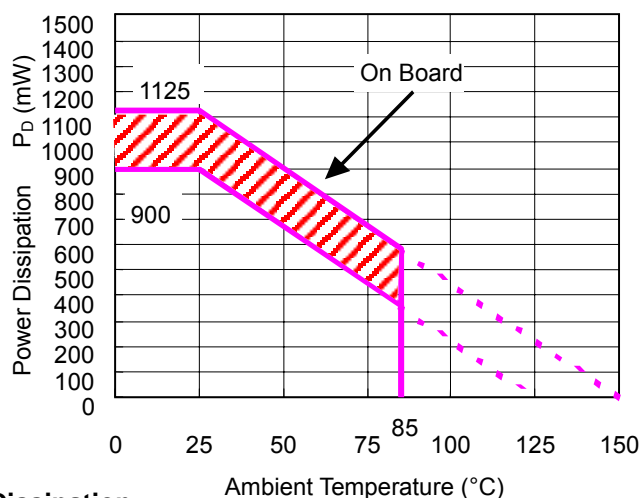

Power Dissipation



Measurement Board Pattern

○ IC Mount Area Unit: mm

- The above graph shows the Power Dissipation of the package based on $T_{jmax}=125^\circ\text{C}$ and $T_{jmax}=150^\circ\text{C}$.

Operating the IC in the shaded area in the graph might have an influence it's lifetime.

Operating time must be within the time limit described in the table below, in case of operating in the shaded area.

| Operating Time | Estimated years (Operating four hours/day) |
|----------------|---|
| 4,500 hours | 3years |

RP131x

NO.EA-174-160426

Package Dimensions (SOT-89-5)



Mark Specifications (SOT-89-5)

①②③④: Product Code ... Refer to RP131H Series Mark Specification Table.

⑤⑥: Lot Number ... Alphanumeric Serial Number



RP131H Series Mark Specification Table

PKG: SOT-89-5

RP131Hxx1B

| Part Number | ①②③④ | Vset |
|-------------|----------------|-------|
| RP131H081B | U 0 8 B | 0.8V |
| RP131H091B | U 0 9 B | 0.9V |
| RP131H101B | U 1 0 B | 1.0V |
| RP131H111B | U 1 1 B | 1.1V |
| RP131H121B | U 1 2 B | 1.2V |
| RP131H131B | U 1 3 B | 1.3V |
| RP131H141B | U 1 4 B | 1.4V |
| RP131H151B | U 1 5 B | 1.5V |
| RP131H161B | U 1 6 B | 1.6V |
| RP131H171B | U 1 7 B | 1.7V |
| RP131H181B | U 1 8 B | 1.8V |
| RP131H191B | U 1 9 B | 1.9V |
| RP131H201B | U 2 0 B | 2.0V |
| RP131H211B | U 2 1 B | 2.1V |
| RP131H221B | U 2 2 B | 2.2V |
| RP131H231B | U 2 3 B | 2.3V |
| RP131H241B | U 2 4 B | 2.4V |
| RP131H251B | U 2 5 B | 2.5V |
| RP131H261B | U 2 6 B | 2.6V |
| RP131H271B | U 2 7 B | 2.7V |
| RP131H281B | U 2 8 B | 2.8V |
| RP131H291B | U 2 9 B | 2.9V |
| RP131H301B | U 3 0 B | 3.0V |
| RP131H311B | U 3 1 B | 3.1V |
| RP131H321B | U 3 2 B | 3.2V |
| RP131H331B | U 3 3 B | 3.3V |
| RP131H341B | U 3 4 B | 3.4V |
| RP131H351B | U 3 5 B | 3.5V |
| RP131H361B | U 3 6 B | 3.6V |
| RP131H371B | U 3 7 B | 3.7V |
| RP131H381B | U 3 8 B | 3.8V |
| RP131H391B | U 3 9 B | 3.9V |
| RP131H401B | U 4 0 B | 4.0V |
| RP131H411B | U 4 1 B | 4.1V |
| RP131H421B | U 4 2 B | 4.2V |
| RP131H431B | U 4 3 B | 4.3V |
| RP131H441B | U 4 4 B | 4.4V |
| RP131H451B | U 4 5 B | 4.5V |
| RP131H461B | U 4 6 B | 4.6V |
| RP131H471B | U 4 7 B | 4.7V |
| RP131H481B | U 4 8 B | 4.8V |
| RP131H491B | U 4 9 B | 4.9V |
| RP131H501B | U 5 0 B | 5.0V |
| RP131H511B | U 5 1 B | 5.1V |
| RP131H521B | U 5 2 B | 5.2V |
| RP131H531B | U 5 3 B | 5.3V |
| RP131H541B | U 5 4 B | 5.4V |
| RP131H551B | U 5 5 B | 5.5V |
| RP131H121B5 | U 0 1 B | 1.25V |
| RP131H181B5 | U 0 2 B | 1.85V |
| RP131H281B5 | U 0 3 B | 2.85V |
| RP131H101B5 | U 0 4 B | 1.05V |

RP131Hxx1D

| Part Number | ①②③④ | Vset |
|-------------|----------------|-------|
| RP131H081D | U 0 8 D | 0.8V |
| RP131H091D | U 0 9 D | 0.9V |
| RP131H101D | U 1 0 D | 1.0V |
| RP131H111D | U 1 1 D | 1.1V |
| RP131H121D | U 1 2 D | 1.2V |
| RP131H131D | U 1 3 D | 1.3V |
| RP131H141D | U 1 4 D | 1.4V |
| RP131H151D | U 1 5 D | 1.5V |
| RP131H161D | U 1 6 D | 1.6V |
| RP131H171D | U 1 7 D | 1.7V |
| RP131H181D | U 1 8 D | 1.8V |
| RP131H191D | U 1 9 D | 1.9V |
| RP131H201D | U 2 0 D | 2.0V |
| RP131H211D | U 2 1 D | 2.1V |
| RP131H221D | U 2 2 D | 2.2V |
| RP131H231D | U 2 3 D | 2.3V |
| RP131H241D | U 2 4 D | 2.4V |
| RP131H251D | U 2 5 D | 2.5V |
| RP131H261D | U 2 6 D | 2.6V |
| RP131H271D | U 2 7 D | 2.7V |
| RP131H281D | U 2 8 D | 2.8V |
| RP131H291D | U 2 9 D | 2.9V |
| RP131H301D | U 3 0 D | 3.0V |
| RP131H311D | U 3 1 D | 3.1V |
| RP131H321D | U 3 2 D | 3.2V |
| RP131H331D | U 3 3 D | 3.3V |
| RP131H341D | U 3 4 D | 3.4V |
| RP131H351D | U 3 5 D | 3.5V |
| RP131H361D | U 3 6 D | 3.6V |
| RP131H371D | U 3 7 D | 3.7V |
| RP131H381D | U 3 8 D | 3.8V |
| RP131H391D | U 3 9 D | 3.9V |
| RP131H401D | U 4 0 D | 4.0V |
| RP131H411D | U 4 1 D | 4.1V |
| RP131H421D | U 4 2 D | 4.2V |
| RP131H431D | U 4 3 D | 4.3V |
| RP131H441D | U 4 4 D | 4.4V |
| RP131H451D | U 4 5 D | 4.5V |
| RP131H461D | U 4 6 D | 4.6V |
| RP131H471D | U 4 7 D | 4.7V |
| RP131H481D | U 4 8 D | 4.8V |
| RP131H491D | U 4 9 D | 4.9V |
| RP131H501D | U 5 0 D | 5.0V |
| RP131H511D | U 5 1 D | 5.1V |
| RP131H521D | U 5 2 D | 5.2V |
| RP131H531D | U 5 3 D | 5.3V |
| RP131H541D | U 5 4 D | 5.4V |
| RP131H551D | U 5 5 D | 5.5V |
| RP131H121D5 | U 0 1 D | 1.25V |
| RP131H181D5 | U 0 2 D | 1.85V |
| RP131H281D5 | U 0 3 D | 2.85V |
| RP131H101D5 | U 0 4 D | 1.05V |

RP131x

NO.EA-174-160426

Power Dissipation (HSOP-6J)

This specification is at mounted on board. Power Dissipation (P_D) depends on conditions of mounting on board. This specification is based on the measurement at the condition below:

Measurement Conditions

| | High Wattage Land Pattern | Standard Land Pattern |
|------------------|--|--|
| Environment | Mounting on Board (Wind velocity=0m/s) | Mounting on Board (Wind velocity=0m/s) |
| Board Material | Glass cloth epoxy plastic (Double-sided) | Glass cloth epoxy plastic (Double-sided) |
| Board Dimensions | 50mm * 50mm * 1.6mm | 50mm * 50mm * 1.6mm |
| Copper Ratio | 90% | 50% |
| Through-hole | $\phi 0.5\text{mm} * 44\text{pcs}$ | $\phi 0.5\text{mm} * 44\text{pcs}$ |

Measurement Result

($T_a=25^\circ\text{C}$)

| | High Wattage Land Pattern | Standard Land Pattern | Free Air |
|--------------------|---------------------------|--|-----------------------|
| Power Dissipation | 2000mW | 1700mW ($T_{j\text{max}}=125^\circ\text{C}$) 2125mW ($T_{j\text{max}}=150^\circ\text{C}$) | 540mW |
| Thermal Resistance | 50°C/W | 59°C/W | 185°C/W |

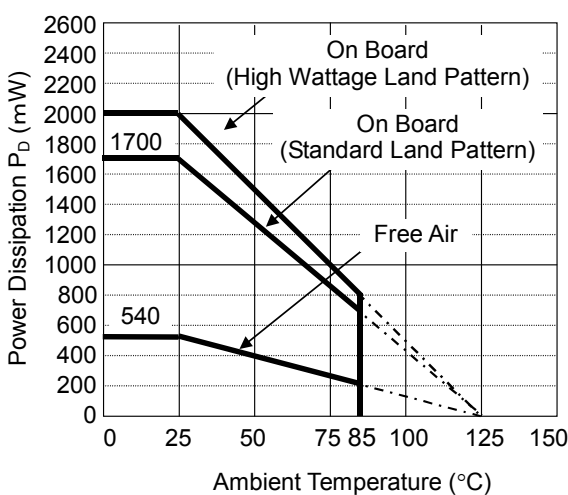

Power Dissipation



High Wattage

Standard

Measurement Board Pattern

○ IC Mount Area Unit: mm

- The above graph shows the Power Dissipation of the package based on $T_{j\text{max}}=125^\circ\text{C}$ and $T_{j\text{max}}=150^\circ\text{C}$. Operating the IC in the shaded area in the graph might have an influence its lifetime. Operating time must be within the time limit described in the table below, in case of operating in the shaded area.

| |
|----------------|
| Operating Time |
| 1,500 hours |

Package Dimensions (HSOP-6J)



Mark Specifications (HSOP-6J)

①②③④: Product Code ... Refer to RP131S Series Mark Specification Table.

⑤⑥: Lot Number ... Alphanumeric Serial Number



RP131S Series Mark Specification Table

PKG: HSOP-6J

RP131Sxx1B

| Part Number | ①②③④ | Vset |
|-------------|----------------|-------|
| RP131S081B | G 0 8 B | 0.8V |
| RP131S091B | G 0 9 B | 0.9V |
| RP131S101B | G 1 0 B | 1.0V |
| RP131S111B | G 1 1 B | 1.1V |
| RP131S121B | G 1 2 B | 1.2V |
| RP131S131B | G 1 3 B | 1.3V |
| RP131S141B | G 1 4 B | 1.4V |
| RP131S151B | G 1 5 B | 1.5V |
| RP131S161B | G 1 6 B | 1.6V |
| RP131S171B | G 1 7 B | 1.7V |
| RP131S181B | G 1 8 B | 1.8V |
| RP131S191B | G 1 9 B | 1.9V |
| RP131S201B | G 2 0 B | 2.0V |
| RP131S211B | G 2 1 B | 2.1V |
| RP131S221B | G 2 2 B | 2.2V |
| RP131S231B | G 2 3 B | 2.3V |
| RP131S241B | G 2 4 B | 2.4V |
| RP131S251B | G 2 5 B | 2.5V |
| RP131S261B | G 2 6 B | 2.6V |
| RP131S271B | G 2 7 B | 2.7V |
| RP131S281B | G 2 8 B | 2.8V |
| RP131S291B | G 2 9 B | 2.9V |
| RP131S301B | G 3 0 B | 3.0V |
| RP131S311B | G 3 1 B | 3.1V |
| RP131S321B | G 3 2 B | 3.2V |
| RP131S331B | G 3 3 B | 3.3V |
| RP131S341B | G 3 4 B | 3.4V |
| RP131S351B | G 3 5 B | 3.5V |
| RP131S361B | G 3 6 B | 3.6V |
| RP131S371B | G 3 7 B | 3.7V |
| RP131S381B | G 3 8 B | 3.8V |
| RP131S391B | G 3 9 B | 3.9V |
| RP131S401B | G 4 0 B | 4.0V |
| RP131S411B | G 4 1 B | 4.1V |
| RP131S421B | G 4 2 B | 4.2V |
| RP131S431B | G 4 3 B | 4.3V |
| RP131S441B | G 4 4 B | 4.4V |
| RP131S451B | G 4 5 B | 4.5V |
| RP131S461B | G 4 6 B | 4.6V |
| RP131S471B | G 4 7 B | 4.7V |
| RP131S481B | G 4 8 B | 4.8V |
| RP131S491B | G 4 9 B | 4.9V |
| RP131S501B | G 5 0 B | 5.0V |
| RP131S511B | G 5 1 B | 5.1V |
| RP131S521B | G 5 2 B | 5.2V |
| RP131S531B | G 5 3 B | 5.3V |
| RP131S541B | G 5 4 B | 5.4V |
| RP131S551B | G 5 5 B | 5.5V |
| RP131S121B5 | G 0 1 B | 1.25V |
| RP131S181B5 | G 0 2 B | 1.85V |
| RP131S281B5 | G 0 3 B | 2.85V |
| RP131S101B5 | G 0 4 B | 1.05V |

RP131Sxx1D

| Part Number | ①②③④ | Vset |
|-------------|----------------|-------|
| RP131S081D | G 0 8 D | 0.8V |
| RP131S091D | G 0 9 D | 0.9V |
| RP131S101D | G 1 0 D | 1.0V |
| RP131S111D | G 1 1 D | 1.1V |
| RP131S121D | G 1 2 D | 1.2V |
| RP131S131D | G 1 3 D | 1.3V |
| RP131S141D | G 1 4 D | 1.4V |
| RP131S151D | G 1 5 D | 1.5V |
| RP131S161D | G 1 6 D | 1.6V |
| RP131S171D | G 1 7 D | 1.7V |
| RP131S181D | G 1 8 D | 1.8V |
| RP131S191D | G 1 9 D | 1.9V |
| RP131S201D | G 2 0 D | 2.0V |
| RP131S211D | G 2 1 D | 2.1V |
| RP131S221D | G 2 2 D | 2.2V |
| RP131S231D | G 2 3 D | 2.3V |
| RP131S241D | G 2 4 D | 2.4V |
| RP131S251D | G 2 5 D | 2.5V |
| RP131S261D | G 2 6 D | 2.6V |
| RP131S271D | G 2 7 D | 2.7V |
| RP131S281D | G 2 8 D | 2.8V |
| RP131S291D | G 2 9 D | 2.9V |
| RP131S301D | G 3 0 D | 3.0V |
| RP131S311D | G 3 1 D | 3.1V |
| RP131S321D | G 3 2 D | 3.2V |
| RP131S331D | G 3 3 D | 3.3V |
| RP131S341D | G 3 4 D | 3.4V |
| RP131S351D | G 3 5 D | 3.5V |
| RP131S361D | G 3 6 D | 3.6V |
| RP131S371D | G 3 7 D | 3.7V |
| RP131S381D | G 3 8 D | 3.8V |
| RP131S391D | G 3 9 D | 3.9V |
| RP131S401D | G 4 0 D | 4.0V |
| RP131S411D | G 4 1 D | 4.1V |
| RP131S421D | G 4 2 D | 4.2V |
| RP131S431D | G 4 3 D | 4.3V |
| RP131S441D | G 4 4 D | 4.4V |
| RP131S451D | G 4 5 D | 4.5V |
| RP131S461D | G 4 6 D | 4.6V |
| RP131S471D | G 4 7 D | 4.7V |
| RP131S481D | G 4 8 D | 4.8V |
| RP131S491D | G 4 9 D | 4.9V |
| RP131S501D | G 5 0 D | 5.0V |
| RP131S511D | G 5 1 D | 5.1V |
| RP131S521D | G 5 2 D | 5.2V |
| RP131S531D | G 5 3 D | 5.3V |
| RP131S541D | G 5 4 D | 5.4V |
| RP131S551D | G 5 5 D | 5.5V |
| RP131S121D5 | G 0 1 D | 1.25V |
| RP131S181D5 | G 0 2 D | 1.85V |
| RP131S281D5 | G 0 3 D | 2.85V |
| RP131S101D5 | G 0 4 D | 1.05V |

Power Dissipation (TO-252-5-P2)

This specification is at mounted on board. Power Dissipation (P_D) depends on conditions of mounting on board. This specification is based on the measurement at the condition below:

Measurement conditions

| | Land Pattern A | Land Pattern B |
|------------------|--|--|
| Environment | Mounting on board (Wind velocity 0m/s) | Mounting on board (Wind velocity 0m/s) |
| Board Material | Glass cloth epoxy plastic (Double-layers) | Glass cloth epoxy plastic (Four-layers) |
| Board Dimensions | 50mm * 50mm * 1.6mm | 76.2mm * 114.3mm * 0.8mm |
| Copper Ratio | Top side: Approx. 50%, Back side: Approx. 50% | Top, Back side: Approx. 96%, 2nd, 3rd: 100% |
| Through - hole | ϕ 0.5mm * 24pcs | ϕ 0.4mm * 30pcs |

Measurement Results

($T_a=25^\circ\text{C}$)

| | Land pattern A | Land pattern B |
|--------------------|---|--|
| Power Dissipation | 1900mW ($T_{jmax}=125^\circ\text{C}$) 2375mW ($T_{jmax}=150^\circ\text{C}$) | 3800mW ($T_{jmax}=125^\circ\text{C}$) 4750mW ($T_{jmax}=150^\circ\text{C}$) |
| Thermal Resistance | $\theta_{ja}=(125-25^\circ\text{C})/1.9\text{W}= 53^\circ\text{C/W}$ $\theta_{jc}= 17^\circ\text{C/W}$ | $\theta_{ja}= (125-25^\circ\text{C})/3.8\text{W} = 26^\circ\text{C/W}$ $\theta_{jc}= 7^\circ\text{C/W}$ |



- The above graph shows the Power Dissipation of the package based on $T_{jmax}=125^\circ\text{C}$ and $T_{jmax}=150^\circ\text{C}$. Operating the IC in the shaded area in the graph might have an influence it's lifetime. Operating time must be within the time limit described in the table below, in case of operating in the shaded area.

| Operating Time | Estimated years (Operating four hours/day) |
|----------------|---|
| 13,000 hours | 9years |

Measurent Board Pattern
 IC Mount Area Unit : mm

Measurent Board Pattern
 IC Mount Area Unit : mm

RP131x

NO.EA-174-160426

Package Dimensions (TO-252-5-P2)

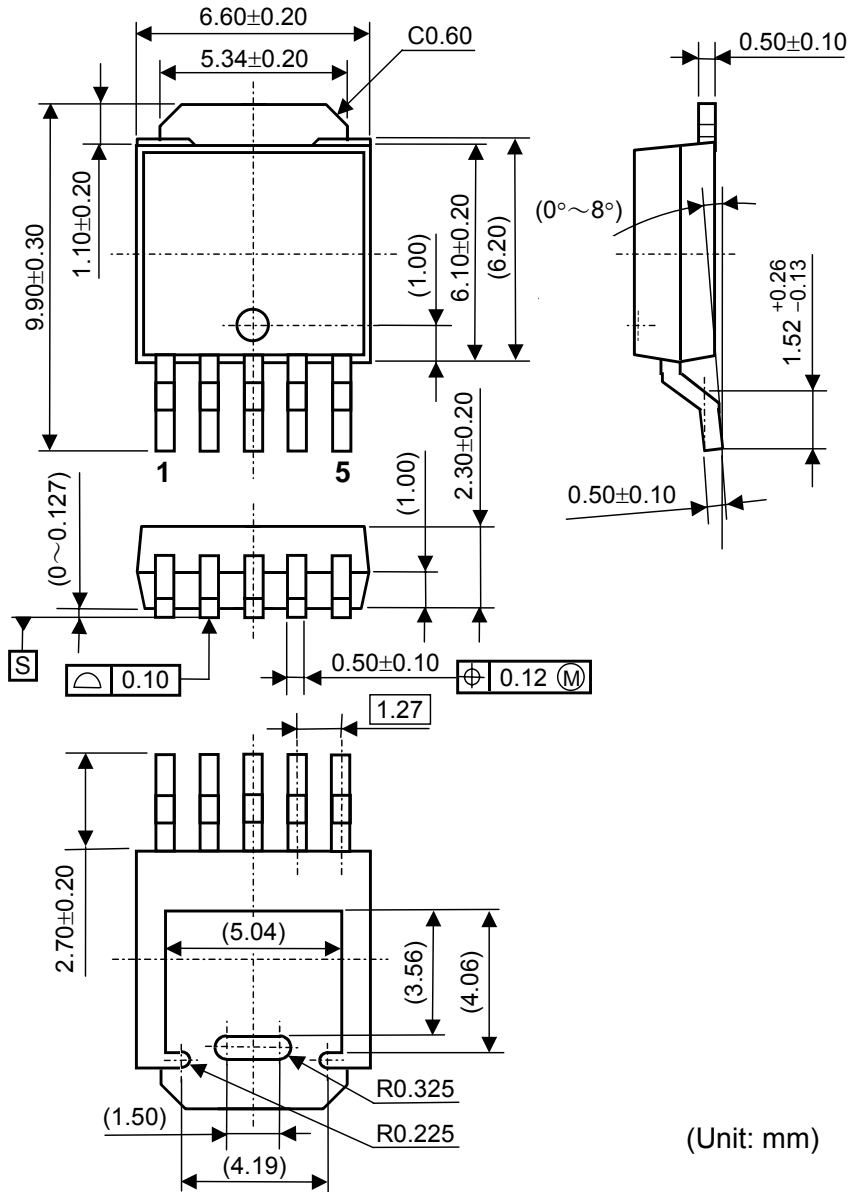

(Unit: mm)

Mark Specifications (TO-252-5-P2)

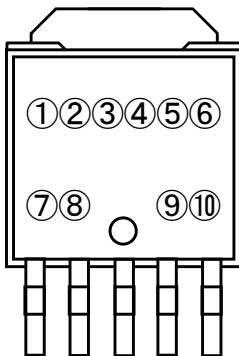

①②③④⑤⑥⑦⑧: Refer to RP131J Series Mark Specification Table.

⑨⑩: Lot Number ... Alphanumeric Serial Number

RP131J Series Mark Specification Table

PKG: TO-252-5

RP131Jxx1B

| Part Number | ①②③④⑤⑥⑦⑧ | Vset |
|-------------|-----------------|-------|
| RP131J081B | D 1 J 0 8 1 B | 0.8V |
| RP131J091B | D 1 J 0 9 1 B | 0.9V |
| RP131J101B | D 1 J 1 0 1 B | 1.0V |
| RP131J111B | D 1 J 1 1 1 B | 1.1V |
| RP131J121B | D 1 J 1 2 1 B | 1.2V |
| RP131J131B | D 1 J 1 3 1 B | 1.3V |
| RP131J141B | D 1 J 1 4 1 B | 1.4V |
| RP131J151B | D 1 J 1 5 1 B | 1.5V |
| RP131J161B | D 1 J 1 6 1 B | 1.6V |
| RP131J171B | D 1 J 1 7 1 B | 1.7V |
| RP131J181B | D 1 J 1 8 1 B | 1.8V |
| RP131J191B | D 1 J 1 9 1 B | 1.9V |
| RP131J201B | D 1 J 2 0 1 B | 2.0V |
| RP131J211B | D 1 J 2 1 1 B | 2.1V |
| RP131J221B | D 1 J 2 2 1 B | 2.2V |
| RP131J231B | D 1 J 2 3 1 B | 2.3V |
| RP131J241B | D 1 J 2 4 1 B | 2.4V |
| RP131J251B | D 1 J 2 5 1 B | 2.5V |
| RP131J261B | D 1 J 2 6 1 B | 2.6V |
| RP131J271B | D 1 J 2 7 1 B | 2.7V |
| RP131J281B | D 1 J 2 8 1 B | 2.8V |
| RP131J291B | D 1 J 2 9 1 B | 2.9V |
| RP131J301B | D 1 J 3 0 1 B | 3.0V |
| RP131J311B | D 1 J 3 1 1 B | 3.1V |
| RP131J321B | D 1 J 3 2 1 B | 3.2V |
| RP131J331B | D 1 J 3 3 1 B | 3.3V |
| RP131J341B | D 1 J 3 4 1 B | 3.4V |
| RP131J351B | D 1 J 3 5 1 B | 3.5V |
| RP131J361B | D 1 J 3 6 1 B | 3.6V |
| RP131J371B | D 1 J 3 7 1 B | 3.7V |
| RP131J381B | D 1 J 3 8 1 B | 3.8V |
| RP131J391B | D 1 J 3 9 1 B | 3.9V |
| RP131J401B | D 1 J 4 0 1 B | 4.0V |
| RP131J411B | D 1 J 4 1 1 B | 4.1V |
| RP131J421B | D 1 J 4 2 1 B | 4.2V |
| RP131J431B | D 1 J 4 3 1 B | 4.3V |
| RP131J441B | D 1 J 4 4 1 B | 4.4V |
| RP131J451B | D 1 J 4 5 1 B | 4.5V |
| RP131J461B | D 1 J 4 6 1 B | 4.6V |
| RP131J471B | D 1 J 4 7 1 B | 4.7V |
| RP131J481B | D 1 J 4 8 1 B | 4.8V |
| RP131J491B | D 1 J 4 9 1 B | 4.9V |
| RP131J501B | D 1 J 5 0 1 B | 5.0V |
| RP131J511B | D 1 J 5 1 1 B | 5.1V |
| RP131J521B | D 1 J 5 2 1 B | 5.2V |
| RP131J531B | D 1 J 5 3 1 B | 5.3V |
| RP131J541B | D 1 J 5 4 1 B | 5.4V |
| RP131J551B | D 1 J 5 5 1 B | 5.5V |
| RP131J121B5 | D 1 J 1 2 1 B 5 | 1.25V |
| RP131J181B5 | D 1 J 1 8 1 B 5 | 1.85V |
| RP131J281B5 | D 1 J 2 8 1 B 5 | 2.85V |
| RP131J101B5 | D 1 J 1 0 1 B 5 | 1.05V |

RP131Jxx1D

| Part Number | ①②③④⑤⑥⑦⑧ | Vset |
|-------------|-----------------|-------|
| RP131J081D | D 1 J 0 8 1 D | 0.8V |
| RP131J091D | D 1 J 0 9 1 D | 0.9V |
| RP131J101D | D 1 J 1 0 1 D | 1.0V |
| RP131J111D | D 1 J 1 1 1 D | 1.1V |
| RP131J121D | D 1 J 1 2 1 D | 1.2V |
| RP131J131D | D 1 J 1 3 1 D | 1.3V |
| RP131J141D | D 1 J 1 4 1 D | 1.4V |
| RP131J151D | D 1 J 1 5 1 D | 1.5V |
| RP131J161D | D 1 J 1 6 1 D | 1.6V |
| RP131J171D | D 1 J 1 7 1 D | 1.7V |
| RP131J181D | D 1 J 1 8 1 D | 1.8V |
| RP131J191D | D 1 J 1 9 1 D | 1.9V |
| RP131J201D | D 1 J 2 0 1 D | 2.0V |
| RP131J211D | D 1 J 2 1 1 D | 2.1V |
| RP131J221D | D 1 J 2 2 1 D | 2.2V |
| RP131J231D | D 1 J 2 3 1 D | 2.3V |
| RP131J241D | D 1 J 2 4 1 D | 2.4V |
| RP131J251D | D 1 J 2 5 1 D | 2.5V |
| RP131J261D | D 1 J 2 6 1 D | 2.6V |
| RP131J271D | D 1 J 2 7 1 D | 2.7V |
| RP131J281D | D 1 J 2 8 1 D | 2.8V |
| RP131J291D | D 1 J 2 9 1 D | 2.9V |
| RP131J301D | D 1 J 3 0 1 D | 3.0V |
| RP131J311D | D 1 J 3 1 1 D | 3.1V |
| RP131J321D | D 1 J 3 2 1 D | 3.2V |
| RP131J331D | D 1 J 3 3 1 D | 3.3V |
| RP131J341D | D 1 J 3 4 1 D | 3.4V |
| RP131J351D | D 1 J 3 5 1 D | 3.5V |
| RP131J361D | D 1 J 3 6 1 D | 3.6V |
| RP131J371D | D 1 J 3 7 1 D | 3.7V |
| RP131J381D | D 1 J 3 8 1 D | 3.8V |
| RP131J391D | D 1 J 3 9 1 D | 3.9V |
| RP131J401D | D 1 J 4 0 1 D | 4.0V |
| RP131J411D | D 1 J 4 1 1 D | 4.1V |
| RP131J421D | D 1 J 4 2 1 D | 4.2V |
| RP131J431D | D 1 J 4 3 1 D | 4.3V |
| RP131J441D | D 1 J 4 4 1 D | 4.4V |
| RP131J451D | D 1 J 4 5 1 D | 4.5V |
| RP131J461D | D 1 J 4 6 1 D | 4.6V |
| RP131J471D | D 1 J 4 7 1 D | 4.7V |
| RP131J481D | D 1 J 4 8 1 D | 4.8V |
| RP131J491D | D 1 J 4 9 1 D | 4.9V |
| RP131J501D | D 1 J 5 0 1 D | 5.0V |
| RP131J511D | D 1 J 5 1 1 D | 5.1V |
| RP131J521D | D 1 J 5 2 1 D | 5.2V |
| RP131J531D | D 1 J 5 3 1 D | 5.3V |
| RP131J541D | D 1 J 5 4 1 D | 5.4V |
| RP131J551D | D 1 J 5 5 1 D | 5.5V |
| RP131J121D5 | D 1 J 1 2 1 D 5 | 1.25V |
| RP131J181D5 | D 1 J 1 8 1 D 5 | 1.85V |
| RP131J281D5 | D 1 J 2 8 1 D 5 | 2.85V |
| RP131J101D5 | D 1 J 1 0 1 D 5 | 1.05V |



1. The products and the product specifications described in this document are subject to change or discontinuation of production without notice for reasons such as improvement. Therefore, before deciding to use the products, please refer to Ricoh sales representatives for the latest information thereon.
2. The materials in this document may not be copied or otherwise reproduced in whole or in part without prior written consent of Ricoh.
3. Please be sure to take any necessary formalities under relevant laws or regulations before exporting or otherwise taking out of your country the products or the technical information described herein.
4. The technical information described in this document shows typical characteristics of and example application circuits for the products. The release of such information is not to be construed as a warranty of or a grant of license under Ricoh's or any third party's intellectual property rights or any other rights.
5. The products listed in this document are intended and designed for use as general electronic components in standard applications (office equipment, telecommunication equipment, measuring instruments, consumer electronic products, amusement equipment etc.). Those customers intending to use a product in an application requiring extreme quality and reliability, for example, in a highly specific application where the failure or misoperation of the product could result in human injury or death (aircraft, spacevehicle, nuclear reactor control system, traffic control system, automotive and transportation equipment, combustion equipment, safety devices, life support system etc.) should first contact us.
6. We are making our continuous effort to improve the quality and reliability of our products, but semiconductor products are likely to fail with certain probability. In order to prevent any injury to persons or damages to property resulting from such failure, customers should be careful enough to incorporate safety measures in their design, such as redundancy feature, fire containment feature and fail-safe feature. We do not assume any liability or responsibility for any loss or damage arising from misuse or inappropriate use of the products.
7. Anti-radiation design is not implemented in the products described in this document.
8. Please contact Ricoh sales representatives should you have any questions or comments concerning the products or the technical information.



Ricoh is committed to reducing the environmental loading materials in electrical devices with a view to contributing to the protection of human health and the environment.

Ricoh has been providing RoHS compliant products since April 1, 2006 and Halogen-free products since April 1, 2012.

RICOH RICOH ELECTRONIC DEVICES CO., LTD.

<http://www.e-devices.ricoh.co.jp/en/>

Sales & Support Offices

RICOH ELECTRONIC DEVICES CO., LTD.

Higashi-Shinagawa Office (International Sales)
3-32-3, Higashi-Shinagawa, Shinagawa-ku, Tokyo 140-8655, Japan
Phone: +81-3-5479-2857 Fax: +81-3-5479-0502

RICOH EUROPE (NETHERLANDS) B.V.

Semiconductor Support Centre
Prof. W.H. Keesomlaan 1, 1183 DJ Amstelveen, The Netherlands
Phone: +31-20-5474-309

RICOH INTERNATIONAL B.V. - German Branch

Semiconductor Sales and Support Centre
Oberrather Strasse 6, 40472 Düsseldorf, Germany
Phone: +49-211-6546-0

RICOH ELECTRONIC DEVICES KOREA CO., LTD.

3F, Haesung Bldg, 504, Teheran-ro, Gangnam-gu, Seoul, 135-725, Korea
Phone: +82-2-2135-5700 Fax: +82-2-2051-5713

RICOH ELECTRONIC DEVICES SHANGHAI CO., LTD.

Room 403, No.2 Building, No.690 Bibo Road, Pu Dong New District, Shanghai 201203,
People's Republic of China
Phone: +86-21-5027-3200 Fax: +86-21-5027-3299

RICOH ELECTRONIC DEVICES CO., LTD.

Taipei office
Room 109, 10F-1, No.51, Hengyang Rd., Taipei City, Taiwan (R.O.C.)
Phone: +886-2-2313-1621/1622 Fax: +886-2-2313-1623

Mouser Electronics

Authorized Distributor

Click to View Pricing, Inventory, Delivery & Lifecycle Information:

Ricoh Electronics:

[RP131H101D-T1-FE](#) [RP131S331D-E2-FE](#) [RP131S331B-E2-FE](#) [RP131H181D-T1-FE](#) [RP131H181B-T1-FE](#)
[RP131H501B-T1-FE](#) [RP131S151B-E2-FE](#) [RP131S101B-E2-FE](#) [RP131S301D-E2-FE](#) [RP131J151D-T1-FE](#)
[RP131H451D-T1-FE](#) [RP131H251B-T1-FE](#) [RP131S281D-E2-FE](#) [RP131S251D-E2-FE](#) [RP131S151D-E2-FE](#)
[RP131J121D-T1-FE](#) [RP131H251D-T1-FE](#) [RP131S501D-E2-FE](#) [RP131S451D-E2-FE](#) [RP131H151D-T1-FE](#)
[RP131H331B-T1-FE](#) [RP131H121D-T1-FE](#) [RP131S101D-E2-FE](#) [RP131S121B-E2-FE](#) [RP131H121B-T1-FE](#)
[RP131H301D-T1-FE](#) [RP131S121D-E2-FE](#) [RP131H151B-T1-FE](#) [RP131H501D-T1-FE](#) [RP131H331D-T1-FE](#)
[RP131S501B-E2-FE](#) [RP131S181B-E2-FE](#) [RP131S251B-E2-FE](#) [RP131S181D-E2-FE](#)



Компания «ЭлектроПласт» предлагает заключение долгосрочных отношений при поставках импортных электронных компонентов на взаимовыгодных условиях!

Наши преимущества:

- Оперативные поставки широкого спектра электронных компонентов отечественного и импортного производства напрямую от производителей и с крупнейших мировых складов;
- Поставка более 17-ти миллионов наименований электронных компонентов;
- Поставка сложных, дефицитных, либо снятых с производства позиций;
- Оперативные сроки поставки под заказ (от 5 рабочих дней);
- Экспресс доставка в любую точку России;
- Техническая поддержка проекта, помощь в подборе аналогов, поставка прототипов;
- Система менеджмента качества сертифицирована по Международному стандарту ISO 9001;
- Лицензия ФСБ на осуществление работ с использованием сведений, составляющих государственную тайну;
- Поставка специализированных компонентов (Xilinx, Altera, Analog Devices, Intersil, Interpoint, Microsemi, Aeroflex, Peregrine, Syfer, Eurofarad, Texas Instrument, Miteq, Cobham, E2V, MA-COM, Hittite, Mini-Circuits, General Dynamics и др.);

Помимо этого, одним из направлений компании «ЭлектроПласт» является направление «Источники питания». Мы предлагаем Вам помощь Конструкторского отдела:

- Подбор оптимального решения, техническое обоснование при выборе компонента;
- Подбор аналогов;
- Консультации по применению компонента;
- Поставка образцов и прототипов;
- Техническая поддержка проекта;
- Защита от снятия компонента с производства.



Как с нами связаться

Телефон: 8 (812) 309 58 32 (многоканальный)

Факс: 8 (812) 320-02-42

Электронная почта: org@eplast1.ru

Адрес: 198099, г. Санкт-Петербург, ул. Калинина, дом 2, корпус 4, литера А.