

## LOW ON RESISTANCE / LOW VOLTAGE 1A LDO

NO.EA-174-160426

### OUTLINE

The RP131x Series are voltage-regulators with a built-in low ON-resistance transistor and output current is 1A capability. These ICs are capable of the low input voltage (Min.1.6V) and also the minimum output voltage can be set from 0.8V. (The output voltage is fixed in the IC.)

Each of these ICs consists of a voltage reference unit, an error amplifier, a resistor net for setting output voltage, a chip enable circuit, current limit circuits for over-current and short, and a thermal-shutdown circuit.

A standby mode with ultra low supply current can be realized with the chip enable function.

The packages for these ICs are DFN1616-6B and DFN(PLP)1820-6 which are suitable for high density mounting of the ICs on boards. SOT-89-5, HSOP-6J and TO-252-5-P2 with high power dissipation are also available.

### FEATURES

- Output Current ..... Min. 1A
- Supply Current ..... Typ. 65 $\mu$ A
- Standby Current ..... Typ. 0.15 $\mu$ A
- Input Voltage Range ..... 1.6V to 6.5V
- Output Voltage Range ..... 0.8V to 5.5V (0.1V steps)  
(For other voltages, please refer to MARK INFORMATIONS.)
- Dropout Voltage..... Typ. 0.5V ( $V_{OUT}=2.8V$ ,  $I_{OUT}=1A$ )
- Ripple Rejection ..... Typ. 70dB ( $f=1kHz$ ,  $V_{OUT}=2.8V$ )
- Output Voltage Accuracy .....  $\pm 1.0\%$
- Temperature-Drift Coefficient of Output Voltage ..... Typ.  $\pm 100ppm/^{\circ}C$
- Line Regulation ..... Typ. 0.05%/V
- Load Regulation ..... Typ. 20mV at  $I_{OUT}=300mA$ , Typ. 80mV at  $I_{OUT}=1A$
- Packages ..... DFN1616-6B, DFN(PLP)1820-6, SOT-89-5, HSOP-6J, TO-252-5-P2
- Built-in Inrush current limit circuit ..... Typ. 500mA
- Built-in Fold-Back Protection Circuit ..... Typ. 250mA (Current at short mode)
- Built-in Thermal Shutdown Circuit ..... Thermal Shutdown Temperature ; Typ. 165 $^{\circ}C$   
Released Temperature ; Typ. 135 $^{\circ}C$
- Built-in Auto Discharge Function ..... D version
- Ceramic capacitors are recommended to be used with this IC .... 2.2 $\mu$ F or more ( $V_{OUT}\leq 3.6V$ )  
4.7 $\mu$ F or more ( $V_{OUT}> 3.6V$ )

### APPLICATIONS

- Power source for battery-powered equipment.
- Power source for portable communication equipment.
- Power source for electrical appliances such as cameras, VCRs and camcorders.
- Power source for Notebook PC.
- Power source for home appliances.

# RP131x

NO.EA-174-160426

## BLOCK DIAGRAMS



## SELECTION GUIDE

The output voltage, auto discharge function, package for the ICs can be selected at the user's request.

Product Name	Package	Quantity per Reel	Pb Free	Halogen Free
RP131Lxx1*-TR	DFN1616-6B	5,000 pcs	Yes	Yes
RP131Kxx1*-TR	DFN(PLP)1820-6	5,000 pcs	Yes	Yes
RP131Hxx1*-T1-FE	SOT-89-5	1,000 pcs	Yes	Yes
RP131Sxx1*-E2-FE	HSOP-6J	1,000 pcs	Yes	Yes
RP131Jxx1*-T1-FE	TO-252-5-P2	3,000 pcs	Yes	Yes

xx : The output voltage can be designated in the range from 0.8V(08) to 5.5V(55) in 0.1V steps.  
(For other voltages, please refer to MARK INFORMATIONS.)

\* :  The auto discharge function at off state are options as follows.  
(B) without auto discharge function at off state  
(D) with auto discharge function at off state

## PIN CONFIGURATIONS

● DFN1616-6B



● DFN(PLP)1820-6



● SOT-89-5

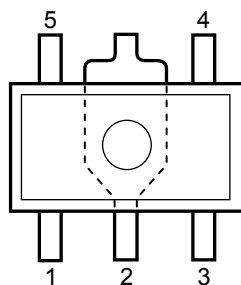

● HSOP-6J

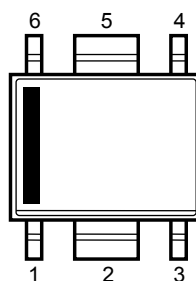

● TO-252-5-P2



## PIN DESCRIPTIONS

● DFN1616-6B

Pin No.	Symbol	Pin Description
1	$V_{OUT}$	Output Pin*2
2	$V_{OUT}$	Output Pin*2
3	GND	Ground Pin
4	CE	Chip Enable Pin ("H" Active)
5	$V_{DD}$	Input Pin*2
6	$V_{DD}$	Input Pin*2

\*1) Tab is GND level. (They are connected to the reverse side of this IC.)

The tab is better to be connected to the GND, but leaving it open is also acceptable.

\*2) When you use this IC, please make sure be wired with 1pin with 2pin and 5pin with 6pin.

---

**RP131x**

---

NO.EA-174-160426

**• DFN(PLP)1820-6**

Pin No.	Symbol	Pin Description
1	V <sub>OUT</sub>	Output Pin*2
2	V <sub>OUT</sub>	Output Pin*2
3	GND	Ground Pin
4	CE	Chip Enable Pin ("H" Active)
5	V <sub>DD</sub>	Input Pin*2
6	V <sub>DD</sub>	Input Pin*2

\*1) Tab is GND level. (They are connected to the reverse side of this IC.)

The tab is better to be connected to the GND, but leaving it open is also acceptable.

\*2) When you use this IC, please make sure be wired with 1pin with 2pin and 5pin with 6pin.

**• SOT-89-5**

Pin No.	Symbol	Pin Description
1	NC	No Connection
2	GND	Ground Pin
3	CE	Chip Enable Pin ("H" Active)
4	V <sub>DD</sub>	Input Pin
5	V <sub>OUT</sub>	Output Pin

**• HSOP-6J**

Pin No.	Symbol	Pin Description
1	V <sub>OUT</sub>	Output Pin
2	GND	Ground Pin*3
3	NC	No Connection
4	CE	Chip Enable Pin ("H" Active)
5	GND	Ground Pin*3
6	V <sub>DD</sub>	Input Pin

\*3) When you use this IC, please make sure be wired with 2pin and 5pin.

**• TO-252-5-P2**

Pin No.	Symbol	Pin Description
1	V <sub>OUT</sub>	Output Pin
2	GND	Ground Pin*4
3	GND	Ground Pin*4
4	CE	Chip Enable Pin ("H" Active)
5	V <sub>DD</sub>	Input Pin

\*4) When you use this IC, please make sure be wired with 2pin and 3pin.

## ABSOLUTE MAXIMUM RATINGS

Symbol	Item	Rating	Unit
V <sub>IN</sub>	Input Voltage	7.0	V
V <sub>CE</sub>	Input Voltage (CE Pin)	-0.3 to 7.0	V
V <sub>OUT</sub>	Output Voltage	-0.3 to V <sub>IN</sub> +0.3	V
P <sub>D</sub>	Power Dissipation (DFN1616-6B)*	640	mW
	Power Dissipation (DFN(PLP)1820-6)*	880	
	Power Dissipation (SOT-89-5)*	900	
	Power Dissipation (HSOP-6J)*	1700	
	Power Dissipation (TO-252-5-P2)*	1900	
T <sub>opt</sub>	Operating Temperature Range	-40 to 85	°C
T <sub>stg</sub>	Storage Temperature Range	-55 to 125	°C

\*) For Power Dissipation, please refer to PACKAGE INFORMATION.

### ABSOLUTE MAXIMUM RATINGS

Electronic and mechanical stress momentarily exceeded absolute maximum ratings may cause the permanent damages and may degrade the life time and safety for both device and system using the device in the field.

The functional operation at or over these absolute maximum ratings is not assured.

**RP131x**

NO.EA-174-160426

**ELECTRICAL CHARACTERISTICS** $V_{IN} = \text{Set } V_{OUT} + 1V, I_{OUT} = 1mA$ The specification in   is checked and guaranteed by design engineering at  $-40^{\circ}\text{C} \leq T_{opt} \leq 85^{\circ}\text{C}$ , unless otherwise noted.● **RP131xxx1B/D** $T_{opt} = 25^{\circ}\text{C}$ 

Symbol	Item	Conditions	Min.	Typ.	Max.	Unit	
$V_{OUT}$	Output Voltage	$T_{opt} = 25^{\circ}\text{C}$	$V_{OUT} > 1.5V$	$\times 0.99$		$\times 1.01$	V
			$V_{OUT} \leq 1.5V$	-15		15	mV
		$-40^{\circ}\text{C} \leq T_{opt} \leq 85^{\circ}\text{C}$	$V_{OUT} > 1.5V$	<span style="border: 1px solid black; padding: 0 2px;"><math>\times 0.974</math></span>		<span style="border: 1px solid black; padding: 0 2px;"><math>\times 1.018</math></span>	V
			$V_{OUT} \leq 1.5V$	<span style="border: 1px solid black; padding: 0 2px;">-40</span>		<span style="border: 1px solid black; padding: 0 2px;">27</span>	mV
$\frac{\Delta V_{OUT}}{\Delta I_{OUT}}$	Load Regulation	$0.1mA \leq I_{OUT} \leq 300mA$		20	<span style="border: 1px solid black; padding: 0 2px;">40</span>	mV	
		$0.1mA \leq I_{OUT} \leq 1A$		80	<span style="border: 1px solid black; padding: 0 2px;">120</span>		
$V_{DIF}$	Dropout Voltage	Refer to the following table					
$I_{SS}$	Supply Current	$I_{OUT} = 0mA$ ( $V_{IN} = 6.5V$ )		65	<span style="border: 1px solid black; padding: 0 2px;">90</span>	$\mu A$	
$I_{standby}$	Standby Current	$V_{CE} = 0V, V_{IN} = 6.5V$		0.15	0.60	$\mu A$	
$\frac{\Delta V_{OUT}}{\Delta V_{IN}}$	Line Regulation	Set $V_{OUT} + 0.5V \leq V_{IN} \leq 6.5V$ *However, $V_{IN} \geq 1.6V$		0.05	<span style="border: 1px solid black; padding: 0 2px;">0.1</span>	%/V	
RR	Ripple Rejection	$f = 1kHz$ Ripple 0.2Vp-p $I_{OUT} = 100mA$	$V_{OUT} \leq 3.3V$		70	dB	
			$V_{OUT} > 3.3V$		60		
$V_{IN}$	Input Voltage		<span style="border: 1px solid black; padding: 0 2px;">1.6</span>		<span style="border: 1px solid black; padding: 0 2px;">6.5</span>	V	
$\frac{\Delta V_{OUT}}{\Delta T_{opt}}$	Output Voltage Temperature Coefficient	$-40^{\circ}\text{C} \leq T_{opt} \leq 85^{\circ}\text{C}$		$\pm 100$		ppm/ $^{\circ}\text{C}$	
$I_{LIM}$	Output Current Limit		<span style="border: 1px solid black; padding: 0 2px;">1</span>			A	
$I_{SC}$	Short Current Limit	$V_{OUT} = 0V$		250		mA	
$I_{PD}$	CE Pull-down Current			0.3		$\mu A$	
$V_{CEH}$	CE Input Voltage "H"		<span style="border: 1px solid black; padding: 0 2px;">1.0</span>			V	
$V_{CEL}$	CE Input Voltage "L"				<span style="border: 1px solid black; padding: 0 2px;">0.4</span>	V	
$e_n$	Output Noise	$BW = 10Hz \text{ to } 100kHz, I_{OUT} = 1mA$		45		$\mu V_{rms}$	
$T_{TSD}$	Thermal Shutdown Temperature	Junction Temperature		165		$^{\circ}\text{C}$	
$T_{TSR}$	Thermal Shutdown Released Temperature	Junction Temperature		135		$^{\circ}\text{C}$	
$R_{LOW}$	Low Output Nch Tr. ON Resistance (of D version)	$V_{IN} = 4.0V, V_{CE} = 0V$		30		$\Omega$	

The specification in   is checked and guaranteed by design engineering at  $-40^{\circ}\text{C} \leq T_{opt} \leq 85^{\circ}\text{C}$ , unless otherwise noted.All of unit are tested and specified under load conditions such that  $T_j \approx T_{opt} = 25^{\circ}\text{C}$  except for Output Noise, Ripple Rejection, Output Voltage Temperature Coefficient, Dropout Voltage at 1A Output Current and Thermal Shutdown items.

• Dropout Voltage by Output Voltage

T<sub>opt</sub>=25°C

Output Voltage V <sub>OUT</sub> (V)	Dropout Voltage V <sub>DIF</sub> (V)					
	Condition	Typ.	Max.	Condition	Typ.	Max.
0.8 ≤ V <sub>OUT</sub> < 0.9	I <sub>OUT</sub> =300mA	0.600	0.780	I <sub>OUT</sub> =1A	1.100	1.650
0.9 ≤ V <sub>OUT</sub> < 1.0		0.550	0.690		1.050	1.500
1.0 ≤ V <sub>OUT</sub> < 1.1		0.450	0.610		1.000	1.450
1.1 ≤ V <sub>OUT</sub> < 1.2		0.340	0.540		0.930	1.420
1.2 ≤ V <sub>OUT</sub> < 1.5		0.290	0.500		0.900	1.380
1.5 ≤ V <sub>OUT</sub> < 2.6		0.230	0.310		0.700	1.100
2.6 ≤ V <sub>OUT</sub> < 3.3		0.150	0.180		0.500	0.750
3.3 ≤ V <sub>OUT</sub> ≤ 5.5		0.140	0.170		0.450	0.650

The specification in  is checked and guaranteed by design engineering at -40°C ≤ T<sub>opt</sub> ≤ 85°C, unless otherwise noted.

All of unit are tested and specified under load conditions such that T<sub>j</sub> ≈ T<sub>opt</sub> = 25°C except for Output Noise, Ripple Rejection, Output Voltage Temperature Coefficient, Dropout Voltage at 1A Output Current and Thermal Shutdown items.

**RECOMMENDED OPERATING CONDITIONS (ELECTRICAL CHARACTERISTICS)**

All of electronic equipment should be designed that the mounted semiconductor devices operate within the recommended operating conditions. The semiconductor devices cannot operate normally over the recommended operating conditions, even if when they are used over such conditions by momentary electronic noise or surge.

And the semiconductor devices may receive serious damage when they continue to operate over the recommended operating conditions.

## TYPICAL APPLICATION



Recommendation value of the external capacitors

$V_{OUT}$	Capacitors	
$V_{OUT} \leq 3.6V$	C1	Kyocera 2.2 $\mu$ F (size:1005) [CM05X5R225M06AB]
	C2	Kyocera 2.2 $\mu$ F (size:1608) [CM105X5R225K06AB]
$V_{OUT} > 3.6V$	C1	Kyocera 2.2 $\mu$ F (size:1608) [CM105X5R225K06AB]
	C2	Kyocera 4.7 $\mu$ F (size:1608) [CM105X5R475M06AB]

## TECHNICAL NOTES

When using these ICs, consider the following points:

### Phase Compensation

In these ICs, phase compensation is made for securing stable operation even if the load current is varied. For this purpose, use a capacitor C2 with good frequency characteristics and ESR (Equivalent Series Resistance).

If a tantalum capacitor is used, and its ESR of C2 is large, the loop oscillation may result. Because of this, select C2 carefully considering its frequency characteristics.

### PCB Layout

Make  $V_{DD}$  and GND lines sufficient. If their impedance is high, noise pickup or unstable operation may result. Connect a capacitor C1 between  $V_{DD}$  and GND pin with a capacitance value as "Recommendation value of the external capacitors" above or more, and as close as possible to the pins.

Set external components, especially the output capacitor C2, as close as possible to the ICs, and make wiring as short as possible.



## TEST CIRCUITS



**Basic Test Circuit**



**Test Circuit for Supply Current**



**Test Circuit for Ripple Rejection**



**Test Circuit for Load Transient Response**

**TYPICAL CHARACTERISTICS**

**1) Output Voltage vs. Output Current (T<sub>opt</sub>=25°C)**



**2) Output Voltage vs. Input Voltage (T<sub>opt</sub>=25°C)**





**3) Supply Current vs. Input Voltage (Topt=25°C)**

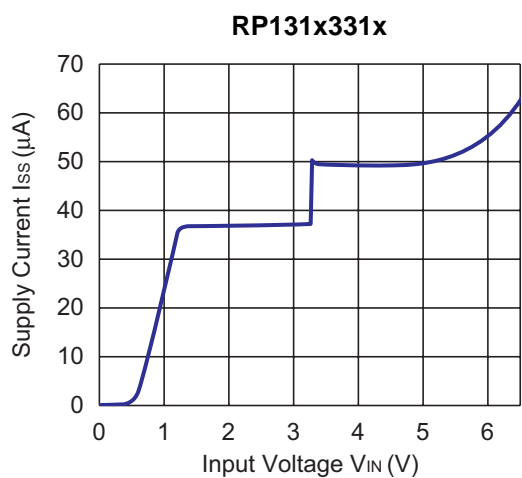

---

**RP131x**NO.EA-174-160426

---

**4) Output Voltage vs. Temperature****5) Supply Current vs. Temperature**

RP131x331x



RP131x501x



6) Dropout Voltage vs. Output Current

RP131x081x



RP131x151x



RP131x331x



RP131x501x



# RP131x

NO.EA-174-160426

## 7) Dropout Voltage vs. Set Output Voltage



## 8) Ripple Rejection vs. Input Bias Voltage ( $C1=none$ , $C2=Ceramic\ 1.0\mu F$ , $Ripple=0.2V_{pp}$ , $T_{opt}=25^{\circ}C$ )





9) Ripple Rejection vs. Frequency ( $C1=\text{none}$ ,  $C2=\text{Ceramic } 4.7\mu\text{F}$ ,  $T_{opt}=25^\circ\text{C}$ )



# RP131x

NO.EA-174-160426

## 10) Input Transient Response ( $I_{OUT}=100\text{mA}$ , $t_r=t_f=5\mu\text{s}$ , $C_1=\text{none}$ , $T_{opt}=25^\circ\text{C}$ )

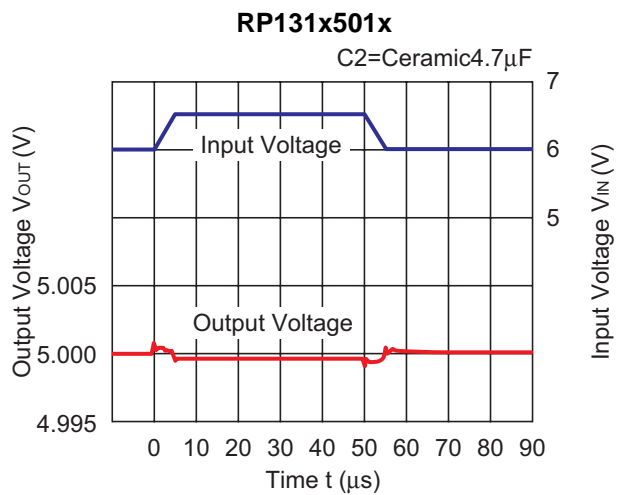
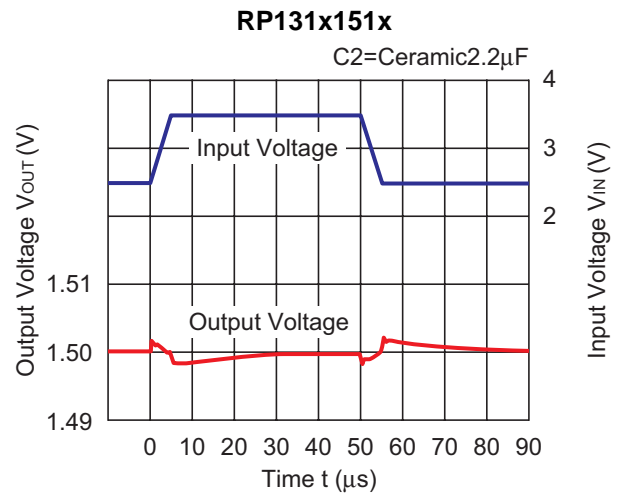

## 11) Load Transient Response ( $t_r=t_f=0.5\mu\text{s}$ , $C_1=\text{Ceramic } 2.2\mu\text{F}$ , $V_{IN}=V_{OUT}+1.0\text{V}$ , $T_{opt}=25^\circ\text{C}$ )

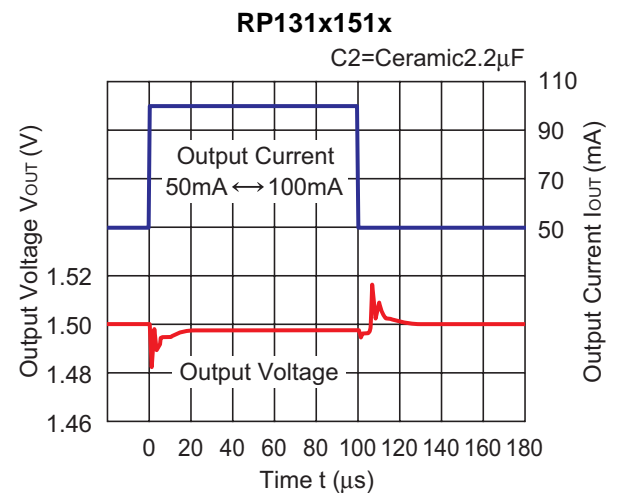



**RP131x331x**

C2=Ceramic4.7 $\mu$ F



**RP131x501x**

C2=Ceramic4.7 $\mu$ F



**RP131x081x**

C2=Ceramic2.2 $\mu$ F



**RP131x151x**

C2=Ceramic2.2 $\mu$ F



**RP131x331x**

C2=Ceramic4.7 $\mu$ F



**RP131x501x**

C2=Ceramic4.7 $\mu$ F



# RP131x

NO.EA-174-160426

### RP131x081x



### RP131x151x



### RP131x331x



### RP131x501x



## 12) Turn On Speed with CE pin (C1=Ceramic 2.2 $\mu$ F, C2=Ceramic 4.7 $\mu$ F, T<sub>opt</sub>=25 $^{\circ}$ C)

### RP131x081x



### RP131x501x



13) Turn Off Speed with CE pin (D Version) (C1=Ceramic 2.2μF, C2=Ceramic 4.7μF, T<sub>opt</sub>=25°C)



14) Inrush Current at turning on (C1=Ceramic 2.2μF, C2=Ceramic 4.7μF, T<sub>opt</sub>=25°C)



15) Minimum Operating Voltage



Hatched area is available for 0.8V output.

## RP131x

NO.EA-174-160426

### ESR vs. Output Current

When using these ICs, consider the following points:

The relations between  $I_{OUT}$  (Output Current) and ESR of an output capacitor are shown below.

The conditions when the white noise level is under  $40\mu\text{V}$  (Avg.) are marked as the hatched area in the graph.

#### Measurement conditions

Frequency Band : 10Hz to 3MHz

Temperature :  $-40^{\circ}\text{C}$  to  $85^{\circ}\text{C}$

C1 :  $2.2\mu\text{F}$  (Kyocera, CM05X5R225M04AD)

C2 :  $2.2\mu\text{F}$  (Kyocera, CM105X5R225K06AE)

$4.7\mu\text{F}$  (Kyocera, CM105X5R475M06AB)



## PACKAGE INFORMATION

### Power Dissipation (DFN1616-6B)

This specification is at mounted on board. Power Dissipation ( $P_D$ ) depends on conditions of mounting on board. This specification is based on the measurement at the condition below:

\* Measurement Conditions

	Standard Test Land Pattern
Environment	Mounting on Board (Wind velocity=0m/s)
Board Material	Glass cloth epoxy plastic (Double-sided)
Board Dimensions	40mm*40mm*1.6mm
Copper Ratio	Top side: Approx. 50%, Back side: Approx. 50%
Through-holes	$\phi$ 0.5mm * 32pcs

Measurement Result

( $T_a=25^\circ\text{C}$ )

	Standard Test Land Pattern
Power Dissipation	640mW ( $T_{jmax}=125^\circ\text{C}$ ) 820mW ( $T_{jmax}=150^\circ\text{C}$ )
Thermal Resistance	$\theta_{ja} = (125-25^\circ\text{C})/0.64\text{W} = 156^\circ\text{C/W}$ $\theta_{jc} = 23^\circ\text{C/W}$



**Power Dissipation**



**Measurement Board Pattern**

IC Mount Area (Unit: mm)

The above graph shows the Power Dissipation of the package based on  $T_{jmax}=125^\circ\text{C}$  and  $T_{jmax}=150^\circ\text{C}$ . Operating the IC in the shaded area in the graph might have an influence it's lifetime. Operating time must be within the time limit described in the table below, in case of operating in the shaded area.

Operating Time	Estimated years (Operating four hours/day)
13,000 hours	9years

**RP131x**

NO.EA-174-160426

**Package Dimensions (DFN1616-6B)**

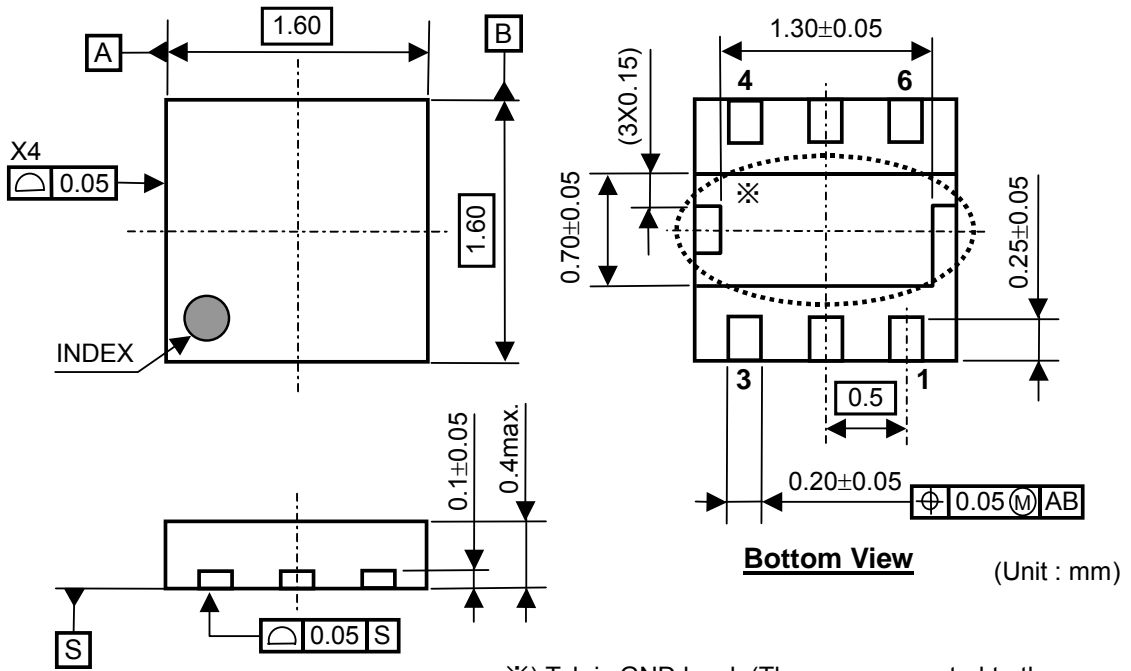

※) Tab is GND level. (They are connected to the reverse side of this IC.)  
The tab is better to be connected to the GND, but leaving it open is also acceptable.

**Mark Specifications (DFN1616-6B)**



①②③④: Product Code ... Refer to RP131L Series Mark Specification Table.

⑤⑥: Lot Number ... Alphanumeric Serial Number

## RP131L Series Mark Specification Table

PKG: DFN1616-6B

### RP131Lxx1B

Part Number	①②③④	Vset
RP131L081B	<b>CB 01</b>	0.8V
RP131L091B	<b>CB 02</b>	0.9V
RP131L101B	<b>CB 03</b>	1.0V
RP131L111B	<b>CB 04</b>	1.1V
RP131L121B	<b>CB 05</b>	1.2V
RP131L121B5	<b>CB 06</b>	1.25V
RP131L131B	<b>CB 07</b>	1.3V
RP131L141B	<b>CB 08</b>	1.4V
RP131L151B	<b>CB 09</b>	1.5V
RP131L161B	<b>CB 10</b>	1.6V
RP131L171B	<b>CB 11</b>	1.7V
RP131L181B	<b>CB 12</b>	1.8V
RP131L181B5	<b>CB 13</b>	1.85V
RP131L191B	<b>CB 14</b>	1.9V
RP131L201B	<b>CB 15</b>	2.0V
RP131L211B	<b>CB 16</b>	2.1V
RP131L221B	<b>CB 17</b>	2.2V
RP131L231B	<b>CB 18</b>	2.3V
RP131L241B	<b>CB 19</b>	2.4V
RP131L251B	<b>CB 20</b>	2.5V
RP131L261B	<b>CB 21</b>	2.6V
RP131L271B	<b>CB 22</b>	2.7V
RP131L281B	<b>CB 23</b>	2.8V
RP131L281B5	<b>CB 24</b>	2.85V
RP131L291B	<b>CB 25</b>	2.9V
RP131L301B	<b>CB 26</b>	3.0V
RP131L311B	<b>CB 27</b>	3.1V
RP131L321B	<b>CB 28</b>	3.2V
RP131L331B	<b>CB 29</b>	3.3V
RP131L341B	<b>CB 30</b>	3.4V
RP131L351B	<b>CB 31</b>	3.5V
RP131L361B	<b>CB 32</b>	3.6V
RP131L371B	<b>CB 33</b>	3.7V
RP131L381B	<b>CB 34</b>	3.8V
RP131L391B	<b>CB 35</b>	3.9V
RP131L401B	<b>CB 36</b>	4.0V
RP131L411B	<b>CB 37</b>	4.1V
RP131L421B	<b>CB 38</b>	4.2V
RP131L431B	<b>CB 39</b>	4.3V
RP131L441B	<b>CB 40</b>	4.4V
RP131L451B	<b>CB 41</b>	4.5V
RP131L461B	<b>CB 42</b>	4.6V
RP131L471B	<b>CB 43</b>	4.7V
RP131L481B	<b>CB 44</b>	4.8V
RP131L491B	<b>CB 45</b>	4.9V
RP131L501B	<b>CB 46</b>	5.0V
RP131L101B5	<b>CB 47</b>	1.05V
RP131L511B	<b>CB 48</b>	5.1V
RP131L521B	<b>CB 49</b>	5.2V
RP131L531B	<b>CB 50</b>	5.3V
RP131L541B	<b>CB 51</b>	5.4V
RP131L551B	<b>CB 52</b>	5.5V

### RP131Lxx1D

Part Number	①②③④	Vset
RP131L081D	<b>CC 01</b>	0.8V
RP131L091D	<b>CC 02</b>	0.9V
RP131L101D	<b>CC 03</b>	1.0V
RP131L111D	<b>CC 04</b>	1.1V
RP131L121D	<b>CC 05</b>	1.2V
RP131L121D5	<b>CC 06</b>	1.25V
RP131L131D	<b>CC 07</b>	1.3V
RP131L141D	<b>CC 08</b>	1.4V
RP131L151D	<b>CC 09</b>	1.5V
RP131L161D	<b>CC 10</b>	1.6V
RP131L171D	<b>CC 11</b>	1.7V
RP131L181D	<b>CC 12</b>	1.8V
RP131L181D5	<b>CC 13</b>	1.85V
RP131L191D	<b>CC 14</b>	1.9V
RP131L201D	<b>CC 15</b>	2.0V
RP131L211D	<b>CC 16</b>	2.1V
RP131L221D	<b>CC 17</b>	2.2V
RP131L231D	<b>CC 18</b>	2.3V
RP131L241D	<b>CC 19</b>	2.4V
RP131L251D	<b>CC 20</b>	2.5V
RP131L261D	<b>CC 21</b>	2.6V
RP131L271D	<b>CC 22</b>	2.7V
RP131L281D	<b>CC 23</b>	2.8V
RP131L281D5	<b>CC 24</b>	2.85V
RP131L291D	<b>CC 25</b>	2.9V
RP131L301D	<b>CC 26</b>	3.0V
RP131L311D	<b>CC 27</b>	3.1V
RP131L321D	<b>CC 28</b>	3.2V
RP131L331D	<b>CC 29</b>	3.3V
RP131L341D	<b>CC 30</b>	3.4V
RP131L351D	<b>CC 31</b>	3.5V
RP131L361D	<b>CC 32</b>	3.6V
RP131L371D	<b>CC 33</b>	3.7V
RP131L381D	<b>CC 34</b>	3.8V
RP131L391D	<b>CC 35</b>	3.9V
RP131L401D	<b>CC 36</b>	4.0V
RP131L411D	<b>CC 37</b>	4.1V
RP131L421D	<b>CC 38</b>	4.2V
RP131L431D	<b>CC 39</b>	4.3V
RP131L441D	<b>CC 40</b>	4.4V
RP131L451D	<b>CC 41</b>	4.5V
RP131L461D	<b>CC 42</b>	4.6V
RP131L471D	<b>CC 43</b>	4.7V
RP131L481D	<b>CC 44</b>	4.8V
RP131L491D	<b>CC 45</b>	4.9V
RP131L501D	<b>CC 46</b>	5.0V
RP131L101D5	<b>CC 47</b>	1.05V
RP131L511D	<b>CC 48</b>	5.1V
RP131L521D	<b>CC 49</b>	5.2V
RP131L531D	<b>CC 50</b>	5.3V
RP131L541D	<b>CC 51</b>	5.4V
RP131L551D	<b>CC 52</b>	5.5V

# RP131x

NO.EA-174-160426

## Power Dissipation (DFN(PLP)1820-6)

This specification is at mounted on board. Power Dissipation ( $P_D$ ) depends on conditions of mounting on board. This specification is based on the measurement at the condition below:

### Measurement Conditions

	Standard Land Pattern
Environment	Mounting on Board (Wind velocity=0m/s)
Board Material	Glass cloth epoxy plastic (Double-sided)
Board Dimensions	40mm * 40mm * 1.6mm
Copper Ratio	Top side: Approx. 50%, Back side: Approx. 50%
Through-hole	$\phi 0.54\text{mm} * 30\text{pcs}$

### Measurement Result

( $T_a=25^\circ\text{C}$ )

	Standard Land Pattern
Power Dissipation	880mW( $T_{j\text{max}}=125^\circ\text{C}$ ) 1100mW( $T_{j\text{max}}=150^\circ\text{C}$ )
Thermal Resistance	$\theta_{ja}=(125 - 25^\circ\text{C})/0.88\text{W}=114^\circ\text{C/W}$



Measurement Board Pattern

○ IC Mount Area Unit: mm

- The above graph shows the Power Dissipation of the package based on  $T_{j\text{max}}=125^\circ\text{C}$  and  $T_{j\text{max}}=150^\circ\text{C}$ . Operating the IC in the shaded area in the graph might have an influence it's lifetime.

Operating time must be within the time limit described in the table below, in case of operating in the shaded area.

Operating Time	Estimated years (Operating four hours/day)
13,000 hours	9years



Package Dimensions (DFN(PLP)1820-6)

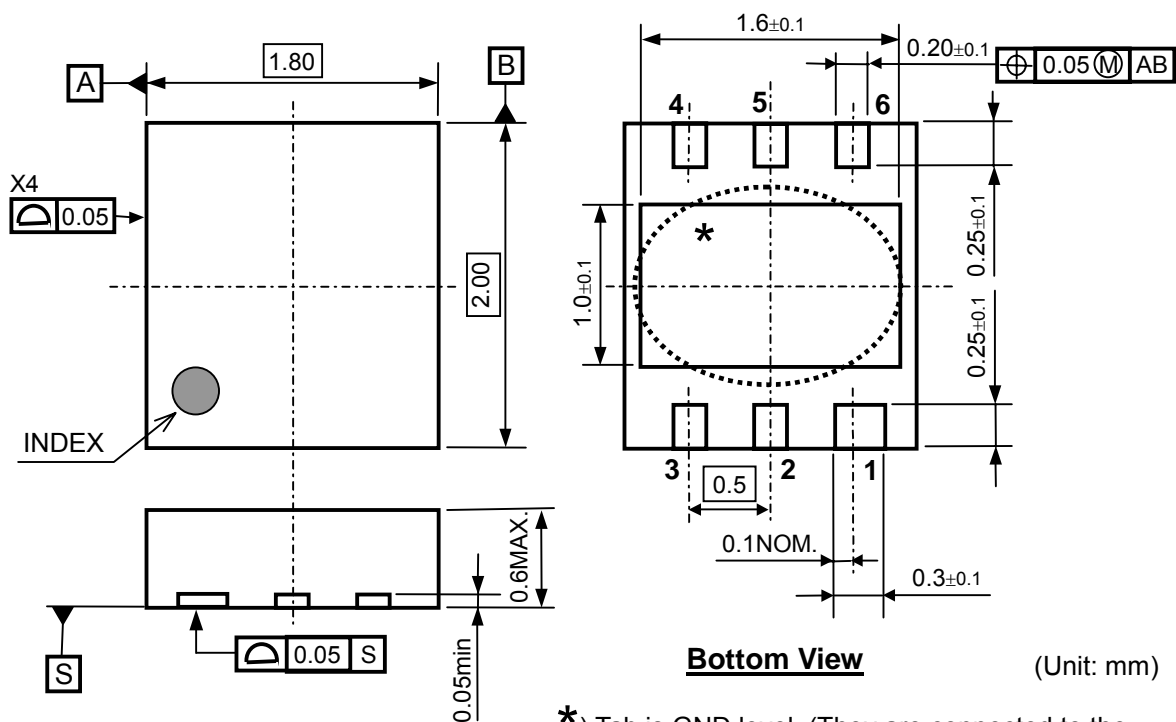

\* ) Tab is GND level. (They are connected to the reverse side of this IC.)  
 The tab is better to be connected to the GND, but leaving it open is also acceptable.

Mark Specifications (DFN(PLP)1820-6)

①②③④ : Product Code ... Refer to RP131K Series Mark Specification Table.

⑤⑥ : Lot Number ... Alphanumeric Serial Number



## RP131K Series Mark Specification Table

PKG: DFN(PLP)1820-6

**RP131Kxx1B**

Part Number	①②③④	Vset
RP131K081B	<b>AM 01</b>	0.8V
RP131K091B	<b>AM 02</b>	0.9V
RP131K101B	<b>AM 03</b>	1.0V
RP131K111B	<b>AM 04</b>	1.1V
RP131K121B	<b>AM 05</b>	1.2V
RP131K121B5	<b>AM 06</b>	1.25V
RP131K131B	<b>AM 07</b>	1.3V
RP131K141B	<b>AM 08</b>	1.4V
RP131K151B	<b>AM 09</b>	1.5V
RP131K161B	<b>AM 10</b>	1.6V
RP131K171B	<b>AM 11</b>	1.7V
RP131K181B	<b>AM 12</b>	1.8V
RP131K181B5	<b>AM 13</b>	1.85V
RP131K191B	<b>AM 14</b>	1.9V
RP131K201B	<b>AM 15</b>	2.0V
RP131K211B	<b>AM 16</b>	2.1V
RP131K221B	<b>AM 17</b>	2.2V
RP131K231B	<b>AM 18</b>	2.3V
RP131K241B	<b>AM 19</b>	2.4V
RP131K251B	<b>AM 20</b>	2.5V
RP131K261B	<b>AM 21</b>	2.6V
RP131K271B	<b>AM 22</b>	2.7V
RP131K281B	<b>AM 23</b>	2.8V
RP131K281B5	<b>AM 24</b>	2.85V
RP131K291B	<b>AM 25</b>	2.9V
RP131K301B	<b>AM 26</b>	3.0V
RP131K311B	<b>AM 27</b>	3.1V
RP131K321B	<b>AM 28</b>	3.2V
RP131K331B	<b>AM 29</b>	3.3V
RP131K341B	<b>AM 30</b>	3.4V
RP131K351B	<b>AM 31</b>	3.5V
RP131K361B	<b>AM 32</b>	3.6V
RP131K371B	<b>AM 33</b>	3.7V
RP131K381B	<b>AM 34</b>	3.8V
RP131K391B	<b>AM 35</b>	3.9V
RP131K401B	<b>AM 36</b>	4.0V
RP131K411B	<b>AM 37</b>	4.1V
RP131K421B	<b>AM 38</b>	4.2V
RP131K431B	<b>AM 39</b>	4.3V
RP131K441B	<b>AM 40</b>	4.4V
RP131K451B	<b>AM 41</b>	4.5V
RP131K461B	<b>AM 42</b>	4.6V
RP131K471B	<b>AM 43</b>	4.7V
RP131K481B	<b>AM 44</b>	4.8V
RP131K491B	<b>AM 45</b>	4.9V
RP131K501B	<b>AM 46</b>	5.0V
RP131K101B5	<b>AM 47</b>	1.05V
RP131K551B	<b>AM 48</b>	5.5V
RP131K511B	<b>AM 49</b>	5.1V
RP131K521B	<b>AM 50</b>	5.2V
RP131K531B	<b>AM 51</b>	5.3V
RP131K541B	<b>AM 52</b>	5.4V

**RP131Kxx1D**

Part Number	①②③④	Vset
RP131K081D	<b>AN 01</b>	0.8V
RP131K091D	<b>AN 02</b>	0.9V
RP131K101D	<b>AN 03</b>	1.0V
RP131K111D	<b>AN 04</b>	1.1V
RP131K121D	<b>AN 05</b>	1.2V
RP131K121D5	<b>AN 06</b>	1.25V
RP131K131D	<b>AN 07</b>	1.3V
RP131K141D	<b>AN 08</b>	1.4V
RP131K151D	<b>AN 09</b>	1.5V
RP131K161D	<b>AN 10</b>	1.6V
RP131K171D	<b>AN 11</b>	1.7V
RP131K181D	<b>AN 12</b>	1.8V
RP131K181D5	<b>AN 13</b>	1.85V
RP131K191D	<b>AN 14</b>	1.9V
RP131K201D	<b>AN 15</b>	2.0V
RP131K211D	<b>AN 16</b>	2.1V
RP131K221D	<b>AN 17</b>	2.2V
RP131K231D	<b>AN 18</b>	2.3V
RP131K241D	<b>AN 19</b>	2.4V
RP131K251D	<b>AN 20</b>	2.5V
RP131K261D	<b>AN 21</b>	2.6V
RP131K271D	<b>AN 22</b>	2.7V
RP131K281D	<b>AN 23</b>	2.8V
RP131K281D5	<b>AN 24</b>	2.85V
RP131K291D	<b>AN 25</b>	2.9V
RP131K301D	<b>AN 26</b>	3.0V
RP131K311D	<b>AN 27</b>	3.1V
RP131K321D	<b>AN 28</b>	3.2V
RP131K331D	<b>AN 29</b>	3.3V
RP131K341D	<b>AN 30</b>	3.4V
RP131K351D	<b>AN 31</b>	3.5V
RP131K361D	<b>AN 32</b>	3.6V
RP131K371D	<b>AN 33</b>	3.7V
RP131K381D	<b>AN 34</b>	3.8V
RP131K391D	<b>AN 35</b>	3.9V
RP131K401D	<b>AN 36</b>	4.0V
RP131K411D	<b>AN 37</b>	4.1V
RP131K421D	<b>AN 38</b>	4.2V
RP131K431D	<b>AN 39</b>	4.3V
RP131K441D	<b>AN 40</b>	4.4V
RP131K451D	<b>AN 41</b>	4.5V
RP131K461D	<b>AN 42</b>	4.6V
RP131K471D	<b>AN 43</b>	4.7V
RP131K481D	<b>AN 44</b>	4.8V
RP131K491D	<b>AN 45</b>	4.9V
RP131K501D	<b>AN 46</b>	5.0V
RP131K101D5	<b>AN 47</b>	1.05V
RP131K551D	<b>AN 48</b>	5.5V
RP131K511D	<b>AN 49</b>	5.1V
RP131K521D	<b>AN 50</b>	5.2V
RP131K531D	<b>AN 51</b>	5.3V
RP131K541D	<b>AN 52</b>	5.4V

**Power Dissipation (SOT-89-5)**

This specification is at mounted on board. Power Dissipation ( $P_D$ ) depends on conditions of mounting on board. This specification is based on the measurement at the condition below:

**Measurement Conditions**

	High Wattage Land Pattern	Standard Land Pattern
Environment	Mounting on Board (Wind velocity=0m/s)	Mounting on Board (Wind velocity=0m/s)
Board Material	Glass cloth epoxy plastic (Double-sided)	Glass cloth epoxy plastic (Double-sided)
Board Dimensions	30mm * 30mm * 1.6mm	50mm * 50mm * 1.6mm
Copper Ratio	Top side: Approx. 20% Back side: Approx. 100%	Top side: Approx. 10% Back side: Approx. 100%
Through-hole	$\phi$ 0.85mm * 10pcs	-

**Measurement Result**

( $T_a=25^\circ\text{C}$ )

	High Wattage Land Pattern	Standard Land Pattern	Free Air
Power Dissipation	1300mW	900mW ( $T_{jmax}=125^\circ\text{C}$ ) 1125mW ( $T_{jmax}=150^\circ\text{C}$ )	500mW
Thermal Resistance	77°C/W	111°C/W	200°C/W



**Power Dissipation**



**Measurement Board Pattern**

○ IC Mount Area Unit: mm

- The above graph shows the Power Dissipation of the package based on  $T_{jmax}=125^\circ\text{C}$  and  $T_{jmax}=150^\circ\text{C}$ .

Operating the IC in the shaded area in the graph might have an influence it's lifetime.

Operating time must be within the time limit described in the table below, in case of operating in the shaded area.

Operating Time	Estimated years (Operating four hours/day)
4,500 hours	3years

**RP131x**

NO.EA-174-160426

**Package Dimensions (SOT-89-5)**

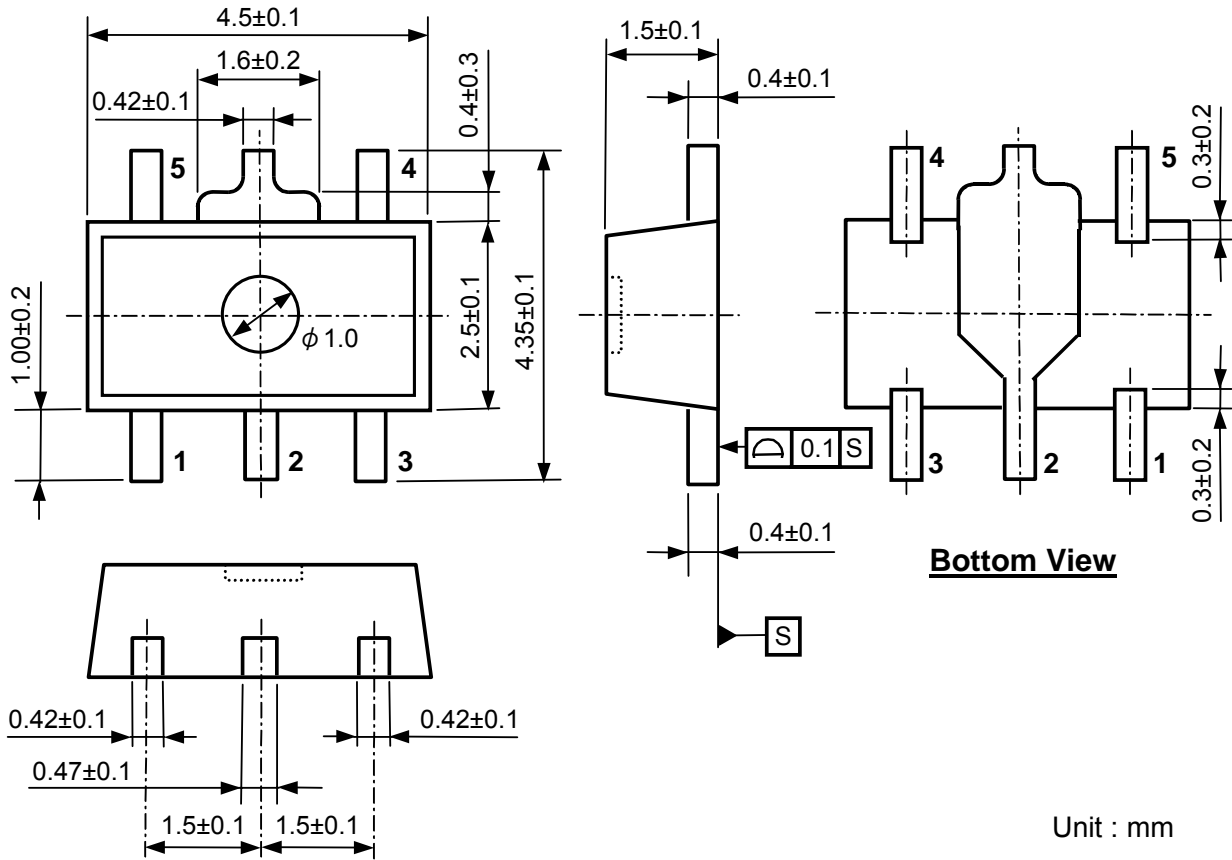

**Mark Specifications (SOT-89-5)**

①②③④: Product Code ... Refer to RP131H Series Mark Specification Table.

⑤⑥: Lot Number ... Alphanumeric Serial Number

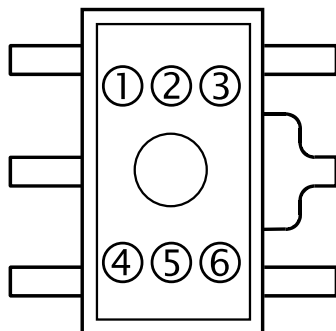

## RP131H Series Mark Specification Table

PKG: SOT-89-5

### RP131Hxx1B

Part Number	①②③④	Vset
RP131H081B	<b>U 0 8 B</b>	0.8V
RP131H091B	<b>U 0 9 B</b>	0.9V
RP131H101B	<b>U 1 0 B</b>	1.0V
RP131H111B	<b>U 1 1 B</b>	1.1V
RP131H121B	<b>U 1 2 B</b>	1.2V
RP131H131B	<b>U 1 3 B</b>	1.3V
RP131H141B	<b>U 1 4 B</b>	1.4V
RP131H151B	<b>U 1 5 B</b>	1.5V
RP131H161B	<b>U 1 6 B</b>	1.6V
RP131H171B	<b>U 1 7 B</b>	1.7V
RP131H181B	<b>U 1 8 B</b>	1.8V
RP131H191B	<b>U 1 9 B</b>	1.9V
RP131H201B	<b>U 2 0 B</b>	2.0V
RP131H211B	<b>U 2 1 B</b>	2.1V
RP131H221B	<b>U 2 2 B</b>	2.2V
RP131H231B	<b>U 2 3 B</b>	2.3V
RP131H241B	<b>U 2 4 B</b>	2.4V
RP131H251B	<b>U 2 5 B</b>	2.5V
RP131H261B	<b>U 2 6 B</b>	2.6V
RP131H271B	<b>U 2 7 B</b>	2.7V
RP131H281B	<b>U 2 8 B</b>	2.8V
RP131H291B	<b>U 2 9 B</b>	2.9V
RP131H301B	<b>U 3 0 B</b>	3.0V
RP131H311B	<b>U 3 1 B</b>	3.1V
RP131H321B	<b>U 3 2 B</b>	3.2V
RP131H331B	<b>U 3 3 B</b>	3.3V
RP131H341B	<b>U 3 4 B</b>	3.4V
RP131H351B	<b>U 3 5 B</b>	3.5V
RP131H361B	<b>U 3 6 B</b>	3.6V
RP131H371B	<b>U 3 7 B</b>	3.7V
RP131H381B	<b>U 3 8 B</b>	3.8V
RP131H391B	<b>U 3 9 B</b>	3.9V
RP131H401B	<b>U 4 0 B</b>	4.0V
RP131H411B	<b>U 4 1 B</b>	4.1V
RP131H421B	<b>U 4 2 B</b>	4.2V
RP131H431B	<b>U 4 3 B</b>	4.3V
RP131H441B	<b>U 4 4 B</b>	4.4V
RP131H451B	<b>U 4 5 B</b>	4.5V
RP131H461B	<b>U 4 6 B</b>	4.6V
RP131H471B	<b>U 4 7 B</b>	4.7V
RP131H481B	<b>U 4 8 B</b>	4.8V
RP131H491B	<b>U 4 9 B</b>	4.9V
RP131H501B	<b>U 5 0 B</b>	5.0V
RP131H511B	<b>U 5 1 B</b>	5.1V
RP131H521B	<b>U 5 2 B</b>	5.2V
RP131H531B	<b>U 5 3 B</b>	5.3V
RP131H541B	<b>U 5 4 B</b>	5.4V
RP131H551B	<b>U 5 5 B</b>	5.5V
RP131H121B5	<b>U 0 1 B</b>	1.25V
RP131H181B5	<b>U 0 2 B</b>	1.85V
RP131H281B5	<b>U 0 3 B</b>	2.85V
RP131H101B5	<b>U 0 4 B</b>	1.05V

### RP131Hxx1D

Part Number	①②③④	Vset
RP131H081D	<b>U 0 8 D</b>	0.8V
RP131H091D	<b>U 0 9 D</b>	0.9V
RP131H101D	<b>U 1 0 D</b>	1.0V
RP131H111D	<b>U 1 1 D</b>	1.1V
RP131H121D	<b>U 1 2 D</b>	1.2V
RP131H131D	<b>U 1 3 D</b>	1.3V
RP131H141D	<b>U 1 4 D</b>	1.4V
RP131H151D	<b>U 1 5 D</b>	1.5V
RP131H161D	<b>U 1 6 D</b>	1.6V
RP131H171D	<b>U 1 7 D</b>	1.7V
RP131H181D	<b>U 1 8 D</b>	1.8V
RP131H191D	<b>U 1 9 D</b>	1.9V
RP131H201D	<b>U 2 0 D</b>	2.0V
RP131H211D	<b>U 2 1 D</b>	2.1V
RP131H221D	<b>U 2 2 D</b>	2.2V
RP131H231D	<b>U 2 3 D</b>	2.3V
RP131H241D	<b>U 2 4 D</b>	2.4V
RP131H251D	<b>U 2 5 D</b>	2.5V
RP131H261D	<b>U 2 6 D</b>	2.6V
RP131H271D	<b>U 2 7 D</b>	2.7V
RP131H281D	<b>U 2 8 D</b>	2.8V
RP131H291D	<b>U 2 9 D</b>	2.9V
RP131H301D	<b>U 3 0 D</b>	3.0V
RP131H311D	<b>U 3 1 D</b>	3.1V
RP131H321D	<b>U 3 2 D</b>	3.2V
RP131H331D	<b>U 3 3 D</b>	3.3V
RP131H341D	<b>U 3 4 D</b>	3.4V
RP131H351D	<b>U 3 5 D</b>	3.5V
RP131H361D	<b>U 3 6 D</b>	3.6V
RP131H371D	<b>U 3 7 D</b>	3.7V
RP131H381D	<b>U 3 8 D</b>	3.8V
RP131H391D	<b>U 3 9 D</b>	3.9V
RP131H401D	<b>U 4 0 D</b>	4.0V
RP131H411D	<b>U 4 1 D</b>	4.1V
RP131H421D	<b>U 4 2 D</b>	4.2V
RP131H431D	<b>U 4 3 D</b>	4.3V
RP131H441D	<b>U 4 4 D</b>	4.4V
RP131H451D	<b>U 4 5 D</b>	4.5V
RP131H461D	<b>U 4 6 D</b>	4.6V
RP131H471D	<b>U 4 7 D</b>	4.7V
RP131H481D	<b>U 4 8 D</b>	4.8V
RP131H491D	<b>U 4 9 D</b>	4.9V
RP131H501D	<b>U 5 0 D</b>	5.0V
RP131H511D	<b>U 5 1 D</b>	5.1V
RP131H521D	<b>U 5 2 D</b>	5.2V
RP131H531D	<b>U 5 3 D</b>	5.3V
RP131H541D	<b>U 5 4 D</b>	5.4V
RP131H551D	<b>U 5 5 D</b>	5.5V
RP131H121D5	<b>U 0 1 D</b>	1.25V
RP131H181D5	<b>U 0 2 D</b>	1.85V
RP131H281D5	<b>U 0 3 D</b>	2.85V
RP131H101D5	<b>U 0 4 D</b>	1.05V

# RP131x

NO.EA-174-160426

## Power Dissipation (HSOP-6J)

This specification is at mounted on board. Power Dissipation ( $P_D$ ) depends on conditions of mounting on board. This specification is based on the measurement at the condition below:

### Measurement Conditions

	High Wattage Land Pattern	Standard Land Pattern
Environment	Mounting on Board (Wind velocity=0m/s)	Mounting on Board (Wind velocity=0m/s)
Board Material	Glass cloth epoxy plastic (Double-sided)	Glass cloth epoxy plastic (Double-sided)
Board Dimensions	50mm * 50mm * 1.6mm	50mm * 50mm * 1.6mm
Copper Ratio	90%	50%
Through-hole	$\phi 0.5\text{mm} * 44\text{pcs}$	$\phi 0.5\text{mm} * 44\text{pcs}$

### Measurement Result

( $T_a=25^\circ\text{C}$ )

	High Wattage Land Pattern	Standard Land Pattern	Free Air
Power Dissipation	2000mW	1700mW ( $T_{j\text{max}}=125^\circ\text{C}$ ) 2125mW ( $T_{j\text{max}}=150^\circ\text{C}$ )	540mW
Thermal Resistance	$50^\circ\text{C/W}$	$59^\circ\text{C/W}$	$185^\circ\text{C/W}$



### Power Dissipation



High Wattage

Standard

Measurement Board Pattern

○ IC Mount Area Unit: mm

- The above graph shows the Power Dissipation of the package based on  $T_{j\text{max}}=125^\circ\text{C}$  and  $T_{j\text{max}}=150^\circ\text{C}$ . Operating the IC in the shaded area in the graph might have an influence its lifetime. Operating time must be within the time limit described in the table below, in case of operating in the shaded area.

Operating Time
1,500 hours

Package Dimensions (HSOP-6J)



Mark Specifications (HSOP-6J)

①②③④: Product Code ... Refer to RP131S Series Mark Specification Table.

⑤⑥: Lot Number ... Alphanumeric Serial Number

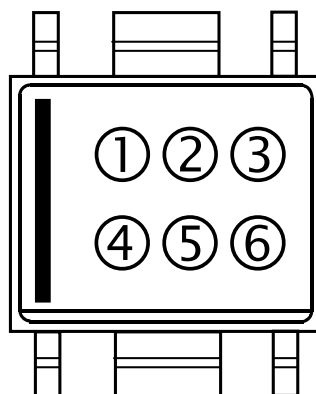

## RP131S Series Mark Specification Table

PKG: HSOP-6J

**RP131Sxx1B**

Part Number	①②③④	Vset
RP131S081B	<b>G 0 8 B</b>	0.8V
RP131S091B	<b>G 0 9 B</b>	0.9V
RP131S101B	<b>G 1 0 B</b>	1.0V
RP131S111B	<b>G 1 1 B</b>	1.1V
RP131S121B	<b>G 1 2 B</b>	1.2V
RP131S131B	<b>G 1 3 B</b>	1.3V
RP131S141B	<b>G 1 4 B</b>	1.4V
RP131S151B	<b>G 1 5 B</b>	1.5V
RP131S161B	<b>G 1 6 B</b>	1.6V
RP131S171B	<b>G 1 7 B</b>	1.7V
RP131S181B	<b>G 1 8 B</b>	1.8V
RP131S191B	<b>G 1 9 B</b>	1.9V
RP131S201B	<b>G 2 0 B</b>	2.0V
RP131S211B	<b>G 2 1 B</b>	2.1V
RP131S221B	<b>G 2 2 B</b>	2.2V
RP131S231B	<b>G 2 3 B</b>	2.3V
RP131S241B	<b>G 2 4 B</b>	2.4V
RP131S251B	<b>G 2 5 B</b>	2.5V
RP131S261B	<b>G 2 6 B</b>	2.6V
RP131S271B	<b>G 2 7 B</b>	2.7V
RP131S281B	<b>G 2 8 B</b>	2.8V
RP131S291B	<b>G 2 9 B</b>	2.9V
RP131S301B	<b>G 3 0 B</b>	3.0V
RP131S311B	<b>G 3 1 B</b>	3.1V
RP131S321B	<b>G 3 2 B</b>	3.2V
RP131S331B	<b>G 3 3 B</b>	3.3V
RP131S341B	<b>G 3 4 B</b>	3.4V
RP131S351B	<b>G 3 5 B</b>	3.5V
RP131S361B	<b>G 3 6 B</b>	3.6V
RP131S371B	<b>G 3 7 B</b>	3.7V
RP131S381B	<b>G 3 8 B</b>	3.8V
RP131S391B	<b>G 3 9 B</b>	3.9V
RP131S401B	<b>G 4 0 B</b>	4.0V
RP131S411B	<b>G 4 1 B</b>	4.1V
RP131S421B	<b>G 4 2 B</b>	4.2V
RP131S431B	<b>G 4 3 B</b>	4.3V
RP131S441B	<b>G 4 4 B</b>	4.4V
RP131S451B	<b>G 4 5 B</b>	4.5V
RP131S461B	<b>G 4 6 B</b>	4.6V
RP131S471B	<b>G 4 7 B</b>	4.7V
RP131S481B	<b>G 4 8 B</b>	4.8V
RP131S491B	<b>G 4 9 B</b>	4.9V
RP131S501B	<b>G 5 0 B</b>	5.0V
RP131S511B	<b>G 5 1 B</b>	5.1V
RP131S521B	<b>G 5 2 B</b>	5.2V
RP131S531B	<b>G 5 3 B</b>	5.3V
RP131S541B	<b>G 5 4 B</b>	5.4V
RP131S551B	<b>G 5 5 B</b>	5.5V
RP131S121B5	<b>G 0 1 B</b>	1.25V
RP131S181B5	<b>G 0 2 B</b>	1.85V
RP131S281B5	<b>G 0 3 B</b>	2.85V
RP131S101B5	<b>G 0 4 B</b>	1.05V

**RP131Sxx1D**

Part Number	①②③④	Vset
RP131S081D	<b>G 0 8 D</b>	0.8V
RP131S091D	<b>G 0 9 D</b>	0.9V
RP131S101D	<b>G 1 0 D</b>	1.0V
RP131S111D	<b>G 1 1 D</b>	1.1V
RP131S121D	<b>G 1 2 D</b>	1.2V
RP131S131D	<b>G 1 3 D</b>	1.3V
RP131S141D	<b>G 1 4 D</b>	1.4V
RP131S151D	<b>G 1 5 D</b>	1.5V
RP131S161D	<b>G 1 6 D</b>	1.6V
RP131S171D	<b>G 1 7 D</b>	1.7V
RP131S181D	<b>G 1 8 D</b>	1.8V
RP131S191D	<b>G 1 9 D</b>	1.9V
RP131S201D	<b>G 2 0 D</b>	2.0V
RP131S211D	<b>G 2 1 D</b>	2.1V
RP131S221D	<b>G 2 2 D</b>	2.2V
RP131S231D	<b>G 2 3 D</b>	2.3V
RP131S241D	<b>G 2 4 D</b>	2.4V
RP131S251D	<b>G 2 5 D</b>	2.5V
RP131S261D	<b>G 2 6 D</b>	2.6V
RP131S271D	<b>G 2 7 D</b>	2.7V
RP131S281D	<b>G 2 8 D</b>	2.8V
RP131S291D	<b>G 2 9 D</b>	2.9V
RP131S301D	<b>G 3 0 D</b>	3.0V
RP131S311D	<b>G 3 1 D</b>	3.1V
RP131S321D	<b>G 3 2 D</b>	3.2V
RP131S331D	<b>G 3 3 D</b>	3.3V
RP131S341D	<b>G 3 4 D</b>	3.4V
RP131S351D	<b>G 3 5 D</b>	3.5V
RP131S361D	<b>G 3 6 D</b>	3.6V
RP131S371D	<b>G 3 7 D</b>	3.7V
RP131S381D	<b>G 3 8 D</b>	3.8V
RP131S391D	<b>G 3 9 D</b>	3.9V
RP131S401D	<b>G 4 0 D</b>	4.0V
RP131S411D	<b>G 4 1 D</b>	4.1V
RP131S421D	<b>G 4 2 D</b>	4.2V
RP131S431D	<b>G 4 3 D</b>	4.3V
RP131S441D	<b>G 4 4 D</b>	4.4V
RP131S451D	<b>G 4 5 D</b>	4.5V
RP131S461D	<b>G 4 6 D</b>	4.6V
RP131S471D	<b>G 4 7 D</b>	4.7V
RP131S481D	<b>G 4 8 D</b>	4.8V
RP131S491D	<b>G 4 9 D</b>	4.9V
RP131S501D	<b>G 5 0 D</b>	5.0V
RP131S511D	<b>G 5 1 D</b>	5.1V
RP131S521D	<b>G 5 2 D</b>	5.2V
RP131S531D	<b>G 5 3 D</b>	5.3V
RP131S541D	<b>G 5 4 D</b>	5.4V
RP131S551D	<b>G 5 5 D</b>	5.5V
RP131S121D5	<b>G 0 1 D</b>	1.25V
RP131S181D5	<b>G 0 2 D</b>	1.85V
RP131S281D5	<b>G 0 3 D</b>	2.85V
RP131S101D5	<b>G 0 4 D</b>	1.05V



**Power Dissipation (TO-252-5-P2)**

This specification is at mounted on board. Power Dissipation ( $P_D$ ) depends on conditions of mounting on board. This specification is based on the measurement at the condition below:

Measurement conditions

	Land Pattern A	Land Pattern B
Environment	Mounting on board (Wind velocity 0m/s)	Mounting on board (Wind velocity 0m/s)
Board Material	Glass cloth epoxy plastic (Double-layers)	Glass cloth epoxy plastic (Four-layers)
Board Dimensions	50mm * 50mm * 1.6mm	76.2mm * 114.3mm * 0.8mm
Copper Ratio	Top side: Approx. 50%, Back side: Approx. 50%	Top, Back side: Approx. 96%, 2nd, 3rd: 100%
Through - hole	$\phi$ 0.5mm * 24pcs	$\phi$ 0.4mm * 30pcs

Measurement Results

( $T_a=25^\circ\text{C}$ )

	Land pattern A	Land pattern B
Power Dissipation	1900mW ( $T_{jmax}=125^\circ\text{C}$ ) 2375mW ( $T_{jmax}=150^\circ\text{C}$ )	3800mW ( $T_{jmax}=125^\circ\text{C}$ ) 4750mW ( $T_{jmax}=150^\circ\text{C}$ )
Thermal Resistance	$\theta_{ja}=(125-25^\circ\text{C})/1.9\text{W}= 53^\circ\text{C/W}$ $\theta_{jc}= 17^\circ\text{C/W}$	$\theta_{ja}= (125-25^\circ\text{C})/3.8\text{W} = 26^\circ\text{C/W}$ $\theta_{jc}= 7^\circ\text{C/W}$



Power Dissipation



Measurent Board Pattern

Measurent Board Pattern

○ IC Mount Area Unit : mm

○ IC Mount Area Unit : mm

- The above graph shows the Power Dissipation of the package based on  $T_{jmax}=125^\circ\text{C}$  and  $T_{jmax}=150^\circ\text{C}$ . Operating the IC in the shaded area in the graph might have an influence it's lifetime. Operating time must be within the time limit described in the table below, in case of operating in the shaded area.

Operating Time	Estimated years (Operating four hours/day)
13,000 hours	9years

**RP131x**

NO.EA-174-160426

**Package Dimensions (TO-252-5-P2)**



**Mark Specifications (TO-252-5-P2)**

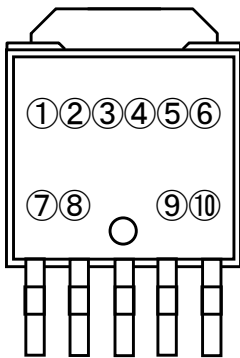

①②③④⑤⑥⑦⑧: Refer to RP131J Series Mark Specification Table.

⑨⑩: Lot Number ... Alphanumeric Serial Number

## RP131J Series Mark Specification Table

PKG: TO-252-5

### RP131Jxx1B

Part Number	①②③④⑤⑥⑦⑧	Vset
RP131J081B	D 1 J 0 8 1 B	0.8V
RP131J091B	D 1 J 0 9 1 B	0.9V
RP131J101B	D 1 J 1 0 1 B	1.0V
RP131J111B	D 1 J 1 1 1 B	1.1V
RP131J121B	D 1 J 1 2 1 B	1.2V
RP131J131B	D 1 J 1 3 1 B	1.3V
RP131J141B	D 1 J 1 4 1 B	1.4V
RP131J151B	D 1 J 1 5 1 B	1.5V
RP131J161B	D 1 J 1 6 1 B	1.6V
RP131J171B	D 1 J 1 7 1 B	1.7V
RP131J181B	D 1 J 1 8 1 B	1.8V
RP131J191B	D 1 J 1 9 1 B	1.9V
RP131J201B	D 1 J 2 0 1 B	2.0V
RP131J211B	D 1 J 2 1 1 B	2.1V
RP131J221B	D 1 J 2 2 1 B	2.2V
RP131J231B	D 1 J 2 3 1 B	2.3V
RP131J241B	D 1 J 2 4 1 B	2.4V
RP131J251B	D 1 J 2 5 1 B	2.5V
RP131J261B	D 1 J 2 6 1 B	2.6V
RP131J271B	D 1 J 2 7 1 B	2.7V
RP131J281B	D 1 J 2 8 1 B	2.8V
RP131J291B	D 1 J 2 9 1 B	2.9V
RP131J301B	D 1 J 3 0 1 B	3.0V
RP131J311B	D 1 J 3 1 1 B	3.1V
RP131J321B	D 1 J 3 2 1 B	3.2V
RP131J331B	D 1 J 3 3 1 B	3.3V
RP131J341B	D 1 J 3 4 1 B	3.4V
RP131J351B	D 1 J 3 5 1 B	3.5V
RP131J361B	D 1 J 3 6 1 B	3.6V
RP131J371B	D 1 J 3 7 1 B	3.7V
RP131J381B	D 1 J 3 8 1 B	3.8V
RP131J391B	D 1 J 3 9 1 B	3.9V
RP131J401B	D 1 J 4 0 1 B	4.0V
RP131J411B	D 1 J 4 1 1 B	4.1V
RP131J421B	D 1 J 4 2 1 B	4.2V
RP131J431B	D 1 J 4 3 1 B	4.3V
RP131J441B	D 1 J 4 4 1 B	4.4V
RP131J451B	D 1 J 4 5 1 B	4.5V
RP131J461B	D 1 J 4 6 1 B	4.6V
RP131J471B	D 1 J 4 7 1 B	4.7V
RP131J481B	D 1 J 4 8 1 B	4.8V
RP131J491B	D 1 J 4 9 1 B	4.9V
RP131J501B	D 1 J 5 0 1 B	5.0V
RP131J511B	D 1 J 5 1 1 B	5.1V
RP131J521B	D 1 J 5 2 1 B	5.2V
RP131J531B	D 1 J 5 3 1 B	5.3V
RP131J541B	D 1 J 5 4 1 B	5.4V
RP131J551B	D 1 J 5 5 1 B	5.5V
RP131J121B5	D 1 J 1 2 1 B 5	1.25V
RP131J181B5	D 1 J 1 8 1 B 5	1.85V
RP131J281B5	D 1 J 2 8 1 B 5	2.85V
RP131J101B5	D 1 J 1 0 1 B 5	1.05V

### RP131Jxx1D

Part Number	①②③④⑤⑥⑦⑧	Vset
RP131J081D	D 1 J 0 8 1 D	0.8V
RP131J091D	D 1 J 0 9 1 D	0.9V
RP131J101D	D 1 J 1 0 1 D	1.0V
RP131J111D	D 1 J 1 1 1 D	1.1V
RP131J121D	D 1 J 1 2 1 D	1.2V
RP131J131D	D 1 J 1 3 1 D	1.3V
RP131J141D	D 1 J 1 4 1 D	1.4V
RP131J151D	D 1 J 1 5 1 D	1.5V
RP131J161D	D 1 J 1 6 1 D	1.6V
RP131J171D	D 1 J 1 7 1 D	1.7V
RP131J181D	D 1 J 1 8 1 D	1.8V
RP131J191D	D 1 J 1 9 1 D	1.9V
RP131J201D	D 1 J 2 0 1 D	2.0V
RP131J211D	D 1 J 2 1 1 D	2.1V
RP131J221D	D 1 J 2 2 1 D	2.2V
RP131J231D	D 1 J 2 3 1 D	2.3V
RP131J241D	D 1 J 2 4 1 D	2.4V
RP131J251D	D 1 J 2 5 1 D	2.5V
RP131J261D	D 1 J 2 6 1 D	2.6V
RP131J271D	D 1 J 2 7 1 D	2.7V
RP131J281D	D 1 J 2 8 1 D	2.8V
RP131J291D	D 1 J 2 9 1 D	2.9V
RP131J301D	D 1 J 3 0 1 D	3.0V
RP131J311D	D 1 J 3 1 1 D	3.1V
RP131J321D	D 1 J 3 2 1 D	3.2V
RP131J331D	D 1 J 3 3 1 D	3.3V
RP131J341D	D 1 J 3 4 1 D	3.4V
RP131J351D	D 1 J 3 5 1 D	3.5V
RP131J361D	D 1 J 3 6 1 D	3.6V
RP131J371D	D 1 J 3 7 1 D	3.7V
RP131J381D	D 1 J 3 8 1 D	3.8V
RP131J391D	D 1 J 3 9 1 D	3.9V
RP131J401D	D 1 J 4 0 1 D	4.0V
RP131J411D	D 1 J 4 1 1 D	4.1V
RP131J421D	D 1 J 4 2 1 D	4.2V
RP131J431D	D 1 J 4 3 1 D	4.3V
RP131J441D	D 1 J 4 4 1 D	4.4V
RP131J451D	D 1 J 4 5 1 D	4.5V
RP131J461D	D 1 J 4 6 1 D	4.6V
RP131J471D	D 1 J 4 7 1 D	4.7V
RP131J481D	D 1 J 4 8 1 D	4.8V
RP131J491D	D 1 J 4 9 1 D	4.9V
RP131J501D	D 1 J 5 0 1 D	5.0V
RP131J511D	D 1 J 5 1 1 D	5.1V
RP131J521D	D 1 J 5 2 1 D	5.2V
RP131J531D	D 1 J 5 3 1 D	5.3V
RP131J541D	D 1 J 5 4 1 D	5.4V
RP131J551D	D 1 J 5 5 1 D	5.5V
RP131J121D5	D 1 J 1 2 1 D 5	1.25V
RP131J181D5	D 1 J 1 8 1 D 5	1.85V
RP131J281D5	D 1 J 2 8 1 D 5	2.85V
RP131J101D5	D 1 J 1 0 1 D 5	1.05V



1. The products and the product specifications described in this document are subject to change or discontinuation of production without notice for reasons such as improvement. Therefore, before deciding to use the products, please refer to Ricoh sales representatives for the latest information thereon.
2. The materials in this document may not be copied or otherwise reproduced in whole or in part without prior written consent of Ricoh.
3. Please be sure to take any necessary formalities under relevant laws or regulations before exporting or otherwise taking out of your country the products or the technical information described herein.
4. The technical information described in this document shows typical characteristics of and example application circuits for the products. The release of such information is not to be construed as a warranty of or a grant of license under Ricoh's or any third party's intellectual property rights or any other rights.
5. The products listed in this document are intended and designed for use as general electronic components in standard applications (office equipment, telecommunication equipment, measuring instruments, consumer electronic products, amusement equipment etc.). Those customers intending to use a product in an application requiring extreme quality and reliability, for example, in a highly specific application where the failure or misoperation of the product could result in human injury or death (aircraft, spacevehicle, nuclear reactor control system, traffic control system, automotive and transportation equipment, combustion equipment, safety devices, life support system etc.) should first contact us.
6. We are making our continuous effort to improve the quality and reliability of our products, but semiconductor products are likely to fail with certain probability. In order to prevent any injury to persons or damages to property resulting from such failure, customers should be careful enough to incorporate safety measures in their design, such as redundancy feature, fire containment feature and fail-safe feature. We do not assume any liability or responsibility for any loss or damage arising from misuse or inappropriate use of the products.
7. Anti-radiation design is not implemented in the products described in this document.
8. Please contact Ricoh sales representatives should you have any questions or comments concerning the products or the technical information.



**Ricoh is committed to reducing the environmental loading materials in electrical devices with a view to contributing to the protection of human health and the environment.**

Ricoh has been providing RoHS compliant products since April 1, 2006 and Halogen-free products since April 1, 2012.

**RICOH** RICOH ELECTRONIC DEVICES CO., LTD.

<http://www.e-devices.ricoh.co.jp/en/>

#### Sales & Support Offices

##### **RICOH ELECTRONIC DEVICES CO., LTD.**

**Higashi-Shinagawa Office (International Sales)**  
3-32-3, Higashi-Shinagawa, Shinagawa-ku, Tokyo 140-8655, Japan  
Phone: +81-3-5479-2857 Fax: +81-3-5479-0502

##### **RICOH EUROPE (NETHERLANDS) B.V.**

**Semiconductor Support Centre**  
Prof. W.H. Keesomlaan 1, 1183 DJ Amstelveen, The Netherlands  
Phone: +31-20-5474-309

##### **RICOH INTERNATIONAL B.V. - German Branch**

**Semiconductor Sales and Support Centre**  
Oberrather Strasse 6, 40472 Düsseldorf, Germany  
Phone: +49-211-6546-0

##### **RICOH ELECTRONIC DEVICES KOREA CO., LTD.**

3F, Haesung Bldg, 504, Teheran-ro, Gangnam-gu, Seoul, 135-725, Korea  
Phone: +82-2-2135-5700 Fax: +82-2-2051-5713

##### **RICOH ELECTRONIC DEVICES SHANGHAI CO., LTD.**

Room 403, No.2 Building, No.690 Bibo Road, Pu Dong New District, Shanghai 201203, People's Republic of China  
Phone: +86-21-5027-3200 Fax: +86-21-5027-3299

##### **RICOH ELECTRONIC DEVICES CO., LTD.**

**Taipei office**  
Room 109, 10F-1, No.51, Hengyang Rd., Taipei City, Taiwan (R.O.C.)  
Phone: +886-2-2313-1621/1622 Fax: +886-2-2313-1623

# Mouser Electronics

Authorized Distributor

Click to View Pricing, Inventory, Delivery & Lifecycle Information:

## Ricoh Electronics:

[RP131H101D-T1-FE](#) [RP131S331D-E2-FE](#) [RP131S331B-E2-FE](#) [RP131H181D-T1-FE](#) [RP131H181B-T1-FE](#)  
[RP131H501B-T1-FE](#) [RP131S151B-E2-FE](#) [RP131S101B-E2-FE](#) [RP131S301D-E2-FE](#) [RP131J151D-T1-FE](#)  
[RP131H451D-T1-FE](#) [RP131H251B-T1-FE](#) [RP131S281D-E2-FE](#) [RP131S251D-E2-FE](#) [RP131S151D-E2-FE](#)  
[RP131J121D-T1-FE](#) [RP131H251D-T1-FE](#) [RP131S501D-E2-FE](#) [RP131S451D-E2-FE](#) [RP131H151D-T1-FE](#)  
[RP131H331B-T1-FE](#) [RP131H121D-T1-FE](#) [RP131S101D-E2-FE](#) [RP131S121B-E2-FE](#) [RP131H121B-T1-FE](#)  
[RP131H301D-T1-FE](#) [RP131S121D-E2-FE](#) [RP131H151B-T1-FE](#) [RP131H501D-T1-FE](#) [RP131H331D-T1-FE](#)  
[RP131S501B-E2-FE](#) [RP131S181B-E2-FE](#) [RP131S251B-E2-FE](#) [RP131S181D-E2-FE](#)



Компания «ЭлектроПласт» предлагает заключение долгосрочных отношений при поставках импортных электронных компонентов на взаимовыгодных условиях!

Наши преимущества:

- Оперативные поставки широкого спектра электронных компонентов отечественного и импортного производства напрямую от производителей и с крупнейших мировых складов;
- Поставка более 17-ти миллионов наименований электронных компонентов;
- Поставка сложных, дефицитных, либо снятых с производства позиций;
- Оперативные сроки поставки под заказ (от 5 рабочих дней);
- Экспресс доставка в любую точку России;
- Техническая поддержка проекта, помощь в подборе аналогов, поставка прототипов;
- Система менеджмента качества сертифицирована по Международному стандарту ISO 9001;
- Лицензия ФСБ на осуществление работ с использованием сведений, составляющих государственную тайну;
- Поставка специализированных компонентов (Xilinx, Altera, Analog Devices, Intersil, Interpoint, Microsemi, Aeroflex, Peregrine, Syfer, Eurofarad, Texas Instrument, Miteq, Cobham, E2V, MA-COM, Hittite, Mini-Circuits, General Dynamics и др.);

Помимо этого, одним из направлений компании «ЭлектроПласт» является направление «Источники питания». Мы предлагаем Вам помощь Конструкторского отдела:

- Подбор оптимального решения, техническое обоснование при выборе компонента;
- Подбор аналогов;
- Консультации по применению компонента;
- Поставка образцов и прототипов;
- Техническая поддержка проекта;
- Защита от снятия компонента с производства.



#### Как с нами связаться

**Телефон:** 8 (812) 309 58 32 (многоканальный)

**Факс:** 8 (812) 320-02-42

**Электронная почта:** [org@eplast1.ru](mailto:org@eplast1.ru)

**Адрес:** 198099, г. Санкт-Петербург, ул. Калинина, дом 2, корпус 4, литера А.