

LOW ON RESISTANCE / LOW VOLTAGE 1A LDO

NO.EA-174-160426

OUTLINE

The RP131x Series are voltage-regulators with a built-in low ON-resistance transistor and output current is 1A capability. These ICs are capable of the low input voltage (Min.1.6V) and also the minimum output voltage can be set from 0.8V. (The output voltage is fixed in the IC.)

Each of these ICs consists of a voltage reference unit, an error amplifier, a resistor net for setting output voltage, a chip enable circuit, current limit circuits for over-current and short, and a thermal-shutdown circuit.

A standby mode with ultra low supply current can be realized with the chip enable function.

The packages for these ICs are DFN1616-6B and DFN(PLP)1820-6 which are suitable for high density mounting of the ICs on boards. SOT-89-5, HSOP-6J and TO-252-5-P2 with high power dissipation are also available.

FEATURES

- Output Current Min. 1A
- Supply Current Typ. 65 μ A
- Standby Current Typ. 0.15 μ A
- Input Voltage Range 1.6V to 6.5V
- Output Voltage Range 0.8V to 5.5V (0.1V steps)
(For other voltages, please refer to MARK INFORMATIONS.)
- Dropout Voltage..... Typ. 0.5V ($V_{OUT}=2.8V$, $I_{OUT}=1A$)
- Ripple Rejection Typ. 70dB ($f=1kHz$, $V_{OUT}=2.8V$)
- Output Voltage Accuracy $\pm 1.0\%$
- Temperature-Drift Coefficient of Output Voltage Typ. $\pm 100ppm/^{\circ}C$
- Line Regulation Typ. 0.05%/V
- Load Regulation Typ. 20mV at $I_{OUT}=300mA$, Typ. 80mV at $I_{OUT}=1A$
- Packages DFN1616-6B, DFN(PLP)1820-6, SOT-89-5, HSOP-6J, TO-252-5-P2
- Built-in Inrush current limit circuit Typ. 500mA
- Built-in Fold-Back Protection Circuit Typ. 250mA (Current at short mode)
- Built-in Thermal Shutdown Circuit Thermal Shutdown Temperature ; Typ. 165 $^{\circ}C$
Released Temperature ; Typ. 135 $^{\circ}C$
- Built-in Auto Discharge Function D version
- Ceramic capacitors are recommended to be used with this IC 2.2 μ F or more ($V_{OUT}\leq 3.6V$)
4.7 μ F or more ($V_{OUT}> 3.6V$)

APPLICATIONS

- Power source for battery-powered equipment.
- Power source for portable communication equipment.
- Power source for electrical appliances such as cameras, VCRs and camcorders.
- Power source for Notebook PC.
- Power source for home appliances.

RP131x

NO.EA-174-160426

BLOCK DIAGRAMS



SELECTION GUIDE

The output voltage, auto discharge function, package for the ICs can be selected at the user's request.

Product Name	Package	Quantity per Reel	Pb Free	Halogen Free
RP131Lxx1*-TR	DFN1616-6B	5,000 pcs	Yes	Yes
RP131Kxx1*-TR	DFN(PLP)1820-6	5,000 pcs	Yes	Yes
RP131Hxx1*-T1-FE	SOT-89-5	1,000 pcs	Yes	Yes
RP131Sxx1*-E2-FE	HSOP-6J	1,000 pcs	Yes	Yes
RP131Jxx1*-T1-FE	TO-252-5-P2	3,000 pcs	Yes	Yes

xx : The output voltage can be designated in the range from 0.8V(08) to 5.5V(55) in 0.1V steps.
(For other voltages, please refer to MARK INFORMATIONS.)

* : The auto discharge function at off state are options as follows.
(B) without auto discharge function at off state
(D) with auto discharge function at off state

PIN CONFIGURATIONS

● DFN1616-6B



● DFN(PLP)1820-6



● SOT-89-5



● HSOP-6J

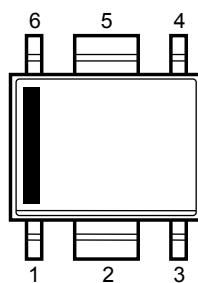

● TO-252-5-P2



PIN DESCRIPTIONS

● DFN1616-6B

Pin No.	Symbol	Pin Description
1	V_{OUT}	Output Pin*2
2	V_{OUT}	Output Pin*2
3	GND	Ground Pin
4	CE	Chip Enable Pin ("H" Active)
5	V_{DD}	Input Pin*2
6	V_{DD}	Input Pin*2

*1) Tab is GND level. (They are connected to the reverse side of this IC.)

The tab is better to be connected to the GND, but leaving it open is also acceptable.

*2) When you use this IC, please make sure be wired with 1pin with 2pin and 5pin with 6pin.

RP131x

NO.EA-174-160426

• DFN(PLP)1820-6

Pin No.	Symbol	Pin Description
1	V _{OUT}	Output Pin*2
2	V _{OUT}	Output Pin*2
3	GND	Ground Pin
4	CE	Chip Enable Pin ("H" Active)
5	V _{DD}	Input Pin*2
6	V _{DD}	Input Pin*2

*1) Tab is GND level. (They are connected to the reverse side of this IC.)

The tab is better to be connected to the GND, but leaving it open is also acceptable.

*2) When you use this IC, please make sure be wired with 1pin with 2pin and 5pin with 6pin.

• SOT-89-5

Pin No.	Symbol	Pin Description
1	NC	No Connection
2	GND	Ground Pin
3	CE	Chip Enable Pin ("H" Active)
4	V _{DD}	Input Pin
5	V _{OUT}	Output Pin

• HSOP-6J

Pin No.	Symbol	Pin Description
1	V _{OUT}	Output Pin
2	GND	Ground Pin*3
3	NC	No Connection
4	CE	Chip Enable Pin ("H" Active)
5	GND	Ground Pin*3
6	V _{DD}	Input Pin

*3) When you use this IC, please make sure be wired with 2pin and 5pin.

• TO-252-5-P2

Pin No.	Symbol	Pin Description
1	V _{OUT}	Output Pin
2	GND	Ground Pin*4
3	GND	Ground Pin*4
4	CE	Chip Enable Pin ("H" Active)
5	V _{DD}	Input Pin

*4) When you use this IC, please make sure be wired with 2pin and 3pin.

ABSOLUTE MAXIMUM RATINGS

Symbol	Item	Rating	Unit
V _{IN}	Input Voltage	7.0	V
V _{CE}	Input Voltage (CE Pin)	-0.3 to 7.0	V
V _{OUT}	Output Voltage	-0.3 to V _{IN} +0.3	V
P _D	Power Dissipation (DFN1616-6B)*	640	mW
	Power Dissipation (DFN(PLP)1820-6)*	880	
	Power Dissipation (SOT-89-5)*	900	
	Power Dissipation (HSOP-6J)*	1700	
	Power Dissipation (TO-252-5-P2)*	1900	
T _{opt}	Operating Temperature Range	-40 to 85	°C
T _{stg}	Storage Temperature Range	-55 to 125	°C

*) For Power Dissipation, please refer to PACKAGE INFORMATION.

ABSOLUTE MAXIMUM RATINGS

Electronic and mechanical stress momentarily exceeded absolute maximum ratings may cause the permanent damages and may degrade the life time and safety for both device and system using the device in the field.

The functional operation at or over these absolute maximum ratings is not assured.

RP131x

NO.EA-174-160426

ELECTRICAL CHARACTERISTICS $V_{IN} = \text{Set } V_{OUT} + 1V, I_{OUT} = 1mA$ The specification in is checked and guaranteed by design engineering at $-40^{\circ}\text{C} \leq T_{opt} \leq 85^{\circ}\text{C}$, unless otherwise noted.● **RP131xxx1B/D** $T_{opt} = 25^{\circ}\text{C}$

Symbol	Item	Conditions	Min.	Typ.	Max.	Unit	
V_{OUT}	Output Voltage	$T_{opt} = 25^{\circ}\text{C}$	$V_{OUT} > 1.5V$	$\times 0.99$		$\times 1.01$	V
			$V_{OUT} \leq 1.5V$	-15		15	mV
		$-40^{\circ}\text{C} \leq T_{opt} \leq 85^{\circ}\text{C}$	$V_{OUT} > 1.5V$	<input type="checkbox"/> $\times 0.974$		<input type="checkbox"/> $\times 1.018$	V
			$V_{OUT} \leq 1.5V$	<input type="checkbox"/> -40		<input type="checkbox"/> 27	mV
$\frac{\Delta V_{OUT}}{\Delta I_{OUT}}$	Load Regulation	$0.1mA \leq I_{OUT} \leq 300mA$		20	<input type="checkbox"/> 40	mV	
		$0.1mA \leq I_{OUT} \leq 1A$		80	<input type="checkbox"/> 120		
V_{DIF}	Dropout Voltage	Refer to the following table					
I_{SS}	Supply Current	$I_{OUT} = 0mA$ ($V_{IN} = 6.5V$)		65	<input type="checkbox"/> 90	μA	
$I_{standby}$	Standby Current	$V_{CE} = 0V, V_{IN} = 6.5V$		0.15	0.60	μA	
$\frac{\Delta V_{OUT}}{\Delta V_{IN}}$	Line Regulation	Set $V_{OUT} + 0.5V \leq V_{IN} \leq 6.5V$ *However, $V_{IN} \geq 1.6V$		0.05	<input type="checkbox"/> 0.1	%/V	
RR	Ripple Rejection	$f = 1\text{kHz}$ Ripple 0.2Vp-p $I_{OUT} = 100mA$	$V_{OUT} \leq 3.3V$		70	dB	
			$V_{OUT} > 3.3V$		60		
V_{IN}	Input Voltage		<input type="checkbox"/> 1.6		<input type="checkbox"/> 6.5	V	
$\frac{\Delta V_{OUT}}{\Delta T_{opt}}$	Output Voltage Temperature Coefficient	$-40^{\circ}\text{C} \leq T_{opt} \leq 85^{\circ}\text{C}$		± 100		ppm/ $^{\circ}\text{C}$	
I_{LIM}	Output Current Limit		<input type="checkbox"/> 1			A	
I_{SC}	Short Current Limit	$V_{OUT} = 0V$		250		mA	
I_{PD}	CE Pull-down Current			0.3		μA	
V_{CEH}	CE Input Voltage "H"		<input type="checkbox"/> 1.0			V	
V_{CEL}	CE Input Voltage "L"				<input type="checkbox"/> 0.4	V	
e_n	Output Noise	$BW = 10\text{Hz to } 100\text{kHz}, I_{OUT} = 1mA$		45		μVrms	
T_{TSD}	Thermal Shutdown Temperature	Junction Temperature		165		$^{\circ}\text{C}$	
T_{TSR}	Thermal Shutdown Released Temperature	Junction Temperature		135		$^{\circ}\text{C}$	
R_{LOW}	Low Output Nch Tr. ON Resistance (of D version)	$V_{IN} = 4.0V, V_{CE} = 0V$		30		Ω	

The specification in is checked and guaranteed by design engineering at $-40^{\circ}\text{C} \leq T_{opt} \leq 85^{\circ}\text{C}$, unless otherwise noted.All of unit are tested and specified under load conditions such that $T_j \approx T_{opt} = 25^{\circ}\text{C}$ except for Output Noise, Ripple Rejection, Output Voltage Temperature Coefficient, Dropout Voltage at 1A Output Current and Thermal Shutdown items.

• Dropout Voltage by Output Voltage

T_{opt}=25°C

Output Voltage V _{OUT} (V)	Dropout Voltage V _{DIF} (V)					
	Condition	Typ.	Max.	Condition	Typ.	Max.
0.8 ≤ V _{OUT} < 0.9	I _{OUT} =300mA	0.600	0.780	I _{OUT} =1A	1.100	1.650
0.9 ≤ V _{OUT} < 1.0		0.550	0.690		1.050	1.500
1.0 ≤ V _{OUT} < 1.1		0.450	0.610		1.000	1.450
1.1 ≤ V _{OUT} < 1.2		0.340	0.540		0.930	1.420
1.2 ≤ V _{OUT} < 1.5		0.290	0.500		0.900	1.380
1.5 ≤ V _{OUT} < 2.6		0.230	0.310		0.700	1.100
2.6 ≤ V _{OUT} < 3.3		0.150	0.180		0.500	0.750
3.3 ≤ V _{OUT} ≤ 5.5		0.140	0.170		0.450	0.650

The specification in is checked and guaranteed by design engineering at -40°C ≤ T_{opt} ≤ 85°C, unless otherwise noted.

All of unit are tested and specified under load conditions such that T_j ≈ T_{opt} = 25°C except for Output Noise, Ripple Rejection, Output Voltage Temperature Coefficient, Dropout Voltage at 1A Output Current and Thermal Shutdown items.

RECOMMENDED OPERATING CONDITIONS (ELECTRICAL CHARACTERISTICS)

All of electronic equipment should be designed that the mounted semiconductor devices operate within the recommended operating conditions. The semiconductor devices cannot operate normally over the recommended operating conditions, even if when they are used over such conditions by momentary electronic noise or surge.

And the semiconductor devices may receive serious damage when they continue to operate over the recommended operating conditions.

TYPICAL APPLICATION



Recommendation value of the external capacitors

V_{OUT}	Capacitors	
$V_{OUT} \leq 3.6V$	C1	Kyocera 2.2 μ F (size:1005) [CM05X5R225M06AB]
	C2	Kyocera 2.2 μ F (size:1608) [CM105X5R225K06AB]
$V_{OUT} > 3.6V$	C1	Kyocera 2.2 μ F (size:1608) [CM105X5R225K06AB]
	C2	Kyocera 4.7 μ F (size:1608) [CM105X5R475M06AB]

TECHNICAL NOTES

When using these ICs, consider the following points:

Phase Compensation

In these ICs, phase compensation is made for securing stable operation even if the load current is varied. For this purpose, use a capacitor C2 with good frequency characteristics and ESR (Equivalent Series Resistance).

If a tantalum capacitor is used, and its ESR of C2 is large, the loop oscillation may result. Because of this, select C2 carefully considering its frequency characteristics.

PCB Layout

Make V_{DD} and GND lines sufficient. If their impedance is high, noise pickup or unstable operation may result. Connect a capacitor C1 between V_{DD} and GND pin with a capacitance value as "Recommendation value of the external capacitors" above or more, and as close as possible to the pins.

Set external components, especially the output capacitor C2, as close as possible to the ICs, and make wiring as short as possible.

TEST CIRCUITS



Basic Test Circuit



Test Circuit for Supply Current



Test Circuit for Ripple Rejection



Test Circuit for Load Transient Response

TYPICAL CHARACTERISTICS

1) Output Voltage vs. Output Current (T_{opt}=25°C)



2) Output Voltage vs. Input Voltage (T_{opt}=25°C)





3) Supply Current vs. Input Voltage (Topt=25°C)

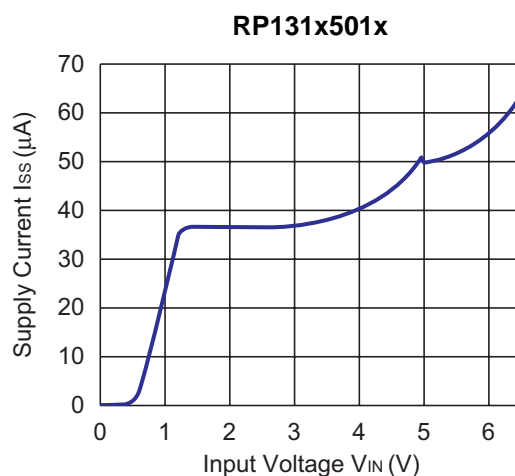
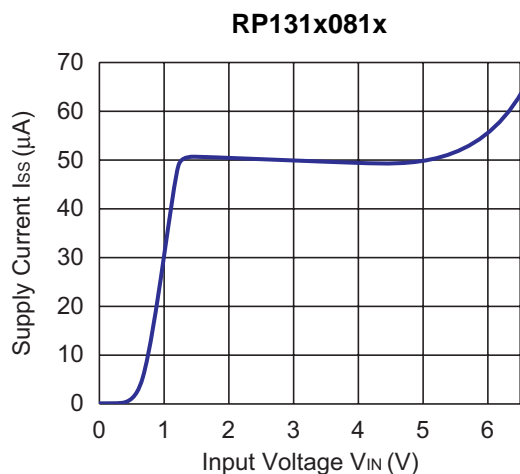

RP131x

NO.EA-174-160426

4) Output Voltage vs. Temperature

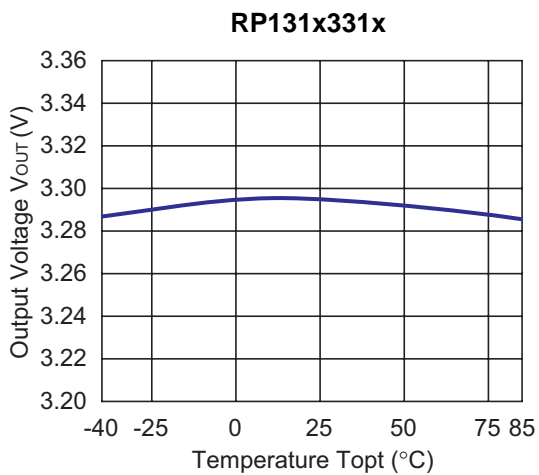
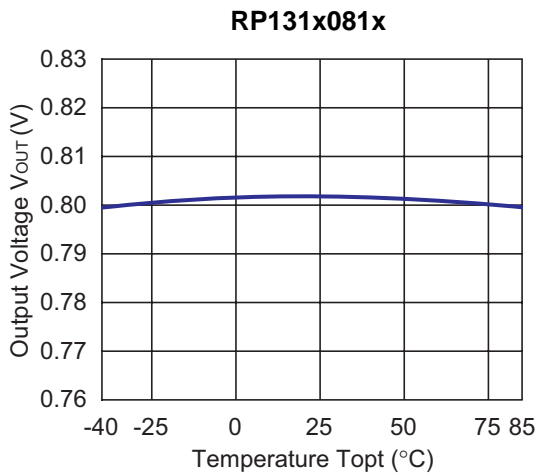

5) Supply Current vs. Temperature

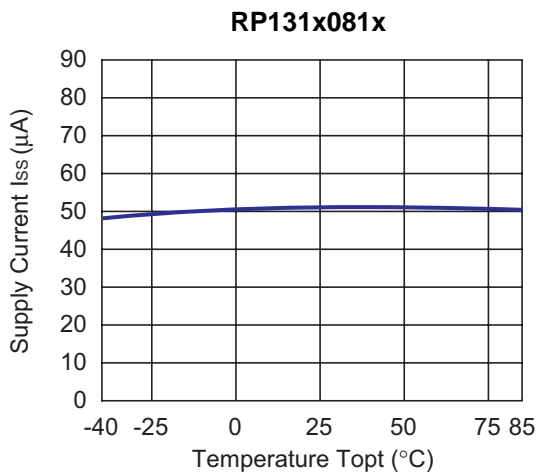

RP131x331x



RP131x501x



6) Dropout Voltage vs. Output Current

RP131x081x



RP131x151x



RP131x331x



RP131x501x



RP131x

NO.EA-174-160426

7) Dropout Voltage vs. Set Output Voltage



8) Ripple Rejection vs. Input Bias Voltage ($C1=none$, $C2=Ceramic\ 1.0\mu F$, $Ripple=0.2V_{pp}$, $T_{opt}=25^{\circ}C$)



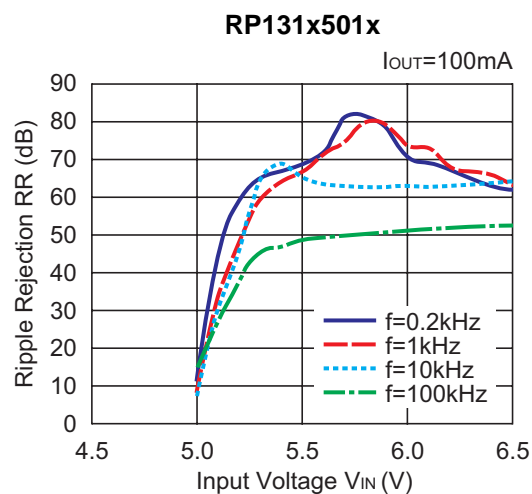

9) Ripple Rejection vs. Frequency ($C1=\text{none}$, $C2=\text{Ceramic } 4.7\mu\text{F}$, $T_{opt}=25^\circ\text{C}$)

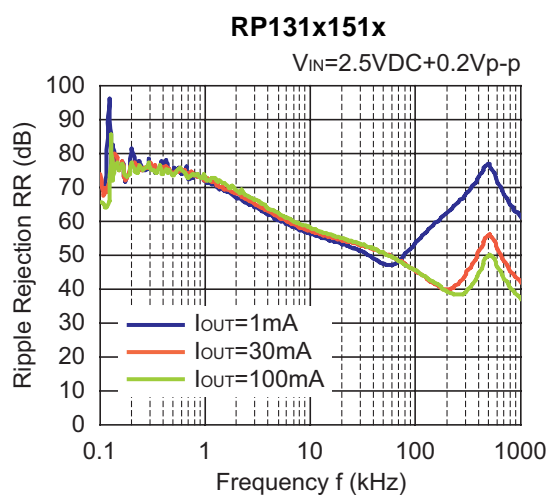
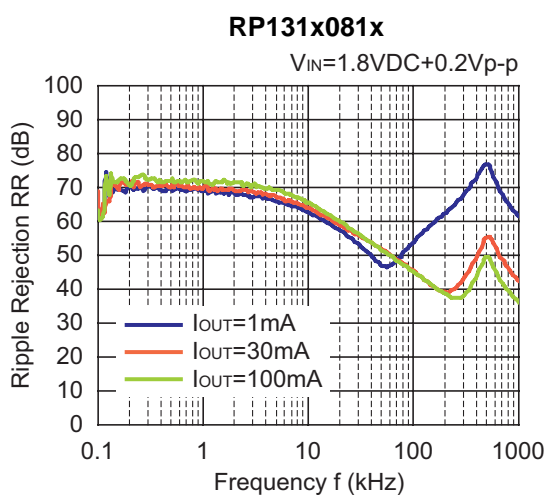

RP131x

NO.EA-174-160426

10) Input Transient Response ($I_{OUT}=100\text{mA}$, $t_r=t_f=5\mu\text{s}$, $C_1=\text{none}$, $T_{opt}=25^\circ\text{C}$)

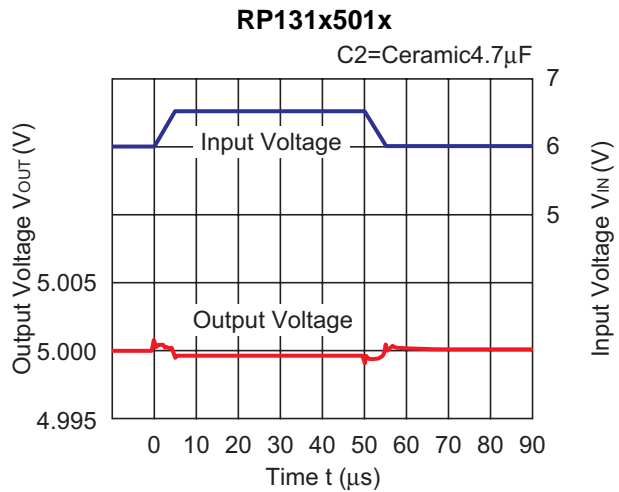
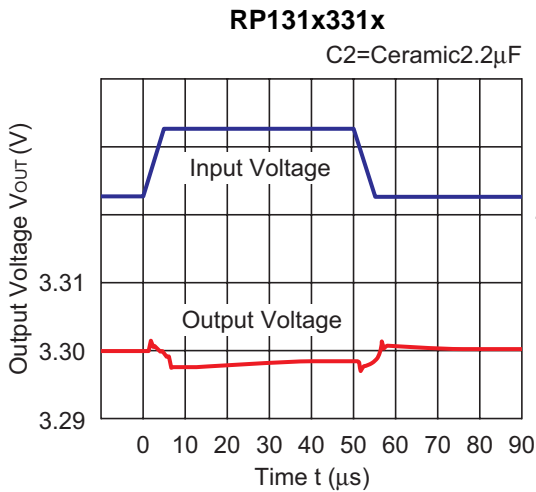
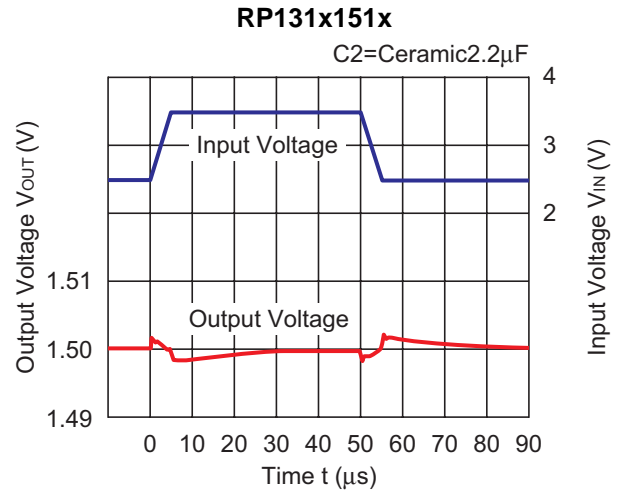
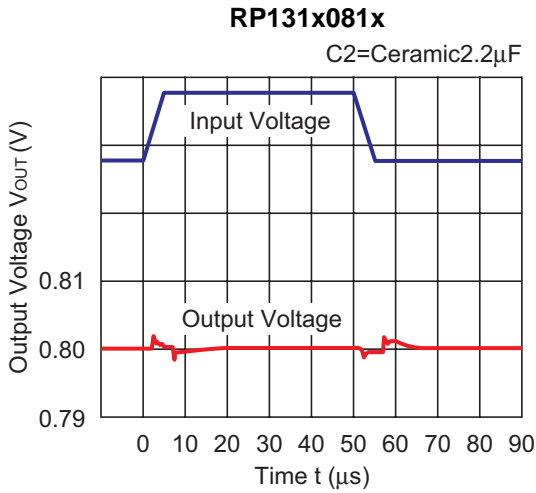

11) Load Transient Response ($t_r=t_f=0.5\mu\text{s}$, $C_1=\text{Ceramic } 2.2\mu\text{F}$, $V_{IN}=V_{OUT}+1.0\text{V}$, $T_{opt}=25^\circ\text{C}$)

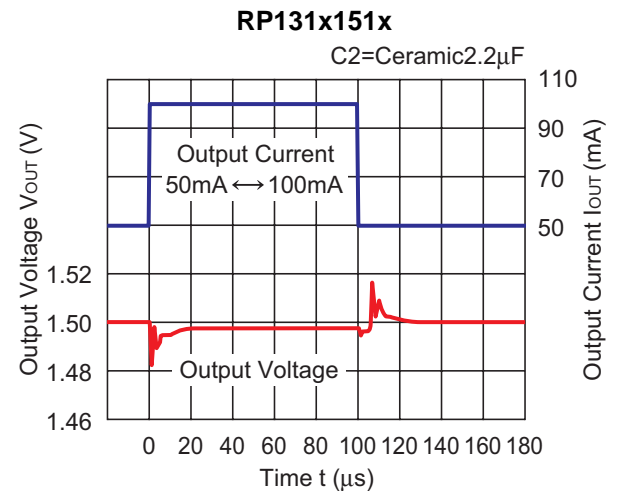
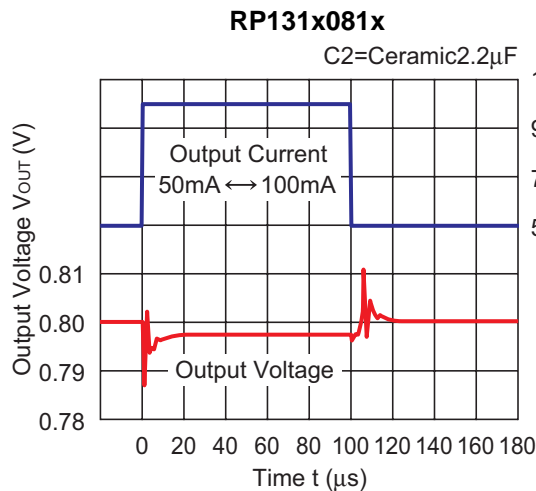

RP131x331x

C2=Ceramic4.7 μ F



RP131x501x

C2=Ceramic4.7 μ F



RP131x081x

C2=Ceramic2.2 μ F



RP131x151x

C2=Ceramic2.2 μ F



RP131x331x

C2=Ceramic4.7 μ F



RP131x501x

C2=Ceramic4.7 μ F



RP131x

NO.EA-174-160426

RP131x081x



RP131x151x



RP131x331x



RP131x501x



12) Turn On Speed with CE pin (C1=Ceramic 2.2 μ F, C2=Ceramic 4.7 μ F, T_{opt}=25°C)

RP131x081x



RP131x501x



13) Turn Off Speed with CE pin (D Version) (C1=Ceramic 2.2μF, C2=Ceramic 4.7μF, T_{opt}=25°C)



14) Inrush Current at turning on (C1=Ceramic 2.2μF, C2=Ceramic 4.7μF, T_{opt}=25°C)



15) Minimum Operating Voltage



Hatched area is available for 0.8V output.

ESR vs. Output Current

When using these ICs, consider the following points:

The relations between I_{OUT} (Output Current) and ESR of an output capacitor are shown below.

The conditions when the white noise level is under $40\mu\text{V}$ (Avg.) are marked as the hatched area in the graph.

Measurement conditions

Frequency Band : 10Hz to 3MHz

Temperature : -40°C to 85°C

C1 : $2.2\mu\text{F}$ (Kyocera, CM05X5R225M04AD)

C2 : $2.2\mu\text{F}$ (Kyocera, CM105X5R225K06AE)

$4.7\mu\text{F}$ (Kyocera, CM105X5R475M06AB)



PACKAGE INFORMATION

Power Dissipation (DFN1616-6B)

This specification is at mounted on board. Power Dissipation (P_D) depends on conditions of mounting on board. This specification is based on the measurement at the condition below:

* Measurement Conditions

	Standard Test Land Pattern
Environment	Mounting on Board (Wind velocity=0m/s)
Board Material	Glass cloth epoxy plastic (Double-sided)
Board Dimensions	40mm*40mm*1.6mm
Copper Ratio	Top side: Approx. 50%, Back side: Approx. 50%
Through-holes	ϕ 0.5mm * 32pcs

Measurement Result

($T_a=25^\circ\text{C}$)

	Standard Test Land Pattern
Power Dissipation	640mW ($T_{j\text{max}}=125^\circ\text{C}$) 820mW ($T_{j\text{max}}=150^\circ\text{C}$)
Thermal Resistance	$\theta_{ja} = (125-25^\circ\text{C})/0.64\text{W} = 156^\circ\text{C/W}$ $\theta_{jc} = 23^\circ\text{C/W}$



Power Dissipation

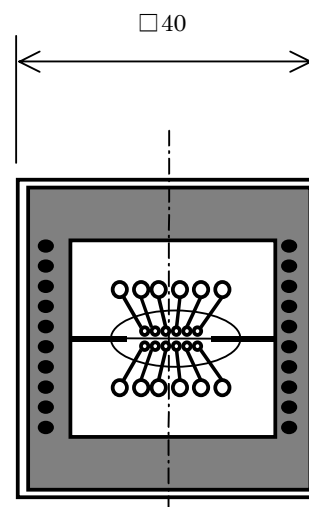

Measurement Board Pattern

IC Mount Area (Unit: mm)

The above graph shows the Power Dissipation of the package based on $T_{j\text{max}}=125^\circ\text{C}$ and $T_{j\text{max}}=150^\circ\text{C}$. Operating the IC in the shaded area in the graph might have an influence it's lifetime. Operating time must be within the time limit described in the table below, in case of operating in the shaded area.

Operating Time	Estimated years (Operating four hours/day)
13,000 hours	9years

RP131L Series Mark Specification Table

PKG: DFN1616-6B

RP131Lxx1B

Part Number	①②③④	Vset
RP131L081B	CB 01	0.8V
RP131L091B	CB 02	0.9V
RP131L101B	CB 03	1.0V
RP131L111B	CB 04	1.1V
RP131L121B	CB 05	1.2V
RP131L121B5	CB 06	1.25V
RP131L131B	CB 07	1.3V
RP131L141B	CB 08	1.4V
RP131L151B	CB 09	1.5V
RP131L161B	CB 10	1.6V
RP131L171B	CB 11	1.7V
RP131L181B	CB 12	1.8V
RP131L181B5	CB 13	1.85V
RP131L191B	CB 14	1.9V
RP131L201B	CB 15	2.0V
RP131L211B	CB 16	2.1V
RP131L221B	CB 17	2.2V
RP131L231B	CB 18	2.3V
RP131L241B	CB 19	2.4V
RP131L251B	CB 20	2.5V
RP131L261B	CB 21	2.6V
RP131L271B	CB 22	2.7V
RP131L281B	CB 23	2.8V
RP131L281B5	CB 24	2.85V
RP131L291B	CB 25	2.9V
RP131L301B	CB 26	3.0V
RP131L311B	CB 27	3.1V
RP131L321B	CB 28	3.2V
RP131L331B	CB 29	3.3V
RP131L341B	CB 30	3.4V
RP131L351B	CB 31	3.5V
RP131L361B	CB 32	3.6V
RP131L371B	CB 33	3.7V
RP131L381B	CB 34	3.8V
RP131L391B	CB 35	3.9V
RP131L401B	CB 36	4.0V
RP131L411B	CB 37	4.1V
RP131L421B	CB 38	4.2V
RP131L431B	CB 39	4.3V
RP131L441B	CB 40	4.4V
RP131L451B	CB 41	4.5V
RP131L461B	CB 42	4.6V
RP131L471B	CB 43	4.7V
RP131L481B	CB 44	4.8V
RP131L491B	CB 45	4.9V
RP131L501B	CB 46	5.0V
RP131L101B5	CB 47	1.05V
RP131L511B	CB 48	5.1V
RP131L521B	CB 49	5.2V
RP131L531B	CB 50	5.3V
RP131L541B	CB 51	5.4V
RP131L551B	CB 52	5.5V

RP131Lxx1D

Part Number	①②③④	Vset
RP131L081D	CC 01	0.8V
RP131L091D	CC 02	0.9V
RP131L101D	CC 03	1.0V
RP131L111D	CC 04	1.1V
RP131L121D	CC 05	1.2V
RP131L121D5	CC 06	1.25V
RP131L131D	CC 07	1.3V
RP131L141D	CC 08	1.4V
RP131L151D	CC 09	1.5V
RP131L161D	CC 10	1.6V
RP131L171D	CC 11	1.7V
RP131L181D	CC 12	1.8V
RP131L181D5	CC 13	1.85V
RP131L191D	CC 14	1.9V
RP131L201D	CC 15	2.0V
RP131L211D	CC 16	2.1V
RP131L221D	CC 17	2.2V
RP131L231D	CC 18	2.3V
RP131L241D	CC 19	2.4V
RP131L251D	CC 20	2.5V
RP131L261D	CC 21	2.6V
RP131L271D	CC 22	2.7V
RP131L281D	CC 23	2.8V
RP131L281D5	CC 24	2.85V
RP131L291D	CC 25	2.9V
RP131L301D	CC 26	3.0V
RP131L311D	CC 27	3.1V
RP131L321D	CC 28	3.2V
RP131L331D	CC 29	3.3V
RP131L341D	CC 30	3.4V
RP131L351D	CC 31	3.5V
RP131L361D	CC 32	3.6V
RP131L371D	CC 33	3.7V
RP131L381D	CC 34	3.8V
RP131L391D	CC 35	3.9V
RP131L401D	CC 36	4.0V
RP131L411D	CC 37	4.1V
RP131L421D	CC 38	4.2V
RP131L431D	CC 39	4.3V
RP131L441D	CC 40	4.4V
RP131L451D	CC 41	4.5V
RP131L461D	CC 42	4.6V
RP131L471D	CC 43	4.7V
RP131L481D	CC 44	4.8V
RP131L491D	CC 45	4.9V
RP131L501D	CC 46	5.0V
RP131L101D5	CC 47	1.05V
RP131L511D	CC 48	5.1V
RP131L521D	CC 49	5.2V
RP131L531D	CC 50	5.3V
RP131L541D	CC 51	5.4V
RP131L551D	CC 52	5.5V

RP131x

NO.EA-174-160426

Power Dissipation (DFN(PLP)1820-6)

This specification is at mounted on board. Power Dissipation (P_D) depends on conditions of mounting on board. This specification is based on the measurement at the condition below:

Measurement Conditions

	Standard Land Pattern
Environment	Mounting on Board (Wind velocity=0m/s)
Board Material	Glass cloth epoxy plastic (Double-sided)
Board Dimensions	40mm * 40mm * 1.6mm
Copper Ratio	Top side: Approx. 50%, Back side: Approx. 50%
Through-hole	$\phi 0.54\text{mm} * 30\text{pcs}$

Measurement Result

($T_a=25^\circ\text{C}$)

	Standard Land Pattern
Power Dissipation	880mW($T_{j\text{max}}=125^\circ\text{C}$) 1100mW($T_{j\text{max}}=150^\circ\text{C}$)
Thermal Resistance	$\theta_{ja}=(125 - 25^\circ\text{C})/0.88\text{W}=114^\circ\text{C/W}$



Measurement Board Pattern

○ IC Mount Area Unit: mm

- The above graph shows the Power Dissipation of the package based on $T_{j\text{max}}=125^\circ\text{C}$ and $T_{j\text{max}}=150^\circ\text{C}$. Operating the IC in the shaded area in the graph might have an influence it's lifetime.

Operating time must be within the time limit described in the table below, in case of operating in the shaded area.

Operating Time	Estimated years (Operating four hours/day)
13,000 hours	9years

Package Dimensions (DFN(PLP)1820-6)



*) Tab is GND level. (They are connected to the reverse side of this IC.)
 The tab is better to be connected to the GND, but leaving it open is also acceptable.

Mark Specifications (DFN(PLP)1820-6)

①②③④ : Product Code ... Refer to RP131K Series Mark Specification Table.

⑤⑥ : Lot Number ... Alphanumeric Serial Number



RP131K Series Mark Specification Table

PKG: DFN(PLP)1820-6

RP131Kxx1B

Part Number	①②③④	Vset
RP131K081B	AM 01	0.8V
RP131K091B	AM 02	0.9V
RP131K101B	AM 03	1.0V
RP131K111B	AM 04	1.1V
RP131K121B	AM 05	1.2V
RP131K121B5	AM 06	1.25V
RP131K131B	AM 07	1.3V
RP131K141B	AM 08	1.4V
RP131K151B	AM 09	1.5V
RP131K161B	AM 10	1.6V
RP131K171B	AM 11	1.7V
RP131K181B	AM 12	1.8V
RP131K181B5	AM 13	1.85V
RP131K191B	AM 14	1.9V
RP131K201B	AM 15	2.0V
RP131K211B	AM 16	2.1V
RP131K221B	AM 17	2.2V
RP131K231B	AM 18	2.3V
RP131K241B	AM 19	2.4V
RP131K251B	AM 20	2.5V
RP131K261B	AM 21	2.6V
RP131K271B	AM 22	2.7V
RP131K281B	AM 23	2.8V
RP131K281B5	AM 24	2.85V
RP131K291B	AM 25	2.9V
RP131K301B	AM 26	3.0V
RP131K311B	AM 27	3.1V
RP131K321B	AM 28	3.2V
RP131K331B	AM 29	3.3V
RP131K341B	AM 30	3.4V
RP131K351B	AM 31	3.5V
RP131K361B	AM 32	3.6V
RP131K371B	AM 33	3.7V
RP131K381B	AM 34	3.8V
RP131K391B	AM 35	3.9V
RP131K401B	AM 36	4.0V
RP131K411B	AM 37	4.1V
RP131K421B	AM 38	4.2V
RP131K431B	AM 39	4.3V
RP131K441B	AM 40	4.4V
RP131K451B	AM 41	4.5V
RP131K461B	AM 42	4.6V
RP131K471B	AM 43	4.7V
RP131K481B	AM 44	4.8V
RP131K491B	AM 45	4.9V
RP131K501B	AM 46	5.0V
RP131K101B5	AM 47	1.05V
RP131K551B	AM 48	5.5V
RP131K511B	AM 49	5.1V
RP131K521B	AM 50	5.2V
RP131K531B	AM 51	5.3V
RP131K541B	AM 52	5.4V

RP131Kxx1D

Part Number	①②③④	Vset
RP131K081D	AN 01	0.8V
RP131K091D	AN 02	0.9V
RP131K101D	AN 03	1.0V
RP131K111D	AN 04	1.1V
RP131K121D	AN 05	1.2V
RP131K121D5	AN 06	1.25V
RP131K131D	AN 07	1.3V
RP131K141D	AN 08	1.4V
RP131K151D	AN 09	1.5V
RP131K161D	AN 10	1.6V
RP131K171D	AN 11	1.7V
RP131K181D	AN 12	1.8V
RP131K181D5	AN 13	1.85V
RP131K191D	AN 14	1.9V
RP131K201D	AN 15	2.0V
RP131K211D	AN 16	2.1V
RP131K221D	AN 17	2.2V
RP131K231D	AN 18	2.3V
RP131K241D	AN 19	2.4V
RP131K251D	AN 20	2.5V
RP131K261D	AN 21	2.6V
RP131K271D	AN 22	2.7V
RP131K281D	AN 23	2.8V
RP131K281D5	AN 24	2.85V
RP131K291D	AN 25	2.9V
RP131K301D	AN 26	3.0V
RP131K311D	AN 27	3.1V
RP131K321D	AN 28	3.2V
RP131K331D	AN 29	3.3V
RP131K341D	AN 30	3.4V
RP131K351D	AN 31	3.5V
RP131K361D	AN 32	3.6V
RP131K371D	AN 33	3.7V
RP131K381D	AN 34	3.8V
RP131K391D	AN 35	3.9V
RP131K401D	AN 36	4.0V
RP131K411D	AN 37	4.1V
RP131K421D	AN 38	4.2V
RP131K431D	AN 39	4.3V
RP131K441D	AN 40	4.4V
RP131K451D	AN 41	4.5V
RP131K461D	AN 42	4.6V
RP131K471D	AN 43	4.7V
RP131K481D	AN 44	4.8V
RP131K491D	AN 45	4.9V
RP131K501D	AN 46	5.0V
RP131K101D5	AN 47	1.05V
RP131K551D	AN 48	5.5V
RP131K511D	AN 49	5.1V
RP131K521D	AN 50	5.2V
RP131K531D	AN 51	5.3V
RP131K541D	AN 52	5.4V

Power Dissipation (SOT-89-5)

This specification is at mounted on board. Power Dissipation (P_D) depends on conditions of mounting on board. This specification is based on the measurement at the condition below:

Measurement Conditions

	High Wattage Land Pattern	Standard Land Pattern
Environment	Mounting on Board (Wind velocity=0m/s)	Mounting on Board (Wind velocity=0m/s)
Board Material	Glass cloth epoxy plastic (Double-sided)	Glass cloth epoxy plastic (Double-sided)
Board Dimensions	30mm * 30mm * 1.6mm	50mm * 50mm * 1.6mm
Copper Ratio	Top side: Approx. 20% Back side: Approx. 100%	Top side: Approx. 10% Back side: Approx. 100%
Through-hole	ϕ 0.85mm * 10pcs	-

Measurement Result

($T_a=25^\circ\text{C}$)

	High Wattage Land Pattern	Standard Land Pattern	Free Air
Power Dissipation	1300mW	900mW ($T_{jmax}=125^\circ\text{C}$) 1125mW ($T_{jmax}=150^\circ\text{C}$)	500mW
Thermal Resistance	77°C/W	111°C/W	200°C/W

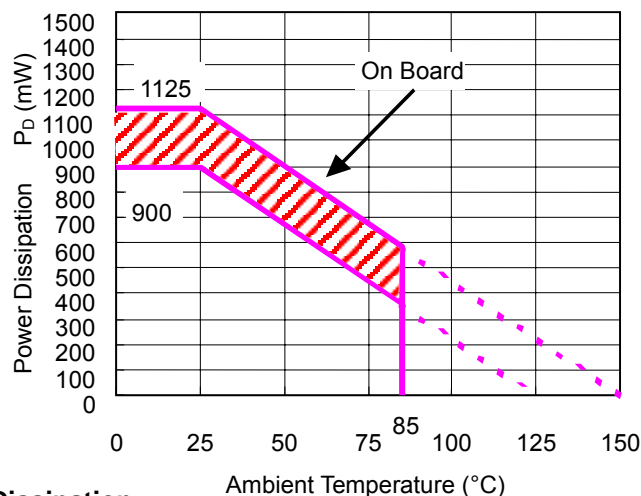

Power Dissipation



Measurement Board Pattern

○ IC Mount Area Unit: mm

- The above graph shows the Power Dissipation of the package based on $T_{jmax}=125^\circ\text{C}$ and $T_{jmax}=150^\circ\text{C}$.

Operating the IC in the shaded area in the graph might have an influence it's lifetime.

Operating time must be within the time limit described in the table below, in case of operating in the shaded area.

Operating Time	Estimated years (Operating four hours/day)
4,500 hours	3years

RP131x

NO.EA-174-160426

Package Dimensions (SOT-89-5)

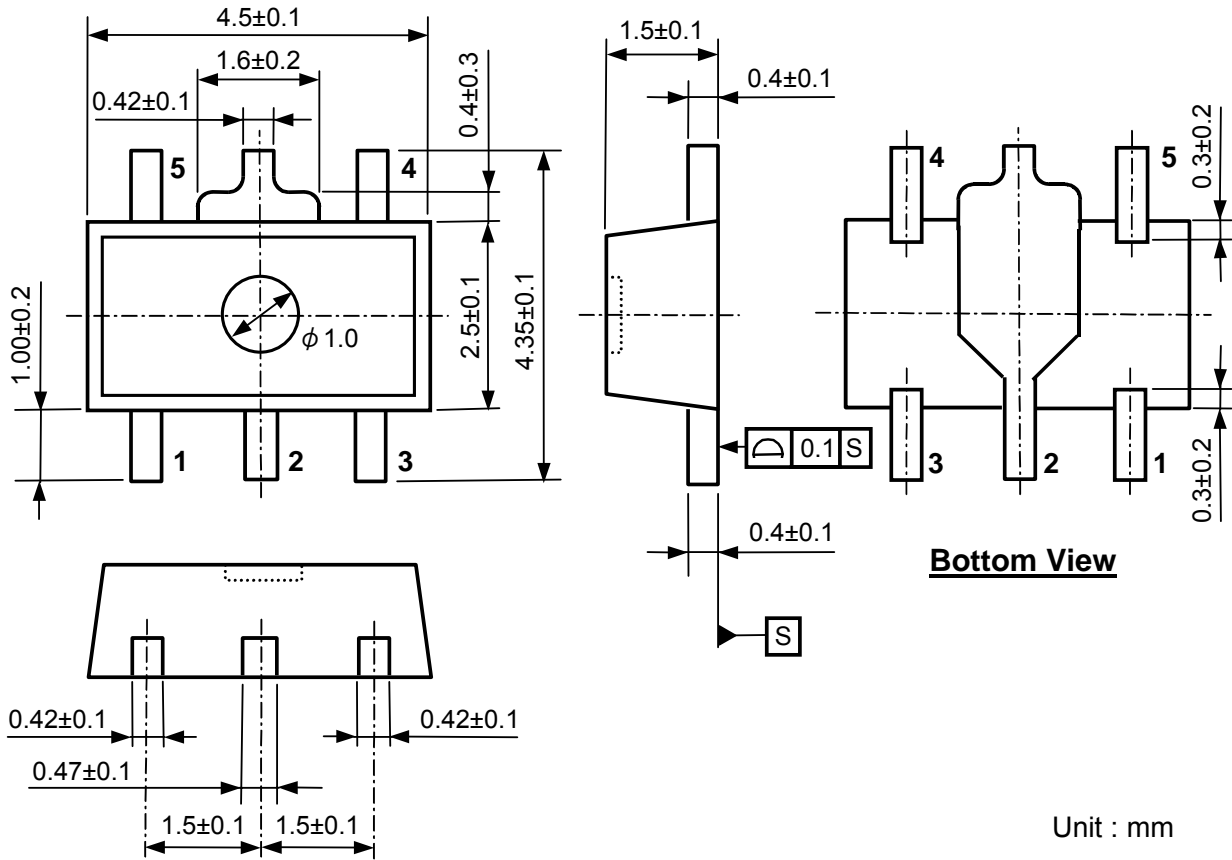

Mark Specifications (SOT-89-5)

①②③④: Product Code ... Refer to RP131H Series Mark Specification Table.

⑤⑥: Lot Number ... Alphanumeric Serial Number

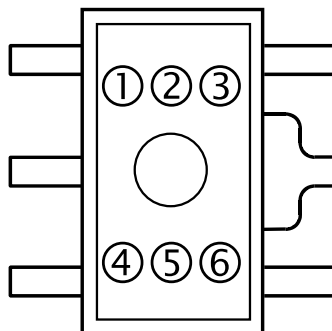

RP131H Series Mark Specification Table

PKG: SOT-89-5

RP131Hxx1B

Part Number	①②③④	Vset
RP131H081B	U 0 8 B	0.8V
RP131H091B	U 0 9 B	0.9V
RP131H101B	U 1 0 B	1.0V
RP131H111B	U 1 1 B	1.1V
RP131H121B	U 1 2 B	1.2V
RP131H131B	U 1 3 B	1.3V
RP131H141B	U 1 4 B	1.4V
RP131H151B	U 1 5 B	1.5V
RP131H161B	U 1 6 B	1.6V
RP131H171B	U 1 7 B	1.7V
RP131H181B	U 1 8 B	1.8V
RP131H191B	U 1 9 B	1.9V
RP131H201B	U 2 0 B	2.0V
RP131H211B	U 2 1 B	2.1V
RP131H221B	U 2 2 B	2.2V
RP131H231B	U 2 3 B	2.3V
RP131H241B	U 2 4 B	2.4V
RP131H251B	U 2 5 B	2.5V
RP131H261B	U 2 6 B	2.6V
RP131H271B	U 2 7 B	2.7V
RP131H281B	U 2 8 B	2.8V
RP131H291B	U 2 9 B	2.9V
RP131H301B	U 3 0 B	3.0V
RP131H311B	U 3 1 B	3.1V
RP131H321B	U 3 2 B	3.2V
RP131H331B	U 3 3 B	3.3V
RP131H341B	U 3 4 B	3.4V
RP131H351B	U 3 5 B	3.5V
RP131H361B	U 3 6 B	3.6V
RP131H371B	U 3 7 B	3.7V
RP131H381B	U 3 8 B	3.8V
RP131H391B	U 3 9 B	3.9V
RP131H401B	U 4 0 B	4.0V
RP131H411B	U 4 1 B	4.1V
RP131H421B	U 4 2 B	4.2V
RP131H431B	U 4 3 B	4.3V
RP131H441B	U 4 4 B	4.4V
RP131H451B	U 4 5 B	4.5V
RP131H461B	U 4 6 B	4.6V
RP131H471B	U 4 7 B	4.7V
RP131H481B	U 4 8 B	4.8V
RP131H491B	U 4 9 B	4.9V
RP131H501B	U 5 0 B	5.0V
RP131H511B	U 5 1 B	5.1V
RP131H521B	U 5 2 B	5.2V
RP131H531B	U 5 3 B	5.3V
RP131H541B	U 5 4 B	5.4V
RP131H551B	U 5 5 B	5.5V
RP131H121B5	U 0 1 B	1.25V
RP131H181B5	U 0 2 B	1.85V
RP131H281B5	U 0 3 B	2.85V
RP131H101B5	U 0 4 B	1.05V

RP131Hxx1D

Part Number	①②③④	Vset
RP131H081D	U 0 8 D	0.8V
RP131H091D	U 0 9 D	0.9V
RP131H101D	U 1 0 D	1.0V
RP131H111D	U 1 1 D	1.1V
RP131H121D	U 1 2 D	1.2V
RP131H131D	U 1 3 D	1.3V
RP131H141D	U 1 4 D	1.4V
RP131H151D	U 1 5 D	1.5V
RP131H161D	U 1 6 D	1.6V
RP131H171D	U 1 7 D	1.7V
RP131H181D	U 1 8 D	1.8V
RP131H191D	U 1 9 D	1.9V
RP131H201D	U 2 0 D	2.0V
RP131H211D	U 2 1 D	2.1V
RP131H221D	U 2 2 D	2.2V
RP131H231D	U 2 3 D	2.3V
RP131H241D	U 2 4 D	2.4V
RP131H251D	U 2 5 D	2.5V
RP131H261D	U 2 6 D	2.6V
RP131H271D	U 2 7 D	2.7V
RP131H281D	U 2 8 D	2.8V
RP131H291D	U 2 9 D	2.9V
RP131H301D	U 3 0 D	3.0V
RP131H311D	U 3 1 D	3.1V
RP131H321D	U 3 2 D	3.2V
RP131H331D	U 3 3 D	3.3V
RP131H341D	U 3 4 D	3.4V
RP131H351D	U 3 5 D	3.5V
RP131H361D	U 3 6 D	3.6V
RP131H371D	U 3 7 D	3.7V
RP131H381D	U 3 8 D	3.8V
RP131H391D	U 3 9 D	3.9V
RP131H401D	U 4 0 D	4.0V
RP131H411D	U 4 1 D	4.1V
RP131H421D	U 4 2 D	4.2V
RP131H431D	U 4 3 D	4.3V
RP131H441D	U 4 4 D	4.4V
RP131H451D	U 4 5 D	4.5V
RP131H461D	U 4 6 D	4.6V
RP131H471D	U 4 7 D	4.7V
RP131H481D	U 4 8 D	4.8V
RP131H491D	U 4 9 D	4.9V
RP131H501D	U 5 0 D	5.0V
RP131H511D	U 5 1 D	5.1V
RP131H521D	U 5 2 D	5.2V
RP131H531D	U 5 3 D	5.3V
RP131H541D	U 5 4 D	5.4V
RP131H551D	U 5 5 D	5.5V
RP131H121D5	U 0 1 D	1.25V
RP131H181D5	U 0 2 D	1.85V
RP131H281D5	U 0 3 D	2.85V
RP131H101D5	U 0 4 D	1.05V

RP131x

NO.EA-174-160426

Power Dissipation (HSOP-6J)

This specification is at mounted on board. Power Dissipation (P_D) depends on conditions of mounting on board. This specification is based on the measurement at the condition below:

Measurement Conditions

	High Wattage Land Pattern	Standard Land Pattern
Environment	Mounting on Board (Wind velocity=0m/s)	Mounting on Board (Wind velocity=0m/s)
Board Material	Glass cloth epoxy plastic (Double-sided)	Glass cloth epoxy plastic (Double-sided)
Board Dimensions	50mm * 50mm * 1.6mm	50mm * 50mm * 1.6mm
Copper Ratio	90%	50%
Through-hole	$\phi 0.5\text{mm} * 44\text{pcs}$	$\phi 0.5\text{mm} * 44\text{pcs}$

Measurement Result

($T_a=25^\circ\text{C}$)

	High Wattage Land Pattern	Standard Land Pattern	Free Air
Power Dissipation	2000mW	1700mW ($T_{j\text{max}}=125^\circ\text{C}$) 2125mW ($T_{j\text{max}}=150^\circ\text{C}$)	540mW
Thermal Resistance	50°C/W	59°C/W	185°C/W



Power Dissipation



High Wattage

Standard

Measurement Board Pattern

○ IC Mount Area Unit: mm

- The above graph shows the Power Dissipation of the package based on $T_{j\text{max}}=125^\circ\text{C}$ and $T_{j\text{max}}=150^\circ\text{C}$. Operating the IC in the shaded area in the graph might have an influence its lifetime. Operating time must be within the time limit described in the table below, in case of operating in the shaded area.

Operating Time
1,500 hours

Package Dimensions (HSOP-6J)



Mark Specifications (HSOP-6J)

①②③④: Product Code ... Refer to RP131S Series Mark Specification Table.

⑤⑥: Lot Number ... Alphanumeric Serial Number



RP131S Series Mark Specification Table

PKG: HSOP-6J

RP131Sxx1B

Part Number	①②③④	Vset
RP131S081B	G 0 8 B	0.8V
RP131S091B	G 0 9 B	0.9V
RP131S101B	G 1 0 B	1.0V
RP131S111B	G 1 1 B	1.1V
RP131S121B	G 1 2 B	1.2V
RP131S131B	G 1 3 B	1.3V
RP131S141B	G 1 4 B	1.4V
RP131S151B	G 1 5 B	1.5V
RP131S161B	G 1 6 B	1.6V
RP131S171B	G 1 7 B	1.7V
RP131S181B	G 1 8 B	1.8V
RP131S191B	G 1 9 B	1.9V
RP131S201B	G 2 0 B	2.0V
RP131S211B	G 2 1 B	2.1V
RP131S221B	G 2 2 B	2.2V
RP131S231B	G 2 3 B	2.3V
RP131S241B	G 2 4 B	2.4V
RP131S251B	G 2 5 B	2.5V
RP131S261B	G 2 6 B	2.6V
RP131S271B	G 2 7 B	2.7V
RP131S281B	G 2 8 B	2.8V
RP131S291B	G 2 9 B	2.9V
RP131S301B	G 3 0 B	3.0V
RP131S311B	G 3 1 B	3.1V
RP131S321B	G 3 2 B	3.2V
RP131S331B	G 3 3 B	3.3V
RP131S341B	G 3 4 B	3.4V
RP131S351B	G 3 5 B	3.5V
RP131S361B	G 3 6 B	3.6V
RP131S371B	G 3 7 B	3.7V
RP131S381B	G 3 8 B	3.8V
RP131S391B	G 3 9 B	3.9V
RP131S401B	G 4 0 B	4.0V
RP131S411B	G 4 1 B	4.1V
RP131S421B	G 4 2 B	4.2V
RP131S431B	G 4 3 B	4.3V
RP131S441B	G 4 4 B	4.4V
RP131S451B	G 4 5 B	4.5V
RP131S461B	G 4 6 B	4.6V
RP131S471B	G 4 7 B	4.7V
RP131S481B	G 4 8 B	4.8V
RP131S491B	G 4 9 B	4.9V
RP131S501B	G 5 0 B	5.0V
RP131S511B	G 5 1 B	5.1V
RP131S521B	G 5 2 B	5.2V
RP131S531B	G 5 3 B	5.3V
RP131S541B	G 5 4 B	5.4V
RP131S551B	G 5 5 B	5.5V
RP131S121B5	G 0 1 B	1.25V
RP131S181B5	G 0 2 B	1.85V
RP131S281B5	G 0 3 B	2.85V
RP131S101B5	G 0 4 B	1.05V

RP131Sxx1D

Part Number	①②③④	Vset
RP131S081D	G 0 8 D	0.8V
RP131S091D	G 0 9 D	0.9V
RP131S101D	G 1 0 D	1.0V
RP131S111D	G 1 1 D	1.1V
RP131S121D	G 1 2 D	1.2V
RP131S131D	G 1 3 D	1.3V
RP131S141D	G 1 4 D	1.4V
RP131S151D	G 1 5 D	1.5V
RP131S161D	G 1 6 D	1.6V
RP131S171D	G 1 7 D	1.7V
RP131S181D	G 1 8 D	1.8V
RP131S191D	G 1 9 D	1.9V
RP131S201D	G 2 0 D	2.0V
RP131S211D	G 2 1 D	2.1V
RP131S221D	G 2 2 D	2.2V
RP131S231D	G 2 3 D	2.3V
RP131S241D	G 2 4 D	2.4V
RP131S251D	G 2 5 D	2.5V
RP131S261D	G 2 6 D	2.6V
RP131S271D	G 2 7 D	2.7V
RP131S281D	G 2 8 D	2.8V
RP131S291D	G 2 9 D	2.9V
RP131S301D	G 3 0 D	3.0V
RP131S311D	G 3 1 D	3.1V
RP131S321D	G 3 2 D	3.2V
RP131S331D	G 3 3 D	3.3V
RP131S341D	G 3 4 D	3.4V
RP131S351D	G 3 5 D	3.5V
RP131S361D	G 3 6 D	3.6V
RP131S371D	G 3 7 D	3.7V
RP131S381D	G 3 8 D	3.8V
RP131S391D	G 3 9 D	3.9V
RP131S401D	G 4 0 D	4.0V
RP131S411D	G 4 1 D	4.1V
RP131S421D	G 4 2 D	4.2V
RP131S431D	G 4 3 D	4.3V
RP131S441D	G 4 4 D	4.4V
RP131S451D	G 4 5 D	4.5V
RP131S461D	G 4 6 D	4.6V
RP131S471D	G 4 7 D	4.7V
RP131S481D	G 4 8 D	4.8V
RP131S491D	G 4 9 D	4.9V
RP131S501D	G 5 0 D	5.0V
RP131S511D	G 5 1 D	5.1V
RP131S521D	G 5 2 D	5.2V
RP131S531D	G 5 3 D	5.3V
RP131S541D	G 5 4 D	5.4V
RP131S551D	G 5 5 D	5.5V
RP131S121D5	G 0 1 D	1.25V
RP131S181D5	G 0 2 D	1.85V
RP131S281D5	G 0 3 D	2.85V
RP131S101D5	G 0 4 D	1.05V

Power Dissipation (TO-252-5-P2)

This specification is at mounted on board. Power Dissipation (P_D) depends on conditions of mounting on board. This specification is based on the measurement at the condition below:

Measurement conditions

	Land Pattern A	Land Pattern B
Environment	Mounting on board (Wind velocity 0m/s)	Mounting on board (Wind velocity 0m/s)
Board Material	Glass cloth epoxy plastic (Double-layers)	Glass cloth epoxy plastic (Four-layers)
Board Dimensions	50mm * 50mm * 1.6mm	76.2mm * 114.3mm * 0.8mm
Copper Ratio	Top side: Approx. 50%, Back side: Approx. 50%	Top, Back side: Approx. 96%, 2nd, 3rd: 100%
Through - hole	ϕ 0.5mm * 24pcs	ϕ 0.4mm * 30pcs

Measurement Results

($T_a=25^\circ\text{C}$)

	Land pattern A	Land pattern B
Power Dissipation	1900mW ($T_{jmax}=125^\circ\text{C}$) 2375mW ($T_{jmax}=150^\circ\text{C}$)	3800mW ($T_{jmax}=125^\circ\text{C}$) 4750mW ($T_{jmax}=150^\circ\text{C}$)
Thermal Resistance	$\theta_{ja}=(125-25^\circ\text{C})/1.9\text{W}= 53^\circ\text{C/W}$ $\theta_{jc}= 17^\circ\text{C/W}$	$\theta_{ja}= (125-25^\circ\text{C})/3.8\text{W} = 26^\circ\text{C/W}$ $\theta_{jc}= 7^\circ\text{C/W}$



- The above graph shows the Power Dissipation of the package based on $T_{jmax}=125^\circ\text{C}$ and $T_{jmax}=150^\circ\text{C}$. Operating the IC in the shaded area in the graph might have an influence it's lifetime. Operating time must be within the time limit described in the table below, in case of operating in the shaded area.

Operating Time	Estimated years (Operating four hours/day)
13,000 hours	9years

Measurent Board Pattern
○ IC Mount Area Unit : mm

Measurent Board Pattern
○ IC Mount Area Unit : mm

RP131x

NO.EA-174-160426

Package Dimensions (TO-252-5-P2)



(Unit: mm)

Mark Specifications (TO-252-5-P2)

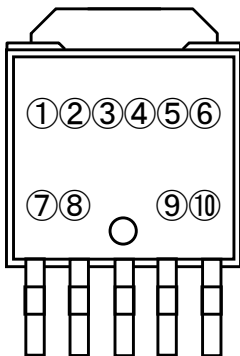

① ② ③ ④ ⑤ ⑥ ⑦ ⑧ : Refer to RP131J Series Mark Specification Table.

⑨ ⑩ : Lot Number ... Alphanumeric Serial Number

RP131J Series Mark Specification Table

PKG: TO-252-5

RP131Jxx1B

Part Number	①②③④⑤⑥⑦⑧	Vset
RP131J081B	D 1 J 0 8 1 B	0.8V
RP131J091B	D 1 J 0 9 1 B	0.9V
RP131J101B	D 1 J 1 0 1 B	1.0V
RP131J111B	D 1 J 1 1 1 B	1.1V
RP131J121B	D 1 J 1 2 1 B	1.2V
RP131J131B	D 1 J 1 3 1 B	1.3V
RP131J141B	D 1 J 1 4 1 B	1.4V
RP131J151B	D 1 J 1 5 1 B	1.5V
RP131J161B	D 1 J 1 6 1 B	1.6V
RP131J171B	D 1 J 1 7 1 B	1.7V
RP131J181B	D 1 J 1 8 1 B	1.8V
RP131J191B	D 1 J 1 9 1 B	1.9V
RP131J201B	D 1 J 2 0 1 B	2.0V
RP131J211B	D 1 J 2 1 1 B	2.1V
RP131J221B	D 1 J 2 2 1 B	2.2V
RP131J231B	D 1 J 2 3 1 B	2.3V
RP131J241B	D 1 J 2 4 1 B	2.4V
RP131J251B	D 1 J 2 5 1 B	2.5V
RP131J261B	D 1 J 2 6 1 B	2.6V
RP131J271B	D 1 J 2 7 1 B	2.7V
RP131J281B	D 1 J 2 8 1 B	2.8V
RP131J291B	D 1 J 2 9 1 B	2.9V
RP131J301B	D 1 J 3 0 1 B	3.0V
RP131J311B	D 1 J 3 1 1 B	3.1V
RP131J321B	D 1 J 3 2 1 B	3.2V
RP131J331B	D 1 J 3 3 1 B	3.3V
RP131J341B	D 1 J 3 4 1 B	3.4V
RP131J351B	D 1 J 3 5 1 B	3.5V
RP131J361B	D 1 J 3 6 1 B	3.6V
RP131J371B	D 1 J 3 7 1 B	3.7V
RP131J381B	D 1 J 3 8 1 B	3.8V
RP131J391B	D 1 J 3 9 1 B	3.9V
RP131J401B	D 1 J 4 0 1 B	4.0V
RP131J411B	D 1 J 4 1 1 B	4.1V
RP131J421B	D 1 J 4 2 1 B	4.2V
RP131J431B	D 1 J 4 3 1 B	4.3V
RP131J441B	D 1 J 4 4 1 B	4.4V
RP131J451B	D 1 J 4 5 1 B	4.5V
RP131J461B	D 1 J 4 6 1 B	4.6V
RP131J471B	D 1 J 4 7 1 B	4.7V
RP131J481B	D 1 J 4 8 1 B	4.8V
RP131J491B	D 1 J 4 9 1 B	4.9V
RP131J501B	D 1 J 5 0 1 B	5.0V
RP131J511B	D 1 J 5 1 1 B	5.1V
RP131J521B	D 1 J 5 2 1 B	5.2V
RP131J531B	D 1 J 5 3 1 B	5.3V
RP131J541B	D 1 J 5 4 1 B	5.4V
RP131J551B	D 1 J 5 5 1 B	5.5V
RP131J121B5	D 1 J 1 2 1 B 5	1.25V
RP131J181B5	D 1 J 1 8 1 B 5	1.85V
RP131J281B5	D 1 J 2 8 1 B 5	2.85V
RP131J101B5	D 1 J 1 0 1 B 5	1.05V

RP131Jxx1D

Part Number	①②③④⑤⑥⑦⑧	Vset
RP131J081D	D 1 J 0 8 1 D	0.8V
RP131J091D	D 1 J 0 9 1 D	0.9V
RP131J101D	D 1 J 1 0 1 D	1.0V
RP131J111D	D 1 J 1 1 1 D	1.1V
RP131J121D	D 1 J 1 2 1 D	1.2V
RP131J131D	D 1 J 1 3 1 D	1.3V
RP131J141D	D 1 J 1 4 1 D	1.4V
RP131J151D	D 1 J 1 5 1 D	1.5V
RP131J161D	D 1 J 1 6 1 D	1.6V
RP131J171D	D 1 J 1 7 1 D	1.7V
RP131J181D	D 1 J 1 8 1 D	1.8V
RP131J191D	D 1 J 1 9 1 D	1.9V
RP131J201D	D 1 J 2 0 1 D	2.0V
RP131J211D	D 1 J 2 1 1 D	2.1V
RP131J221D	D 1 J 2 2 1 D	2.2V
RP131J231D	D 1 J 2 3 1 D	2.3V
RP131J241D	D 1 J 2 4 1 D	2.4V
RP131J251D	D 1 J 2 5 1 D	2.5V
RP131J261D	D 1 J 2 6 1 D	2.6V
RP131J271D	D 1 J 2 7 1 D	2.7V
RP131J281D	D 1 J 2 8 1 D	2.8V
RP131J291D	D 1 J 2 9 1 D	2.9V
RP131J301D	D 1 J 3 0 1 D	3.0V
RP131J311D	D 1 J 3 1 1 D	3.1V
RP131J321D	D 1 J 3 2 1 D	3.2V
RP131J331D	D 1 J 3 3 1 D	3.3V
RP131J341D	D 1 J 3 4 1 D	3.4V
RP131J351D	D 1 J 3 5 1 D	3.5V
RP131J361D	D 1 J 3 6 1 D	3.6V
RP131J371D	D 1 J 3 7 1 D	3.7V
RP131J381D	D 1 J 3 8 1 D	3.8V
RP131J391D	D 1 J 3 9 1 D	3.9V
RP131J401D	D 1 J 4 0 1 D	4.0V
RP131J411D	D 1 J 4 1 1 D	4.1V
RP131J421D	D 1 J 4 2 1 D	4.2V
RP131J431D	D 1 J 4 3 1 D	4.3V
RP131J441D	D 1 J 4 4 1 D	4.4V
RP131J451D	D 1 J 4 5 1 D	4.5V
RP131J461D	D 1 J 4 6 1 D	4.6V
RP131J471D	D 1 J 4 7 1 D	4.7V
RP131J481D	D 1 J 4 8 1 D	4.8V
RP131J491D	D 1 J 4 9 1 D	4.9V
RP131J501D	D 1 J 5 0 1 D	5.0V
RP131J511D	D 1 J 5 1 1 D	5.1V
RP131J521D	D 1 J 5 2 1 D	5.2V
RP131J531D	D 1 J 5 3 1 D	5.3V
RP131J541D	D 1 J 5 4 1 D	5.4V
RP131J551D	D 1 J 5 5 1 D	5.5V
RP131J121D5	D 1 J 1 2 1 D 5	1.25V
RP131J181D5	D 1 J 1 8 1 D 5	1.85V
RP131J281D5	D 1 J 2 8 1 D 5	2.85V
RP131J101D5	D 1 J 1 0 1 D 5	1.05V



1. The products and the product specifications described in this document are subject to change or discontinuation of production without notice for reasons such as improvement. Therefore, before deciding to use the products, please refer to Ricoh sales representatives for the latest information thereon.
2. The materials in this document may not be copied or otherwise reproduced in whole or in part without prior written consent of Ricoh.
3. Please be sure to take any necessary formalities under relevant laws or regulations before exporting or otherwise taking out of your country the products or the technical information described herein.
4. The technical information described in this document shows typical characteristics of and example application circuits for the products. The release of such information is not to be construed as a warranty of or a grant of license under Ricoh's or any third party's intellectual property rights or any other rights.
5. The products listed in this document are intended and designed for use as general electronic components in standard applications (office equipment, telecommunication equipment, measuring instruments, consumer electronic products, amusement equipment etc.). Those customers intending to use a product in an application requiring extreme quality and reliability, for example, in a highly specific application where the failure or misoperation of the product could result in human injury or death (aircraft, spacevehicle, nuclear reactor control system, traffic control system, automotive and transportation equipment, combustion equipment, safety devices, life support system etc.) should first contact us.
6. We are making our continuous effort to improve the quality and reliability of our products, but semiconductor products are likely to fail with certain probability. In order to prevent any injury to persons or damages to property resulting from such failure, customers should be careful enough to incorporate safety measures in their design, such as redundancy feature, fire containment feature and fail-safe feature. We do not assume any liability or responsibility for any loss or damage arising from misuse or inappropriate use of the products.
7. Anti-radiation design is not implemented in the products described in this document.
8. Please contact Ricoh sales representatives should you have any questions or comments concerning the products or the technical information.



Ricoh is committed to reducing the environmental loading materials in electrical devices with a view to contributing to the protection of human health and the environment.

Ricoh has been providing RoHS compliant products since April 1, 2006 and Halogen-free products since April 1, 2012.

RICOH RICOH ELECTRONIC DEVICES CO., LTD.

<http://www.e-devices.ricoh.co.jp/en/>

Sales & Support Offices

RICOH ELECTRONIC DEVICES CO., LTD.

Higashi-Shinagawa Office (International Sales)
3-32-3, Higashi-Shinagawa, Shinagawa-ku, Tokyo 140-8655, Japan
Phone: +81-3-5479-2857 Fax: +81-3-5479-0502

RICOH EUROPE (NETHERLANDS) B.V.

Semiconductor Support Centre
Prof. W.H. Keesomlaan 1, 1183 DJ Amstelveen, The Netherlands
Phone: +31-20-5474-309

RICOH INTERNATIONAL B.V. - German Branch

Semiconductor Sales and Support Centre
Oberrather Strasse 6, 40472 Düsseldorf, Germany
Phone: +49-211-6546-0

RICOH ELECTRONIC DEVICES KOREA CO., LTD.

3F, Haesung Bldg, 504, Teheran-ro, Gangnam-gu, Seoul, 135-725, Korea
Phone: +82-2-2135-5700 Fax: +82-2-2051-5713

RICOH ELECTRONIC DEVICES SHANGHAI CO., LTD.

Room 403, No.2 Building, No.690 Bibo Road, Pu Dong New District, Shanghai 201203, People's Republic of China
Phone: +86-21-5027-3200 Fax: +86-21-5027-3299

RICOH ELECTRONIC DEVICES CO., LTD.

Taipei office
Room 109, 10F-1, No.51, Hengyang Rd., Taipei City, Taiwan (R.O.C.)
Phone: +886-2-2313-1621/1622 Fax: +886-2-2313-1623

Mouser Electronics

Authorized Distributor

Click to View Pricing, Inventory, Delivery & Lifecycle Information:

Ricoh Electronics:

[RP131H101D-T1-FE](#) [RP131S331D-E2-FE](#) [RP131S331B-E2-FE](#) [RP131H181D-T1-FE](#) [RP131H181B-T1-FE](#)
[RP131H501B-T1-FE](#) [RP131S151B-E2-FE](#) [RP131S101B-E2-FE](#) [RP131S301D-E2-FE](#) [RP131J151D-T1-FE](#)
[RP131H451D-T1-FE](#) [RP131H251B-T1-FE](#) [RP131S281D-E2-FE](#) [RP131S251D-E2-FE](#) [RP131S151D-E2-FE](#)
[RP131J121D-T1-FE](#) [RP131H251D-T1-FE](#) [RP131S501D-E2-FE](#) [RP131S451D-E2-FE](#) [RP131H151D-T1-FE](#)
[RP131H331B-T1-FE](#) [RP131H121D-T1-FE](#) [RP131S101D-E2-FE](#) [RP131S121B-E2-FE](#) [RP131H121B-T1-FE](#)
[RP131H301D-T1-FE](#) [RP131S121D-E2-FE](#) [RP131H151B-T1-FE](#) [RP131H501D-T1-FE](#) [RP131H331D-T1-FE](#)
[RP131S501B-E2-FE](#) [RP131S181B-E2-FE](#) [RP131S251B-E2-FE](#) [RP131S181D-E2-FE](#)



Компания «ЭлектроПласт» предлагает заключение долгосрочных отношений при поставках импортных электронных компонентов на взаимовыгодных условиях!

Наши преимущества:

- Оперативные поставки широкого спектра электронных компонентов отечественного и импортного производства напрямую от производителей и с крупнейших мировых складов;
- Поставка более 17-ти миллионов наименований электронных компонентов;
- Поставка сложных, дефицитных, либо снятых с производства позиций;
- Оперативные сроки поставки под заказ (от 5 рабочих дней);
- Экспресс доставка в любую точку России;
- Техническая поддержка проекта, помощь в подборе аналогов, поставка прототипов;
- Система менеджмента качества сертифицирована по Международному стандарту ISO 9001;
- Лицензия ФСБ на осуществление работ с использованием сведений, составляющих государственную тайну;
- Поставка специализированных компонентов (Xilinx, Altera, Analog Devices, Intersil, Interpoint, Microsemi, Aeroflex, Peregrine, Syfer, Eurofarad, Texas Instrument, Miteq, Cobham, E2V, MA-COM, Hittite, Mini-Circuits, General Dynamics и др.);

Помимо этого, одним из направлений компании «ЭлектроПласт» является направление «Источники питания». Мы предлагаем Вам помощь Конструкторского отдела:

- Подбор оптимального решения, техническое обоснование при выборе компонента;
- Подбор аналогов;
- Консультации по применению компонента;
- Поставка образцов и прототипов;
- Техническая поддержка проекта;
- Защита от снятия компонента с производства.



Как с нами связаться

Телефон: 8 (812) 309 58 32 (многоканальный)

Факс: 8 (812) 320-02-42

Электронная почта: org@eplast1.ru

Адрес: 198099, г. Санкт-Петербург, ул. Калинина, дом 2, корпус 4, литера А.