

## LAR

Snap-in Terminal Type, 105°C Permissible Overvoltage

- Withstanding 2000 hours application of rated ripple current at 105°C.
- Reduction of short incidence when overvoltage (rated voltage x 1.5) is applied to a capacitor.
- Compliant to the RoHS directive (2011/65/EU, (EU)2015/863).



### Specifications

Item	Performance Characteristics												
Category Temperature Range	-40 to +105°C (200·250V), -25 to +105°C (400·450V)												
Rated Voltage Range	200 to 450V												
Rated Capacitance Range	82 to 2200μF												
Capacitance Tolerance	±20% at 120Hz, 20°C												
Leakage Current	$I \leq 3\sqrt{CV}$ (μA) (After 5 minutes' application of rated voltage [C: Rated Capacitance(μF), V: Voltage(V)])												
Tangent of loss angle (tan δ)	<table border="1"> <tr> <th>Rated voltage (V)</th> <th>200 to 400</th> <th>450</th> </tr> <tr> <td>tan δ (MAX.)</td> <td>0.15</td> <td>0.20</td> </tr> </table> <p>Measurement frequency : 120Hz at 20°C</p>		Rated voltage (V)	200 to 400	450	tan δ (MAX.)	0.15	0.20					
Rated voltage (V)	200 to 400	450											
tan δ (MAX.)	0.15	0.20											
Stability at Low Temperature	<table border="1"> <tr> <th colspan="2">Rated voltage(V)</th> <th>200 · 250</th> <th>400 · 450</th> </tr> <tr> <td rowspan="2">Impedance ratio</td> <td>Z - 25°C / Z+20°C</td> <td>3</td> <td>8</td> </tr> <tr> <td>ZT/Z20(MAX.)</td> <td>12</td> <td>—</td> </tr> </table> <p>Measurement frequency : 120Hz</p>		Rated voltage(V)		200 · 250	400 · 450	Impedance ratio	Z - 25°C / Z+20°C	3	8	ZT/Z20(MAX.)	12	—
Rated voltage(V)		200 · 250	400 · 450										
Impedance ratio	Z - 25°C / Z+20°C	3	8										
	ZT/Z20(MAX.)	12	—										
Endurance	The specifications listed at right shall be met when the capacitors are restored to 20°C after D.C. bias plus rated ripple current is applied for 2000 hours at 105°C, the peak voltage shall not exceed the rated voltage.	<table border="1"> <tr> <td>Capacitance change</td> <td>Within ±20% of the initial capacitance value</td> </tr> <tr> <td>tan δ</td> <td>200% or less than the initial specified value</td> </tr> <tr> <td>Leakage current</td> <td>Less than or equal to the initial specified value</td> </tr> </table>	Capacitance change	Within ±20% of the initial capacitance value	tan δ	200% or less than the initial specified value	Leakage current	Less than or equal to the initial specified value					
Capacitance change	Within ±20% of the initial capacitance value												
tan δ	200% or less than the initial specified value												
Leakage current	Less than or equal to the initial specified value												
Shelf Life	After storing the capacitors under no load at 105°C for 1000 hours and then performing voltage treatment based on JIS C 5101-4 clause 4.1 at 20°C, they shall meet the requirements listed at right.	<table border="1"> <tr> <td>Capacitance change</td> <td>Within ±15% of the initial capacitance value</td> </tr> <tr> <td>tan δ</td> <td>150% or less than the initial specified value</td> </tr> <tr> <td>Leakage current</td> <td>Less than or equal to the initial specified value</td> </tr> </table>	Capacitance change	Within ±15% of the initial capacitance value	tan δ	150% or less than the initial specified value	Leakage current	Less than or equal to the initial specified value					
Capacitance change	Within ±15% of the initial capacitance value												
tan δ	150% or less than the initial specified value												
Leakage current	Less than or equal to the initial specified value												
Safety Performance	When overvoltage (rated voltage x 1.5, limited current = 1A) is applied to a capacitor, the pressure relief vent will operate normally more than 60% of the time without short and flame.												
Marking	Printed with white color letter on black sleeve.												

### Drawing



### Type numbering system (Example : 400V 120μF)

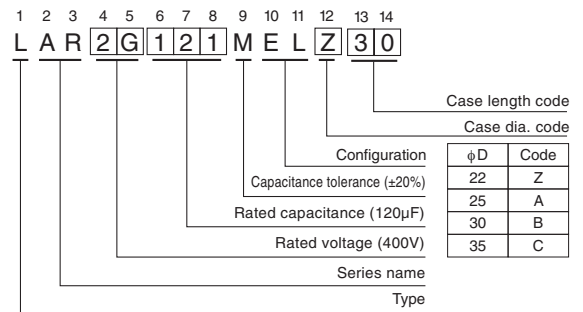

※ The other terminal is also available upon request. Please refer page 346 for schematic of dimensions.

### Frequency coefficient of rated ripple current

Frequency(Hz)	50	60	120	300	1k	10k	50k or more
coeff.	200.250V	0.81	0.85	1.00	1.17	1.32	1.50
	400.450V	0.77	0.82	1.00	1.16	1.30	1.43

Minimum order quantity : 50pcs.

● Dimension table in next page.

## LAR

### ■ Dimensions

200V (2D)				
Cap. (μF)	Size φD × L (mm)	Rated ripple (mArms)	Leakage Current (mA)	Code
390	22 × 25	1310	0.83	LAR2D391MELZ25
470	22 × 30	1480	0.91	LAR2D471MELZ30
	25 × 25	1480	0.91	LAR2D471MELA25
560	22 × 35	1600	1.00	LAR2D561MELZ35
680	22 × 40	1750	1.10	LAR2D681MELZ40
	25 × 30	1750	1.10	LAR2D681MELA30
	30 × 25	1750	1.10	LAR2D681MELB25
820	22 × 45	2040	1.21	LAR2D821MELZ45
	25 × 35	2040	1.21	LAR2D821MELA35
1000	22 × 50	2300	1.34	LAR2D102MELZ50
	25 × 45	2300	1.34	LAR2D102MELA45
	30 × 30	2300	1.34	LAR2D102MELB30
	35 × 25	2300	1.34	LAR2D102MELC25
1200	25 × 50	2650	1.46	LAR2D122MELA50
	30 × 35	2650	1.46	LAR2D122MELB35
	35 × 30	2650	1.46	LAR2D122MELC30
1500	30 × 40	2800	1.64	LAR2D152MELB40
	35 × 35	2800	1.64	LAR2D152MELC35
1800	30 × 50	3080	1.80	LAR2D182MELB50
	35 × 40	3080	1.80	LAR2D182MELC40
2200	35 × 45	3480	1.98	LAR2D222MELC45

250V (2E)				
Cap. (μF)	Size φD × L (mm)	Rated ripple (mArms)	Leakage Current (mA)	Code
270	22 × 25	1100	0.77	LAR2E271MELZ25
330	22 × 30	1200	0.86	LAR2E331MELZ30
	25 × 25	1200	0.86	LAR2E331MELA25
390	22 × 35	1300	0.93	LAR2E391MELZ35
	25 × 30	1300	0.93	LAR2E391MELA30
470	22 × 40	1400	1.02	LAR2E471MELZ40
	25 × 35	1400	1.02	LAR2E471MELA35
	30 × 25	1400	1.02	LAR2E471MELB25
560	22 × 45	1500	1.12	LAR2E561MELZ45
	25 × 35	1500	1.12	LAR2E561MELA35
	30 × 30	1500	1.12	LAR2E561MELB30
680	22 × 50	1700	1.23	LAR2E681MELZ50
	25 × 40	1700	1.23	LAR2E681MELA40
	30 × 30	1700	1.23	LAR2E681MELB30
820	35 × 25	1700	1.23	LAR2E681MELC25
	25 × 45	2000	1.35	LAR2E821MELA45
	30 × 35	2000	1.35	LAR2E821MELB35
1000	35 × 30	2000	1.35	LAR2E821MELC30
	30 × 40	2200	1.50	LAR2E102MELB40
	35 × 35	2200	1.50	LAR2E102MELC35
1200	30 × 45	2300	1.64	LAR2E122MELB45
	35 × 40	2300	1.64	LAR2E122MELC40
1500	35 × 45	2500	1.83	LAR2E152MELC45
1800	35 × 50	2700	2.01	LAR2E182MELC50

400V (2G)				
Cap. (μF)	Size φD × L (mm)	Rated ripple (mArms)	Leakage Current (mA)	Code
100	22 × 25	680	0.60	LAR2G101MELZ25
120	22 × 30	730	0.65	LAR2G121MELZ30
180	22 × 35	950	0.80	LAR2G181MELZ35
	25 × 30	950	0.80	LAR2G181MELA30
220	30 × 25	950	0.80	LAR2G181MELB25
	22 × 45	1100	0.88	LAR2G221MELZ45
270	25 × 35	1100	0.88	LAR2G221MELA35
	30 × 25	1100	0.88	LAR2G221MELB25
	22 × 50	1220	0.98	LAR2G271MELZ50
330	25 × 40	1220	0.98	LAR2G271MELA40
	30 × 30	1220	0.98	LAR2G271MELB30
	35 × 25	1220	0.98	LAR2G271MELC25
390	25 × 45	1440	1.08	LAR2G331MELA45
	30 × 35	1440	1.08	LAR2G331MELB35
470	25 × 50	1550	1.18	LAR2G391MELA50
	30 × 40	1550	1.18	LAR2G391MELB40
560	35 × 30	1550	1.18	LAR2G391MELC30
	30 × 45	1680	1.30	LAR2G471MELB45
680	35 × 35	1680	1.30	LAR2G471MELC35
	30 × 50	1900	1.41	LAR2G561MELB50
	35 × 40	1900	1.41	LAR2G561MELC40
	35 × 45	2120	1.56	LAR2G681MELC45

450V (2W)				
Cap. (μF)	Size φD × L (mm)	Rated ripple (mArms)	Leakage Current (mA)	Code
82	22 × 25	340	0.57	LAR2W820MELZ25
100	22 × 30	690	0.63	LAR2W101MELZ30
	25 × 25	690	0.63	LAR2W101MELA25
120	22 × 35	720	0.69	LAR2W121MELZ35
	25 × 30	720	0.69	LAR2W121MELA30
150	22 × 40	790	0.77	LAR2W151MELZ40
	25 × 30	790	0.77	LAR2W151MELA30
	30 × 25	790	0.77	LAR2W151MELB25
180	22 × 45	870	0.85	LAR2W181MELZ45
	25 × 35	870	0.85	LAR2W181MELA35
	30 × 30	870	0.85	LAR2W181MELB30
220	25 × 40	1050	0.94	LAR2W221MELA40
	30 × 30	1050	0.94	LAR2W221MELB30
	35 × 25	1050	0.94	LAR2W221MELC25
270	25 × 50	1230	1.04	LAR2W271MELA50
	30 × 35	1230	1.04	LAR2W271MELB35
	35 × 30	1230	1.04	LAR2W271MELC30
330	30 × 40	1380	1.15	LAR2W331MELB40
	35 × 35	1380	1.15	LAR2W331MELC35
390	30 × 50	1610	1.25	LAR2W391MELB50
	35 × 40	1610	1.25	LAR2W391MELC40
470	35 × 45	1780	1.37	LAR2W471MELC45
560	35 × 50	1990	1.50	LAR2W561MELC50

Rated ripple current (mArms) at 105°C 120Hz



Компания «ЭлектроПласт» предлагает заключение долгосрочных отношений при поставках импортных электронных компонентов на взаимовыгодных условиях!

Наши преимущества:

- Оперативные поставки широкого спектра электронных компонентов отечественного и импортного производства напрямую от производителей и с крупнейших мировых складов;
- Поставка более 17-ти миллионов наименований электронных компонентов;
- Поставка сложных, дефицитных, либо снятых с производства позиций;
- Оперативные сроки поставки под заказ (от 5 рабочих дней);
- Экспресс доставка в любую точку России;
- Техническая поддержка проекта, помощь в подборе аналогов, поставка прототипов;
- Система менеджмента качества сертифицирована по Международному стандарту ISO 9001;
- Лицензия ФСБ на осуществление работ с использованием сведений, составляющих государственную тайну;
- Поставка специализированных компонентов (Xilinx, Altera, Analog Devices, Intersil, Interpoint, Microsemi, Aeroflex, Peregrine, Syfer, Eurofarad, Texas Instrument, Miteq, Cobham, E2V, MA-COM, Hittite, Mini-Circuits, General Dynamics и др.);

Помимо этого, одним из направлений компании «ЭлектроПласт» является направление «Источники питания». Мы предлагаем Вам помощь Конструкторского отдела:

- Подбор оптимального решения, техническое обоснование при выборе компонента;
- Подбор аналогов;
- Консультации по применению компонента;
- Поставка образцов и прототипов;
- Техническая поддержка проекта;
- Защита от снятия компонента с производства.



#### Как с нами связаться

**Телефон:** 8 (812) 309 58 32 (многоканальный)

**Факс:** 8 (812) 320-02-42

**Электронная почта:** [org@eplast1.ru](mailto:org@eplast1.ru)

**Адрес:** 198099, г. Санкт-Петербург, ул. Калинина, дом 2, корпус 4, литера А.