

Headphone Amplifier for Portable Audio

■ GENERAL DESCRIPTION

The **NJM2776** is a low voltage headphone amplifier for portable audio applications.

The **NJM2776** operates directly for one battery supply with independent power supply terminals (V^{+1} and V^{+2}).

Also it provides shock-noise less standby mode.

The **NJM2776** is suitable for portable MD, portable CD and others.

■ PACKAGE OUTLINE



NJM2776RB2
MSOP10 (TVSP10)

■ FEATURES

- Operating Voltage V^{+1} (from step-up converter) = 1.8 to 4.5V (however, $V^{+1} > V^{+2}$)
 V^{+2} (from battery) = 0.9 to 4.5V (however, $V^{+1} > V^{+2}$)
- Low Operating Current $I_{CC4}(V^{+1} \text{ side}) = 200\mu\text{A typ.}$ ($V^{+1} = 2.3\text{V}$, $V^{+2} = 1.2\text{V}$, No signal)
 $I_{CC3}(V^{+2} \text{ side}) = 350\mu\text{A typ.}$ ($V^{+1} = 2.3\text{V}$, $V^{+2} = 1.2\text{V}$, No signal)
- Supply Current in Standby mode $I_{CC2}(V^{+1} \text{ side}) = 25\mu\text{A typ.}$ ($V^{+1} = 2.3\text{V}$, $V^{+2} = 1.2\text{V}$)
 $I_{CC1}(V^{+2} \text{ side}) = 6\mu\text{A typ.}$ ($V^{+1} = 2.3\text{V}$, $V^{+2} = 1.2\text{V}$)
- Output Power Exceeds $P_O = 8.5\text{mW typ.}$ ($R_L = 16\Omega$, THD = 10%)
- Shock-noise less Standby mode
- Bipolar Technology
- Package Outline MSOP10 (TVSP10)*
*MEET JEDEC MO-187-DA / THIN TYPE

■ PIN CONFIGURATION AND BLOCK DIAGRAM

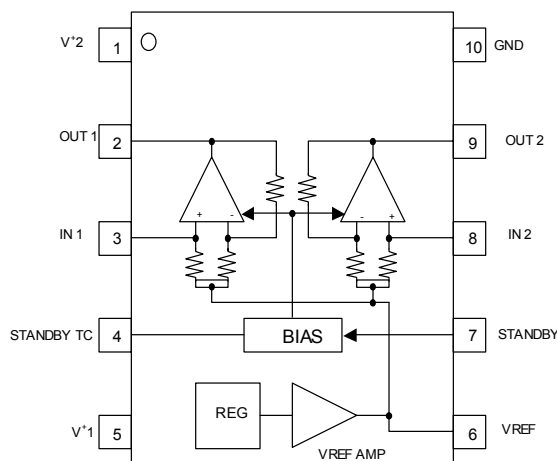

1. V^{+2}
2. OUT1
3. IN1
4. STADBY_TC
5. V^{+1}
6. VREF
7. STANDBY
8. IN2
9. OUT2
10. GND

NJM2776

■ ABSOLUTE MAXIMUM RATINGS (Ta=25°C)

PARAMETER	SYMBOL	RATINGS	UNIT
Supply Voltage	V ⁺	5	V
Power Dissipation	P _D	320 ^(note)	mW
Operating Temperature range	T _{opr}	-20 to +75	°C
Storage Temperature Range	T _{stg}	-40 to +125	°C

■ RECOMMENDED OPERATING CONDITIONS

PARAMETER	SYMBOL	TEST CONDITION	MIN.	TYP.	MAX.	UNIT
Operating Voltage Range	V ⁺¹	-	1.8	2.3	4.5	V
	V ⁺²	-	0.9	1.2	4.5	

■ ELECTRICAL CHARACTERISTICS (Ta=25°C, V⁺¹=2.3V, V⁺²=1.2V, V_{IN}=-30dBV (31.6mVrms), f=1kHz, R_L=16Ω, Active mode, unless otherwise specified)

● Power Supply

PARAMETER	SYMBOL	TEST CONDITION	pin	MIN.	TYP.	MAX.	UNIT
Operating Current	I _{CC0}	V ⁺¹ =0V	V ⁺²	-	-	1.0	μA
	I _{CC1}	Standby mode	V ⁺²	-	6.0	10.0	
	I _{CC2}		V ⁺¹	-	25	35	
	I _{CC3}	No signal	V ⁺²	-	350	750	mA
	I _{CC4}		V ⁺¹	-	200	400	
		I _{CC5}	P _O =0.1mW+0.1mW	V ⁺²	-	2.5	-
	I _{CC6}	V ⁺¹		-	200	-	
Reference Voltage	V _{REF}	No signal		0.50	0.60	0.65	V

● Amplifier

PARAMETER	SYMBOL	TEST CONDITION	MIN.	TYP.	MAX.	UNIT
Closed loop Gain	G _V		10.0	11.5	12.5	dB
Output Power	P _O	THD=10%	5.0	8.5	-	mW
Total Harmonic Distortion	THD	P _O =1mW	-	0.20	0.50	%
Output Noise Voltage	V _{NO}	A-Weighted	-	-100 (10.0)	-96 (15.8)	dBV (μV)
Channel Separation	CS		44	55	-	dB
Mute Level	MUTE	Standby mode 1kHz Band Pass	-	-100	-80	dB
Supply Voltage Rejection Ratio	PSRR1	V ⁺¹ =1.8V + 0.1Vrms V ⁺² =0.9V	46	52	-	dB
	PSRR2	V ⁺¹ =1.8V V ⁺² =0.9V + 0.1Vrms	70	77	-	

● Mode Control

PARAMETER	SYMBOL	TEST CONDITION	MIN.	TYP.	MAX.	UNIT
High Level Input Voltage	V _{IH}	V _{IN} =High Level	1.2	-	V ⁺¹	V
Low Level Input Voltage	V _{IL}	V _{IN} =Low Level	0.0	-	0.3	

■ MODE SWITCH FUNCTION

● STANDBY (7PIN)

PARAMETER	CONTROL SIGNAL	STATUS
Standby	L, open	IC is non-active.
Active	H	IC is active.

■ TERMINAL DESCRIPTION

PIN No.	SYMBOL	EQUIVALENT CIRCUIT	VOLTAGE	NOTE
2,9	OUT1, OUT2		0.6V	
3,8	IN1, IN2		0.6V	
4	STANDBY_TC		1.2V	
6	VREF		0.6V	

NJM2776

PIN No.	SYMBOL	EQUIVALENT CIRCUIT	VOLTAGE	NOTE
7	STANDBY		-	

APPLICATION CIRCUIT

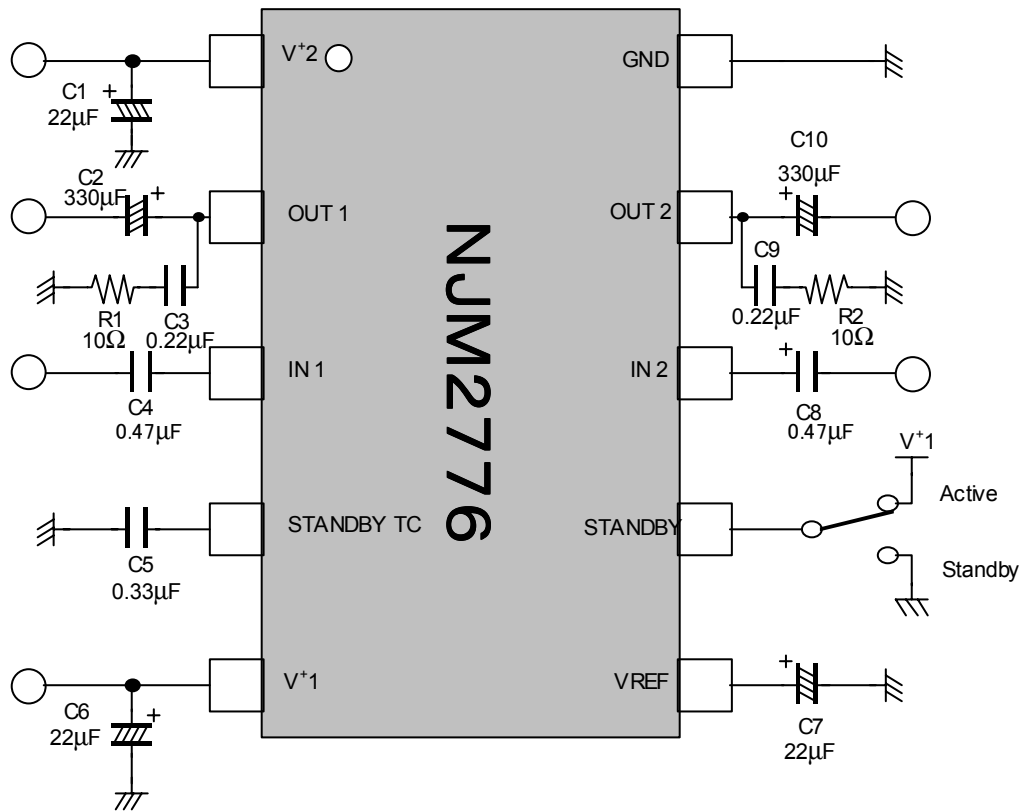

Note) Recommended the capacitors — C1, C3, C6 and C9 — are featuring higher frequency efficiency to prevent the oscillation.

■ APPLICATION NOTE

1. Procedure for Supplying Power

Supply the power to first V^{+2} (Battery side) and then V^{+1} (Step-up Converter side).

2. Input Dynamic Voltage Range

The reference voltage is fixed at 0.6V. Therefore input dynamic voltage range is not proportion to the power supply voltage.

The input signal over dynamic range makes distortion. For prevent the distortion, adjust the maximum input signal level.

3. Charge Sequence

Pop noise may not be happened with mode switch operation once output voltage becomes reference voltage. The "Charge Sequence" may shorter the time for power up initialization.

Charge Sequence: To set mode switch from standby to active during power up initialization, activate rapid charge circuit for stabilizing the output voltage.

TYPICAL CHARACTERISTICS

Operating Current vs. Operating Voltage

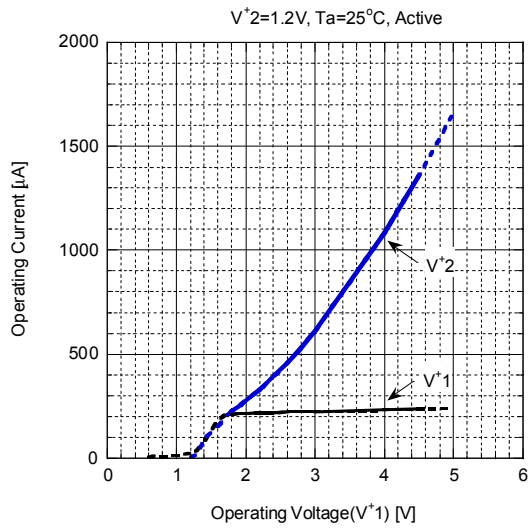

Operating Current vs. Operating Voltage

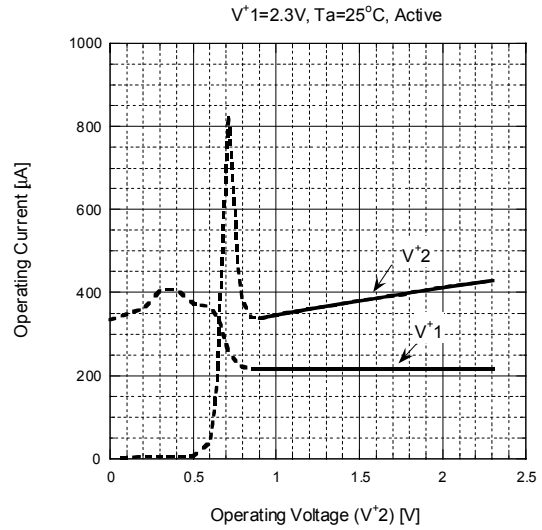

Operating Current vs. Operating Voltage

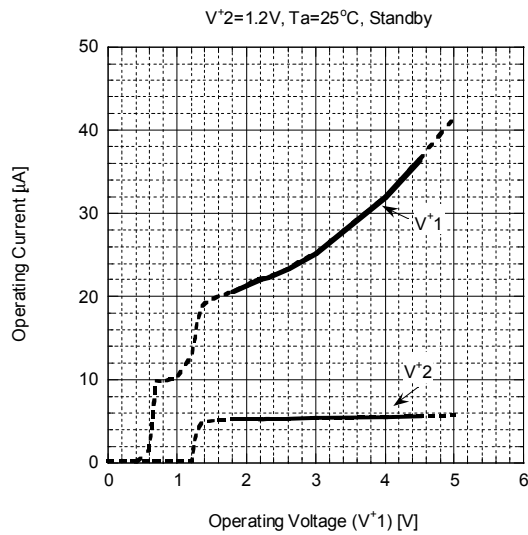

Operating Current vs. Operating Voltage

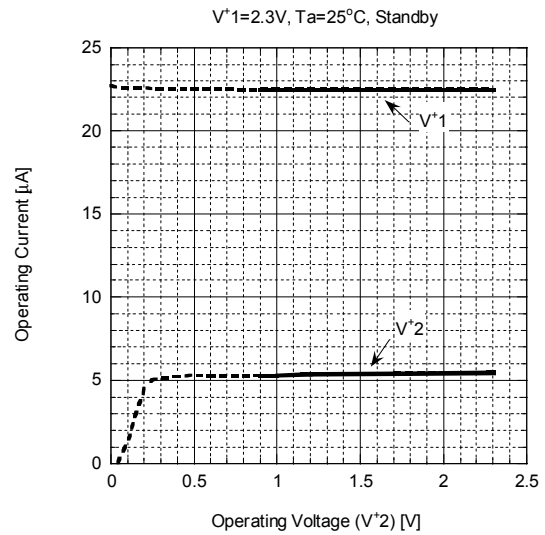

Operating Current vs. Temperature

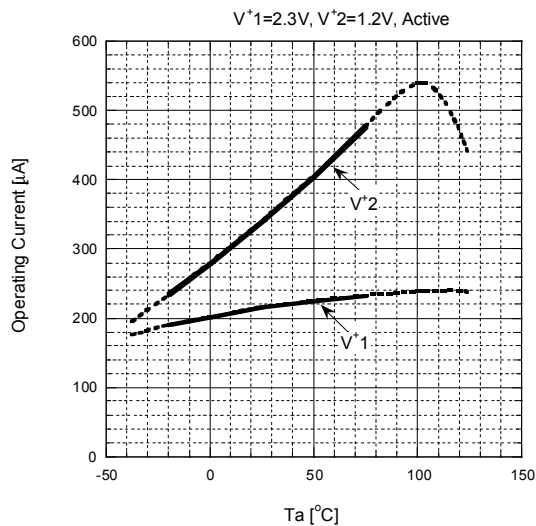

Operating Current vs. Temperature

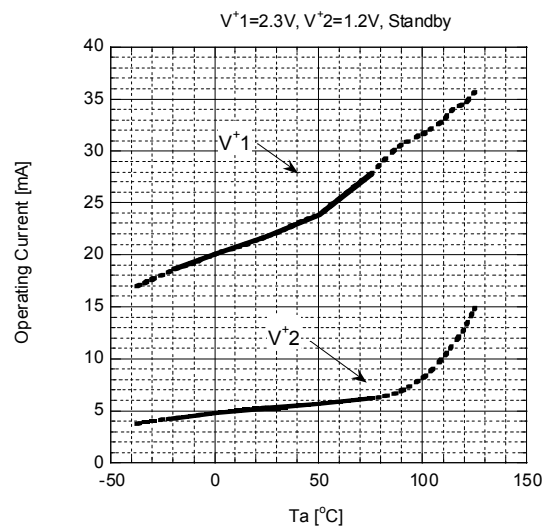

■ TYPICAL CHARACTERISTICS

Reference Voltage vs. Operating Voltage

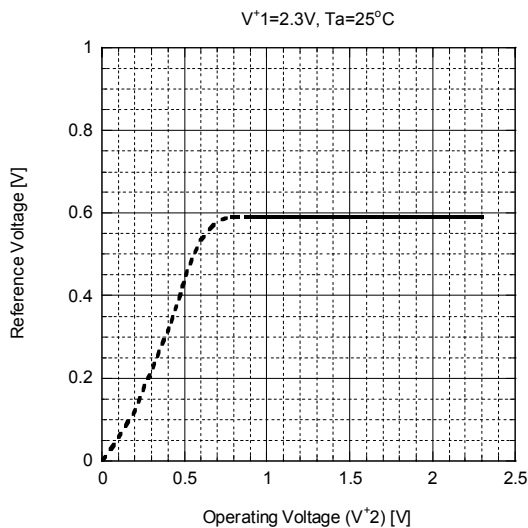

Reference Voltage vs. Temperature

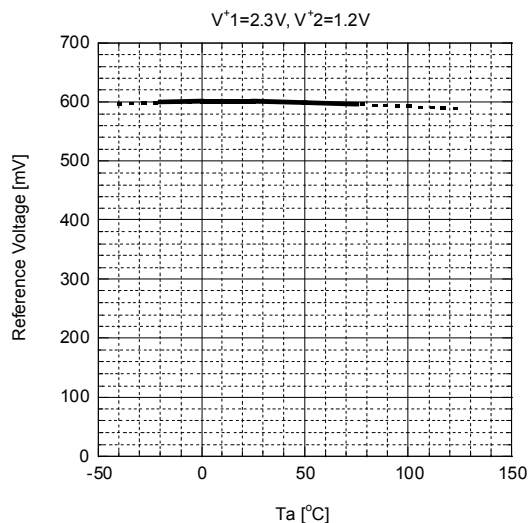

Total Harmonic Distortion vs. Output Power

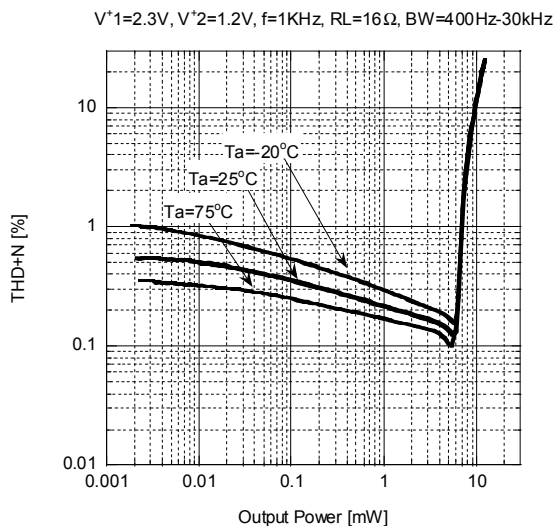

Total Harmonic Distortion vs. Output Power

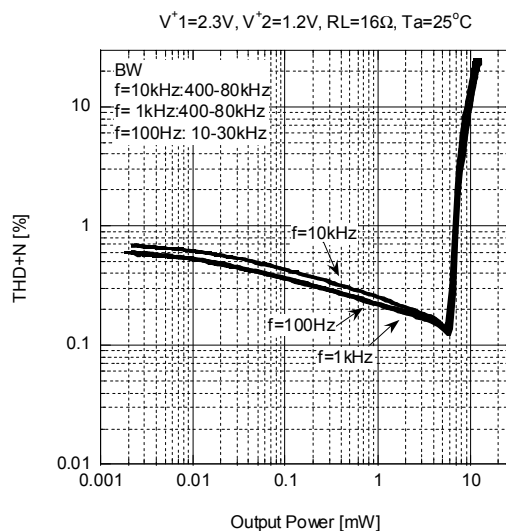

Output Power vs. Operating Voltage

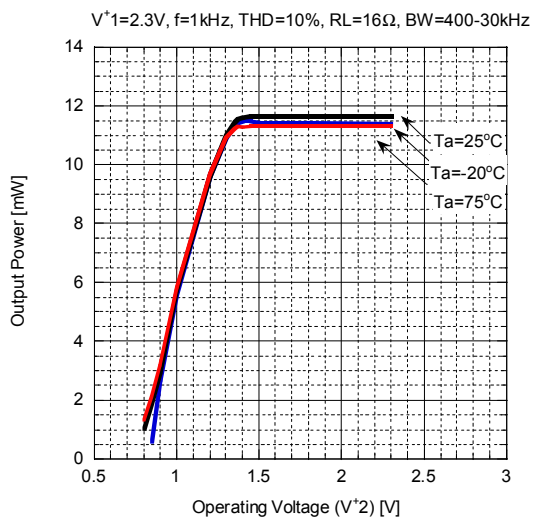

Power Dissipation vs. Output Power

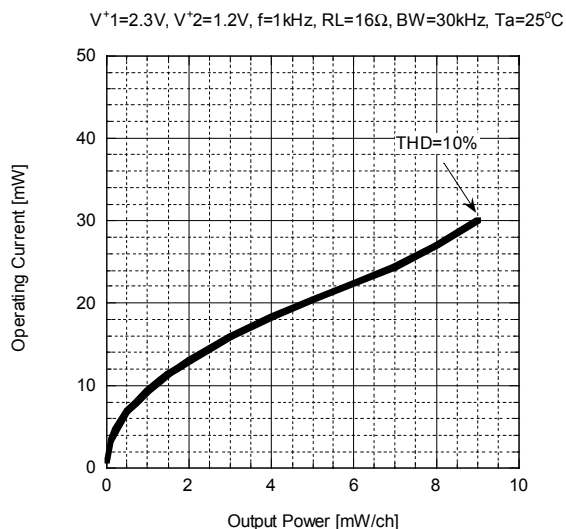

■ TYPICAL CHARACTERISTICS

Output Noise Voltage vs. Temperature

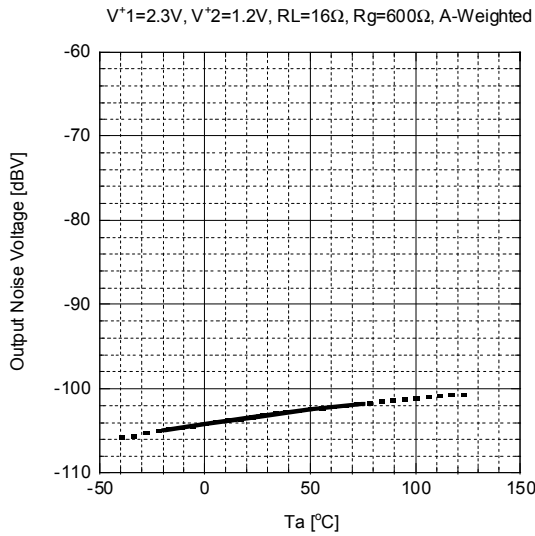

Channel Separation vs. Frequency

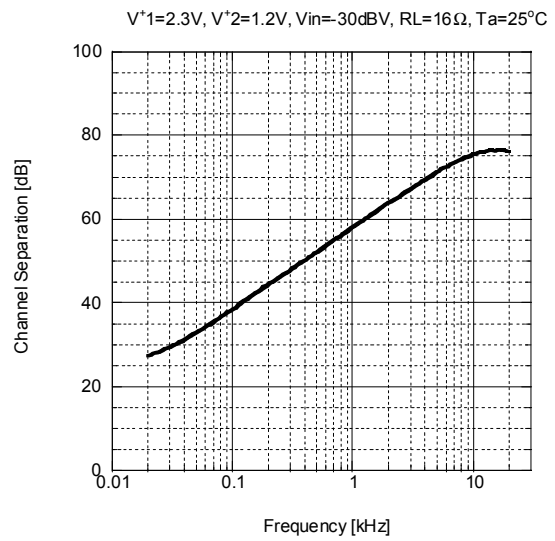

Mute Level vs. Frequency

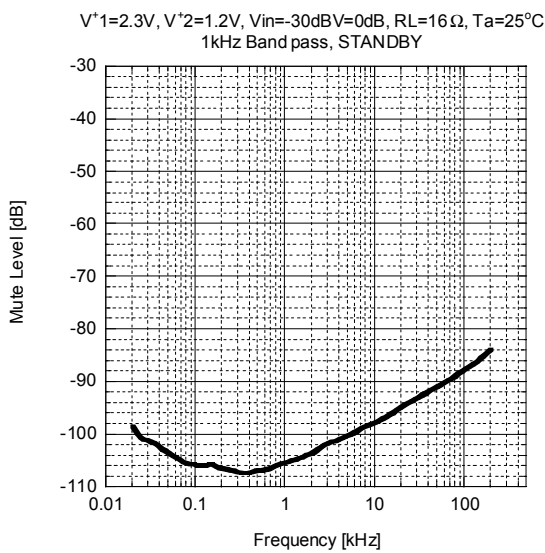

Mute Level vs. Temperature

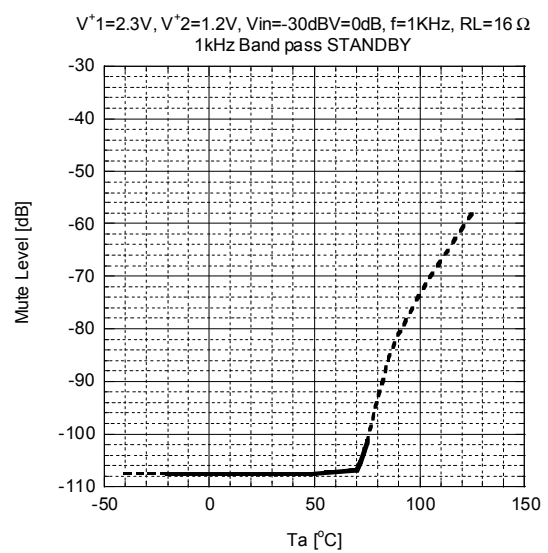

PSRR vs. frequency (V^+1)

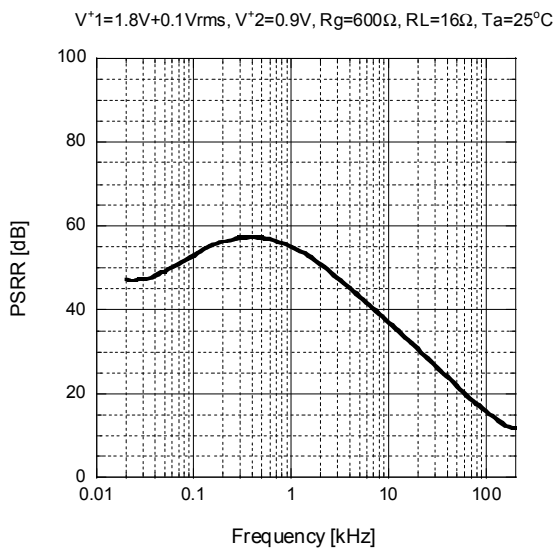

PSRR vs. frequency (V^+2)

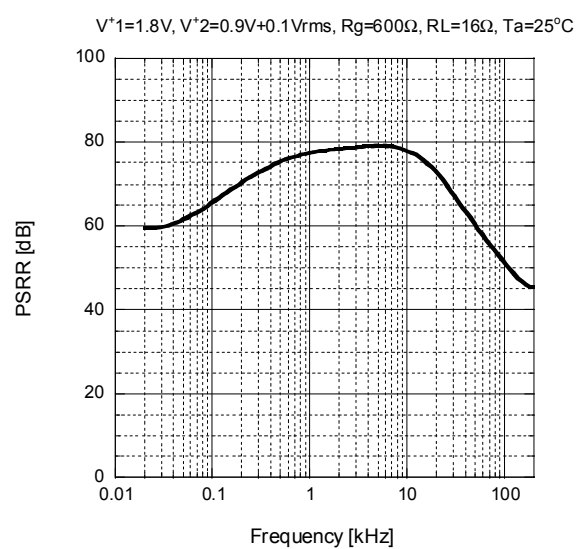

NJM2776

■ TYPICAL CHARACTERISTICS

Gain vs. STANDBY Control Voltage

$V^*1=2.3V$, $V^*2=1.2V$, $V_{in}=30dBV$, $f=1kHz$, $R_L=16\Omega$

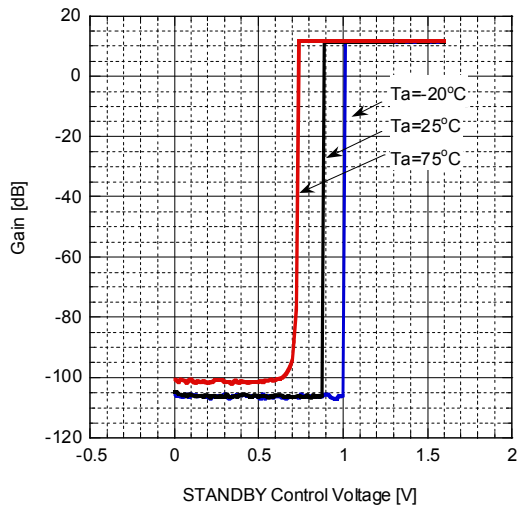

[CAUTION]

The specifications on this databook are only given for information, without any guarantee as regards either mistakes or omissions. The application circuits in this databook are described only to show representative usages of the product and not intended for the guarantee or permission of any right including the industrial rights.

Mouser Electronics

Authorized Distributor

Click to View Pricing, Inventory, Delivery & Lifecycle Information:

[NJR:](#)

[NJM2776RB2-TE2](#) [NJM2776RB2-TE1](#)



Компания «ЭлектроПласт» предлагает заключение долгосрочных отношений при поставках импортных электронных компонентов на взаимовыгодных условиях!

Наши преимущества:

- Оперативные поставки широкого спектра электронных компонентов отечественного и импортного производства напрямую от производителей и с крупнейших мировых складов;
- Поставка более 17-ти миллионов наименований электронных компонентов;
- Поставка сложных, дефицитных, либо снятых с производства позиций;
- Оперативные сроки поставки под заказ (от 5 рабочих дней);
- Экспресс доставка в любую точку России;
- Техническая поддержка проекта, помощь в подборе аналогов, поставка прототипов;
- Система менеджмента качества сертифицирована по Международному стандарту ISO 9001;
- Лицензия ФСБ на осуществление работ с использованием сведений, составляющих государственную тайну;
- Поставка специализированных компонентов (Xilinx, Altera, Analog Devices, Intersil, Interpoint, Microsemi, Aeroflex, Peregrine, Syfer, Eurofarad, Texas Instrument, Miteq, Cobham, E2V, MA-COM, Hittite, Mini-Circuits, General Dynamics и др.);

Помимо этого, одним из направлений компании «ЭлектроПласт» является направление «Источники питания». Мы предлагаем Вам помощь Конструкторского отдела:

- Подбор оптимального решения, техническое обоснование при выборе компонента;
- Подбор аналогов;
- Консультации по применению компонента;
- Поставка образцов и прототипов;
- Техническая поддержка проекта;
- Защита от снятия компонента с производства.



Как с нами связаться

Телефон: 8 (812) 309 58 32 (многоканальный)

Факс: 8 (812) 320-02-42

Электронная почта: org@eplast1.ru

Адрес: 198099, г. Санкт-Петербург, ул. Калинина, дом 2, корпус 4, литера А.