

## MAX40002–MAX40005 MAX40012–MAX40015

## nanoPower 4-Bump Comparator in Ultra-Tiny 0.73mm x 0.73mm WLP/SOT23 Packages

### General Description

The MAX40002–MAX40005 and MAX40012–MAX40015 tiny, single comparators are ideal for a wide variety of portable electronics applications such as cell phones, media players, and notebooks that have extremely tight board space and power constraints. These comparators are offered in both, a miniature 4-bump wafer-level package (WLP) with a 0.73mm x 0.73mm footprint (as small as two 0402 resistors) and a 5-pin SOT23 package.

This device family operates with a supply voltage range from 1.7V to 5.5V (either  $V_{CC}$  or external  $V_{REF}$ ), and consumes only 500nA of supply current. These devices have a wide input-voltage range of 0.1V to 5.5V, independent of the supply voltage, and maintain high impedance at the inputs even when powered down ( $V_{CC}$  or external  $V_{REF} = 0V$ ). They also feature internal filtering to provide high RF immunity.

The MAX40002–MAX40003 and MAX40012–MAX40013 have open-drain outputs, while the MAX40004–MAX40005 and MAX40014–MAX40015 feature push-pull outputs. The MAX40002/MAX40004 and MAX40012–MAX40014 have noninverting inputs, while the MAX40003/MAX40005 and MAX40013–MAX40015 have inverting inputs (see the [Selector Guide](#) for more information).

These devices also come with an internal reference. The reference voltage is preset at the factory and parts are offered with the following voltage options: 0.2V, 0.5V, 0.9V or 1.222V (see [Ordering Information](#) table).

These devices are fully specified over  $-40^{\circ}\text{C}$  to  $+125^{\circ}\text{C}$  automotive temperature range.

### Applications

- Mobile Devices
- Portable Medical Devices
- Portable Instrumentation
- Notebook Computers
- Electronic Toys

### Benefits and Features

- Tiny 0.73mm x 0.73mm, 4-Bump WLP and 5-Pin SOT23 Packages Save Board Space
- Ultra-Low 500nA Operating Current Preserves Battery Power in Applications Where Comparator is Constantly Monitoring
- 1.7V to 5.5V Supply Range Allows Operation from 1.8V, 2.5V, 3V and 5V Systems
- Input Voltage Range: 0.1V to 5.5V
- External REF Range: 1.7V to 5.5V
- Wide Variety of Factory-Trimmed Reference Voltages Saves Space and Cost of External Reference:
  - 0.2V, 0.5V, 0.9V, 1.222V
  - 9 $\mu\text{s}$  Propagation Delay
- $-40^{\circ}\text{C}$  to  $+125^{\circ}\text{C}$  Specified Temperature Range

[Ordering Information](#) appears at end of data sheet.

### Absolute Maximum Ratings

V <sub>CC</sub> /REF to GND	-0.3V to +6V
IN to GND	-0.3V to +6V
OUT (Open-Drain) to GND	-0.3V to +6V
OUT (Pushpull) to GND	-0.3V to V <sub>CC</sub> + 0.3V
Continuous Current Into Any Input/Output	±20mA
Continuous Power Dissipation (T <sub>A</sub> = +70°C)	
4-Bump WLP (Derate 9.58mW/°C above +70°C)	766.4mW
5-Pin SOT (Derate 3.9mW/°C above +70°C)	312.6mW

Operating Temperature Range	-40°C to +125°C
Junction Temperature	+150°C
Storage Temperature Range	-65°C to +150°C
Lead Temperature (soldering, 10s)	+300°C
Soldering Temperature (reflow)	260°C

### Package Thermal Characteristics (Note 1)

WLP  
Junction-to-Ambient Thermal Resistance (θ<sub>JA</sub>) ...104.41°C/W

SOT23  
Junction-to-Ambient Thermal Resistance (θ<sub>JA</sub>) .....255.9°C/W  
Junction-to-Ambient Thermal Resistance (θ<sub>JC</sub>) .....81°C/W

**Note 1:** Package thermal resistances were obtained using the method described in JEDEC specification JESD51-7, using a four-layer board. For detailed information on package thermal considerations, refer to [www.maximintegrated.com/thermal-tutorial](http://www.maximintegrated.com/thermal-tutorial).

Stresses beyond those listed under "Absolute Maximum Ratings" may cause permanent damage to the device. These are stress ratings only, and functional operation of the device at these or any other conditions beyond those indicated in the operational sections of the specifications is not implied. Exposure to absolute maximum rating conditions for extended periods may affect device reliability.

### Electrical Characteristics

V<sub>CC</sub>/REF = 3.3V, R<sub>PULLUP</sub> = 100kΩ to V<sub>PULLUP</sub> = 3.3V, R<sub>L</sub> = ∞, C<sub>L</sub> = 20pF, T<sub>A</sub> = T<sub>MIN</sub> to T<sub>MAX</sub>. Typical values are at T<sub>A</sub> = +25°C, unless otherwise noted. (Note 2)

PARAMETER	SYMBOL	CONDITIONS	MIN	TYP	MAX	UNITS
<b>POWER SUPPLY VOLTAGE</b>						
V <sub>CC</sub> /REF Supply Voltage Range	V <sub>CC</sub> /V <sub>REF</sub>		1.7		5.5	V
V <sub>CC</sub> /REF Supply Current	I <sub>CC</sub>	V <sub>IN</sub> > 0, V <sub>OUT</sub> = low, no output or reference load current, T <sub>A</sub> = -40°C to +85°C		0.5	1.1	μA
		V <sub>IN</sub> > 0, V <sub>OUT</sub> = low, no output or reference load current, T <sub>A</sub> = -40°C to +125°C			1.3	
Power-Up Time				0.5		ms
<b>COMPARATOR</b>						
Input Voltage Range	V <sub>IN</sub>	T <sub>A</sub> = +25°C	0.1		V <sub>CC</sub> + 0.1	V
		T <sub>A</sub> = -40°C to +125°C	0.1		V <sub>CC</sub>	
Input Offset Voltage (For External V <sub>REF</sub> only) (Note 3)	V <sub>OS</sub>	Over V <sub>IN</sub> range, T <sub>A</sub> = -40°C to +85°C		0.5	27	mV
		Over V <sub>IN</sub> range, T <sub>A</sub> = -40°C to +125°C			32	

### Electrical Characteristics (continued)

$V_{CC}/REF = 3.3V$ ,  $R_{PULLUP} = 100k\Omega$  to  $V_{PULLUP} = 3.3V$ ,  $R_L = \infty$ ,  $C_L = 20pF$ ,  $T_A = T_{MIN}$  to  $T_{MAX}$ . Typical values are at  $T_A = +25^\circ C$ , unless otherwise noted. (Note 2)

PARAMETER	SYMBOL	CONDITIONS	MIN	TYP	MAX	UNITS
Input Offset Drift (For External $V_{REF}$ Only) (Note 3)					320	$\mu V/^\circ C$
Input Hysteresis	$V_{HYS}$	(Note 4)		8		mV
Input Bias Current		Over $V_{IN}$ range, $T_A = -40^\circ C$ to $+85^\circ C$		20	30	nA
		Over $V_{IN}$ range, $T_A = -40^\circ C$ to $+125^\circ C$			90	
Input Leakage Current ( $V_{CC}/REF = 0$ ) (MAX40002 and MAX40003)		No supply voltage, $T_A = -40^\circ C$ to $+85^\circ C$		20	30	nA
		No supply voltage, $T_A = -40^\circ C$ to $+125^\circ C$			80	
Input Capacitance		Either input, over $V_{CM}$ range		0.4		pF
Power Supply Rejection Ratio	PSRR	DC, internal $V_{REF}$	40			dB
		DC, external $V_{REF}$	45			
Output Voltage Swing Low	$V_{OL}$	Sinking 2mA, measured relative with GND			0.4	V
Output Voltage Swing High	$V_{OH}$	Sourcing 1mA, measured with relative with $V_{CC}$			0.4	V
Output Leakage Current	$I_{O-LKG}$	Open-drain only, $V_{CC}/REF = 1.8V$ , $V_O = 5.5V$ , $T_A = -40^\circ C$ to $+125^\circ C$			100	nA
Propagation Delay (Note 5)	$t_{PD}$	100mV overdrive, push-pull OUT = low to high		25		$\mu s$
		100mV overdrive, open-drain, $R_{PU} = 100k\Omega$ , OUT = low to high		25		
		100mV overdrive, both push-pull and open-drain, OUT= high to low		9		
		20mV overdrive, push-pull OUT = low to high		50		
		20mV overdrive, open-drain, $R_{PU} = 100k\Omega$ , OUT = low to high		55		
		20mV overdrive, both push-pull and open-drain, OUT = high to low		45		
Rise Time	$t_R$	Push-pull output		800		ns
Fall Time	$t_F$			200		ns

### Electrical Characteristics (continued)

$V_{CC}/REF = 3.3V$ ,  $R_{PULLUP} = 100k\Omega$  to  $V_{PULLUP} = 3.3V$ ,  $R_L = \infty$ ,  $C_L = 20pF$ ,  $T_A = T_{MIN}$  to  $T_{MAX}$ . Typical values are at  $T_A = +25^\circ C$ , unless otherwise noted. (Note 2)

PARAMETER	SYMBOL	CONDITIONS	MIN	TYP	MAX	UNITS	
<b>INTERNAL REFERENCE VOLTAGE</b>							
Switching Threshold Voltage (Note 6)	$V_{REF-INT}$	$T_A = +25^\circ C$	MAX4000_ _ _ _ 02+	188	200	212	mV
		$T_A = -40^\circ C$ to $+85^\circ C$	MAX4000_ _ _ _ 02+	177		223	mV
		$T_A = -40^\circ C$ to $+125^\circ C$	MAX4000_ _ _ _ 02+	174		226	mV
		$T_A = +25^\circ C$	MAX4000_ _ _ _ 05+	485	500	515	mV
		$T_A = -40^\circ C$ to $+85^\circ C$	MAX4000_ _ _ _ 05+	468		532	mV
		$T_A = -40^\circ C$ to $+125^\circ C$	MAX4000_ _ _ _ 05+	463		537	mV
		$T_A = +25^\circ C$	MAX4001_ _ _ _ 09+	882	900	918	mV
		$T_A = -40^\circ C$ to $+85^\circ C$	MAX4001_ _ _ _ 09+	873		927	mV
		$T_A = -40^\circ C$ to $+125^\circ C$	MAX4001_ _ _ _ 09+ (WLP)	873		927	mV
			MAX4001_ _ _ _ 09+ (SOT23)	864		936	
		$T_A = +25^\circ C$	MAX4000_ _ _ _ 12+	1200	1222	1244	mV
		$T_A = -40^\circ C$ to $+85^\circ C$	MAX4000_ _ _ _ 12+	1169		1275	mV
$T_A = -40^\circ C$ to $+125^\circ C$	MAX4000_ _ _ _ 12+	1157		1287	mV		

**Note 2:** All devices are 100% production tested at  $T_A = +25^\circ C$ . Temperature limits are guaranteed by design.

**Note 3:**  $V_{OS}$  is the average of the positive and negative trip points minus  $V_{REF}$ .

**Note 4:** Hysteresis is the input voltage difference between the two switching points.

**Note 5:** Overdrive ( $V_{OD}$ ) is the voltage above or below the switching points. The input starts at 100mV below the trip point and use 50% input to 50% output for timing.  $V_{IN} = V_{REF\_INT} \pm V_{OD} \pm V_{HYS}$ .

**Note 6:** Switching Threshold Voltages include the offset voltage of the comparator and the internal reference.

### Typical Operating Characteristics

$V_{CC}/REF = 3.3V$ ,  $V_{GND} = 0V$ ,  $T_A = 25^\circ C$ , unless otherwise noted.

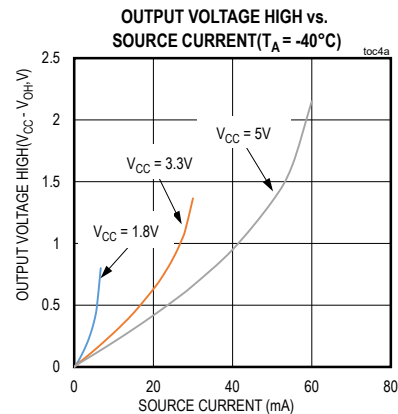
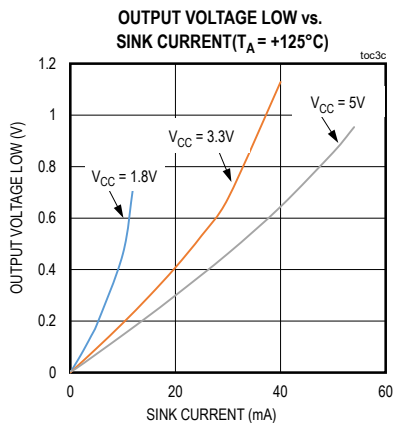
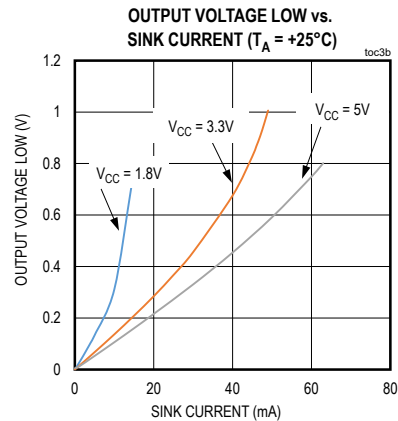
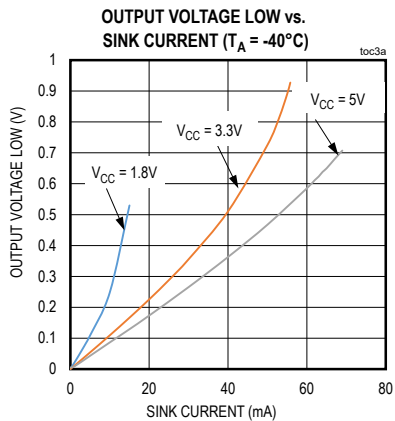
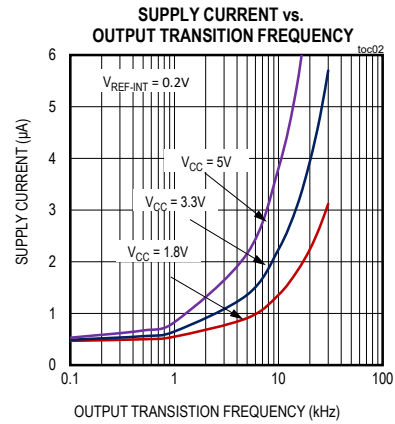
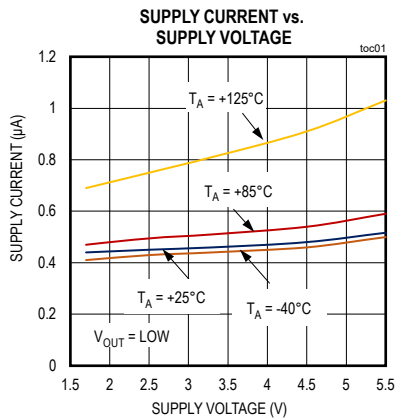

Typical Operating Characteristics (continued)

$V_{CC}/REF = 3.3V$ ,  $V_{GND} = 0V$ ,  $T_A = 25^\circ C$ , unless otherwise noted.

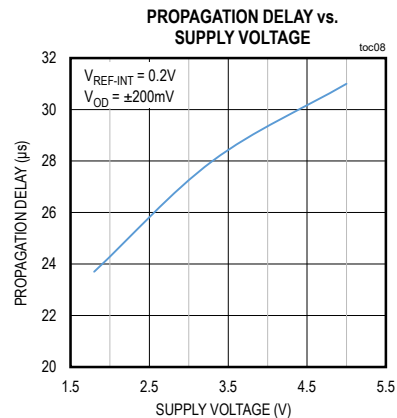
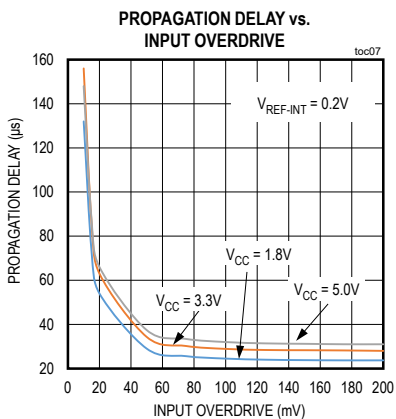
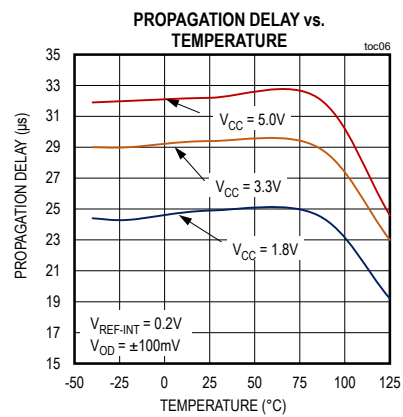
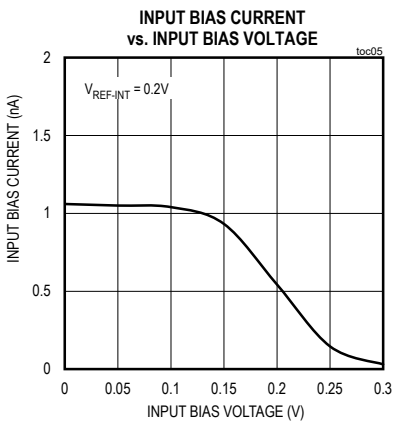
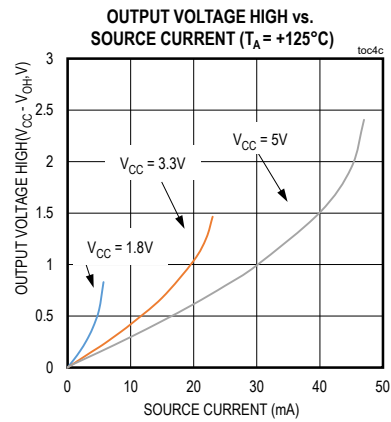
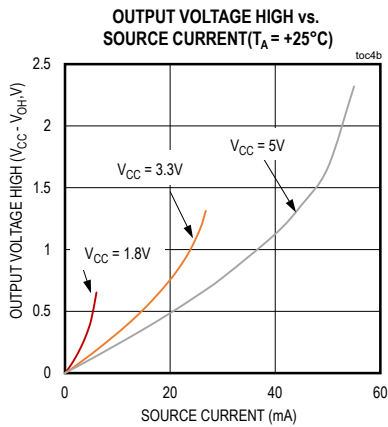

Typical Operating Characteristics (continued)

$V_{CC}/REF = 3.3V$ ,  $V_{GND} = 0V$ ,  $T_A = 25^\circ C$ , unless otherwise noted.

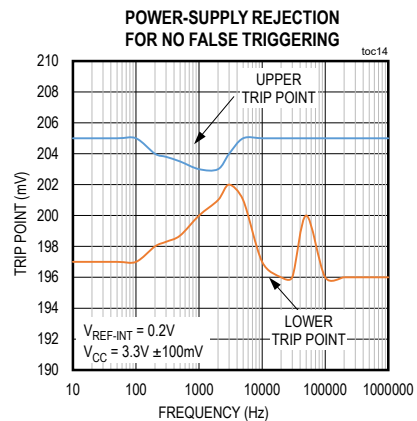
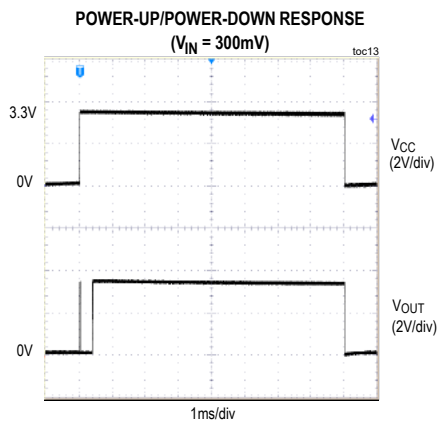
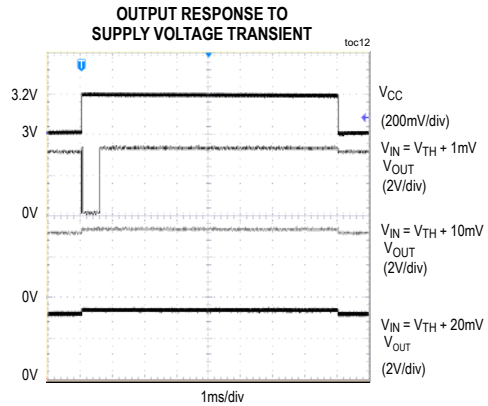
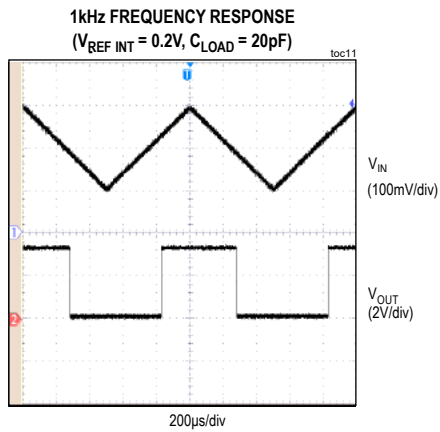
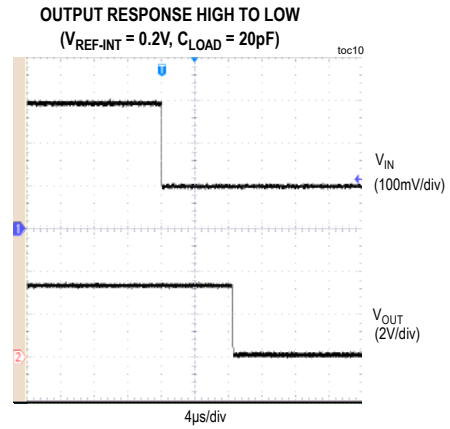
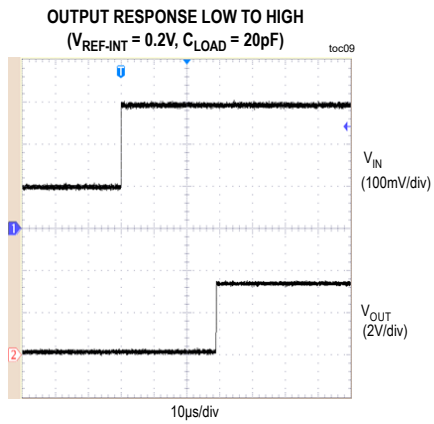

MAX40002–MAX40005  
MAX40012–MAX40015

nanoPower 4-Bump Comparator in Ultra-Tiny  
0.73mm x 0.73mm WLP/SOT23 Packages

## Pin Configurations

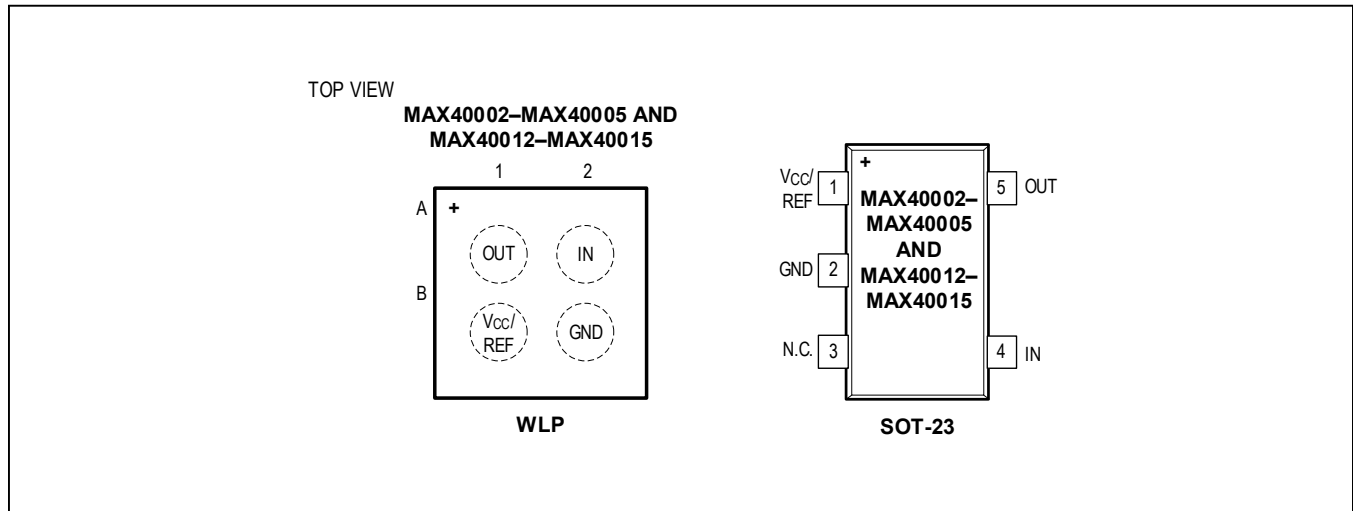

## Pin Description

PIN		NAME	FUNCTION
WLP	SOT23		
A1	5	OUT	Comparator Output. OUT is an Open-Drain Output (MAX40002/MAX40003 and MAX40012/MAX40013) or Push-Pull Output (MAX40004/MAX40005 and MAX40014/MAX40015). For the open-drain versions, connect a pullup resistor from OUT to any pullup voltage up to 5.5V for proper operation.
A2	4	IN	Comparator Input. The MAX40002/MAX40004 and MAX40012/MAX40014 have a noninverting input. The MAX40003/MAX40005 and MAX40013/MAX40015 have an inverting input (see <i>Input Stage Circuitry</i> for more information).
B1	1	V <sub>CC</sub> /REF	V <sub>CC</sub> Supply Voltage/External REF Voltage Input. V <sub>CC</sub> /REF is the supply voltage for devices with internal voltage reference (0.2V, 0.5V, 0.9V, 1.2V internal references). V <sub>CC</sub> /REF is the external reference input as well as the supply voltage for devices without the internal reference. Bypass V <sub>CC</sub> /REF with a 0.1μF capacitor to GND as close to the device pin as possible.
B2	2	GND	Ground.
—	3	N.C.	No Connect. Not internally connected.



## Detailed Description

The MAX40002–MAX40005 and MAX40012/MAX40015 are extremely small comparators ideal for compact, low-current and low-voltage applications.

The devices (with internal reference voltage) consume only 500nA (typ). Low-voltage operating capability makes the MAX40002–MAX40005 and MAX40012/MAX40015 extremely attractive to long-life, battery-operated applications. These applications can now use a single digital power supply rail used to power the new generation of microcontrollers. All parts are available in either tiny 4-bump WLP or 5-pin SOT23.

### Input-Stage Circuitry

Non-inverting inputs are available on the MAX40002/MAX40004 and MAX40012/MAX40014 and their associated outputs assert high when the input voltage is greater than the voltage reference. Inverting inputs are available on the MAX40003/MAX40005 and MAX40013/MAX40015 and their associated outputs assert low when the input voltage is greater than the voltage reference.

The MAX40002–MAX40005 and MAX40012/MAX40015 incorporate an innovative input-stage architecture that allows their input voltage to exceed  $V_{CC}$  by several volts (limited only by Absolute Maximum Ratings). This is unlike traditional comparators that have an input ESD diode clamp between the input and  $V_{CC}$ , limiting this maximum overvoltage to about 0.3V. The device architecture maintain a high input impedance to input signals even when the device power-supply voltage is completely turned off ( $V_{CC}$  or  $V_{REF}$  taken to 0V). This greatly benefits flexible power-saving schemes to be easily implemented in advanced battery-operated devices. On-chip filtering provides immunity from any RF noise being picked up by input traces. These devices feature an internal temperature-compensated, low-power voltage references for improved PSRR.

### Output Stage Structure

The MAX40002–MAX40003 and MAX40012/MAX40013 have open-drain output structures that allow them to interface to logic circuitry operating from supply voltages other than the one supplied to the part. These devices require an external pullup resistor or current-source for proper operation. Most microcontroller digital input ports can be readily programmed to include these pullup sources.

The MAX40004–MAX40005 and MAX40014/MAX40015 have a push-pull type output stage that can both sink and source current, eliminating the need for an external pullup resistor.

## Applications Information

### Bypassing $V_{CC}/REF$

Place a 0.1 $\mu$ F capacitor between  $V_{CC}/REF$  and GND as close to the device as possible. During a switching event, all comparators draw a current-spike from their power supply rails. This current-spike is minimized by the use of an internal Break-Before-Make design implementation.

### Hysteresis Operation

The MAX40002–MAX40005 and MAX40012/MAX40015 feature 8mV (typ) internal hysteresis for noise immunity and glitch-free operation. If additional hysteresis is needed, an external positive feedback network can be easily implemented on the MAX40002/MAX40004 and MAX40012/MAX40014 with noninverting input devices (both internal and external reference). Additional external hysteresis is not recommended for the MAX40003/MAX40005 and MAX40013/MAX40015 (with external reference) due to possible crossover current related noise problems. Additional external hysteresis is not possible on the MAX40003/MAX40005 and MAX40013/MAX40015 (internal reference) because the noninverting input of the comparator is not externally accessible.

### Adaptive Signal Level Detector

The MAX40002/MAX40012 and MAX40003/MAX40013 can be used as an adaptive signal-level detector. Feed a DAC output voltage to REF and connect the input to a variable signal level. As the DAC output voltage is varied from 1.7V to 5.5V, a corresponding signal level threshold detector circuit is implemented (Figure 1).

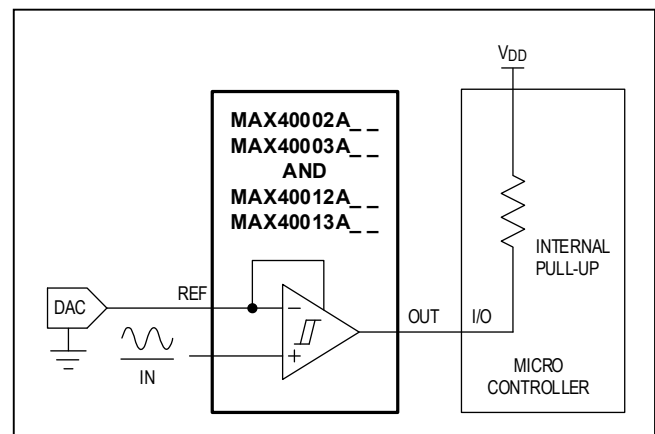
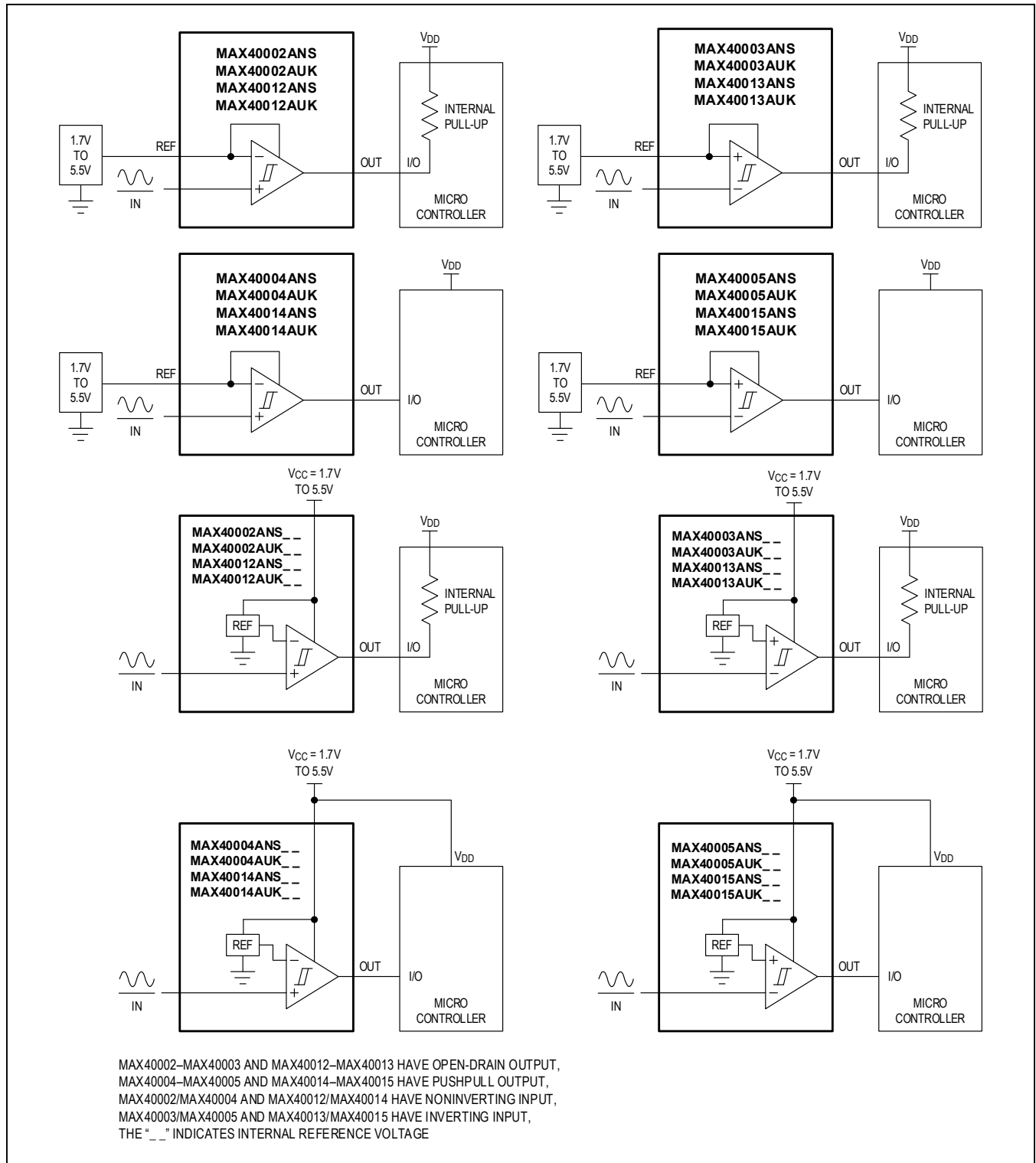

Figure 1. Adaptive Signal-Level Detector

**Table 1. How Devices Behave Under Various Input Voltage Conditions**

PART	V <sub>REF</sub>	INPUT POLARITY	INPUT VOLTAGE CONDITIONS	ACTION AT OUTPUT
MAX40002, MAX40004, MAX40012, MAX40014	External	Noninverting	$V_{IN} > V_{REF}$	Output goes high
			$V_{IN} < V_{REF}$	Output goes low
Inverting		$V_{IN} > V_{REF}$	Output goes low	
		$V_{IN} < V_{REF}$	Output goes high	
MAX40002, MAX40004, MAX40012, MAX40014	Internal	Noninverting	$V_{IN} > V_{REF\_INT}$	Output goes high
			$V_{IN} < V_{REF\_INT}$	Output goes low
Inverting		$V_{IN} > V_{REF\_INT}$	Output goes low	
		$V_{IN} < V_{REF\_INT}$	Output goes high	
MAX40003, MAX40005, MAX40013, MAX40015				

Typical Operating Circuits



MAX40002–MAX40005  
MAX40012–MAX40015

nanoPower 4-Bump Comparator in Ultra-Tiny  
0.73mm x 0.73mm WLP/SOT23 Packages

## Selector Guide

PART NUMBER	INTERNAL REFERENCE VOLTAGE (V)	INPUT	OUTPUT	TOP MARK
MAX40002ANS+T	—	Noninverting	OPEN-DRAIN	+I
MAX40002AUK+T*	—	Noninverting	OPEN-DRAIN	+AMHU
MAX40002ANS02+T	0.2	Noninverting	OPEN-DRAIN	+M
MAX40002AUK02+T	0.2	Noninverting	OPEN-DRAIN	+AMHV
MAX40002ANS05+T*	0.5	Noninverting	OPEN-DRAIN	+N
MAX40002AUK05+T*	0.5	Noninverting	OPEN-DRAIN	+AMHW
MAX40002ANS12+T	1.2	Noninverting	OPEN-DRAIN	+P
MAX40002AUK12+T*	1.2	Noninverting	OPEN-DRAIN	+AMHY
MAX40003ANS+T*	—	Inverting	OPEN-DRAIN	+J
MAX40003AUK+T*	—	Inverting	OPEN-DRAIN	+AMHZ
MAX40003ANS02+T	0.2	Inverting	OPEN-DRAIN	+Q
MAX40003AUK02+T*	0.2	Inverting	OPEN-DRAIN	+AMIA
MAX40003ANS05+T*	0.5	Inverting	OPEN-DRAIN	+R
MAX40003AUK05+T*	0.5	Inverting	OPEN-DRAIN	+AMIB
MAX40003ANS12+T	1.2	Inverting	OPEN-DRAIN	+T
MAX40003AUK12+T*	1.2	Inverting	OPEN-DRAIN	+AMID
MAX40004ANS+T*	—	Noninverting	PUSHPULL	+K
MAX40004AUK+T*	—	Noninverting	PUSHPULL	+AMIE
MAX40004ANS02+T	0.2	Noninverting	PUSHPULL	+W
MAX40004AUK02+T*	0.2	Noninverting	PUSHPULL	+AMIF
MAX40004ANS05+T*	0.5	Noninverting	PUSHPULL	+X
MAX40004AUK05+T*	0.5	Noninverting	PUSHPULL	+AMIG
MAX40004ANS12+T*	1.2	Noninverting	PUSHPULL	+U
MAX40004AUK12+T*	1.2	Noninverting	PUSHPULL	+AMIJ
MAX40005ANS+T	—	Inverting	PUSHPULL	+L
MAX40005AUK+T*	—	Inverting	PUSHPULL	+AMIK
MAX40005ANS02+T	0.2	Inverting	PUSHPULL	+Z
MAX40005AUK02+T*	0.2	Inverting	PUSHPULL	+AMIL
MAX40005ANS05+T	0.5	Inverting	PUSHPULL	+1
MAX40005AUK05+T*	0.5	Inverting	PUSHPULL	+AMIM
MAX40005ANS12+T*	1.2	Inverting	PUSHPULL	+V
MAX40005AUK12+T*	1.2	Inverting	PUSHPULL	+AMIO
MAX40012ANS09+T*	0.9V	Noninverting	OPEN-DRAIN	+4
MAX40012AUK09+T*	0.9V	Noninverting	OPEN-DRAIN	+AMIS
MAX40013ANS09+T*	0.9V	Inverting	OPEN-DRAIN	+5
MAX40013AUK09+T*	0.9V	Inverting	OPEN-DRAIN	+AMIT
MAX40014ANS09+T	0.9V	Noninverting	PUSHPULL	+6
MAX40014AUK09+T	0.9V	Noninverting	PUSHPULL	+AMIU
MAX40015ANS09+T*	0.9V	Inverting	PUSHPULL	+7
MAX40015AUK09+T*	0.9V	Inverting	PUSHPULL	+AMIV

\*Future product—contact factory for availability.

MAX40002–MAX40005  
MAX40012–MAX40015

nanoPower 4-Bump Comparator in Ultra-Tiny  
0.73mm x 0.73mm WLP/SOT23 Packages

## Ordering Information

PART	TEMP RANGE	PIN-PACKAGE
MAX40002ANS+T	-40°C to +125°C	4 WLP
MAX40002ANS__+T	-40°C to +125°C	4 WLP
MAX40002AUK+T*	-40°C to +125°C	5 SOT23
MAX40002AUK__+T	-40°C to +125°C	5 SOT23
MAX40003ANS+T*	-40°C to +125°C	4 WLP
MAX40003ANS__+T	-40°C to +125°C	4 WLP
MAX40003AUK+T*	-40°C to +125°C	5 SOT23
MAX40003AUK__+T*	-40°C to +125°C	5 SOT23
MAX40004ANS+T*	-40°C to +125°C	4 WLP
MAX40004ANS__+T	-40°C to +125°C	4 WLP
MAX40004AUK+T*	-40°C to +125°C	5 SOT23
MAX40004AUK__+T*	-40°C to +125°C	5 SOT23
MAX40005ANS+T	-40°C to +125°C	4 WLP
MAX40005ANS__+T	-40°C to +125°C	4 WLP
MAX40005AUK+T	-40°C to +125°C	5 SOT23
MAX40005AUK__+T*	-40°C to +125°C	5 SOT23
MAX40012ANS09+T*	-40°C to +125°C	4 WLP
MAX40013ANS09+T*	-40°C to +125°C	4 WLP
MAX40014ANS09+T	-40°C to +125°C	4 WLP
MAX40015ANS09+T*	-40°C to +125°C	4 WLP
MAX40012AUK09+T*	-40°C to +125°C	5 SOT23
MAX40013AUK09+T*	-40°C to +125°C	5 SOT23
MAX40014AUK09+T	-40°C to +125°C	5 SOT23
MAX40015AUK09+T*	-40°C to +125°C	5 SOT23

+Denotes a lead(Pb)-free/RoHS-compliant package.

T = Tape and reel.

\*Future product—contact factory for availability.

The “\_\_” are placeholders for internal reference voltage level.  
For example, the MAX40002ANS05+T has an onboard 0.5V reference voltage.

Devices without “\_\_” use external reference voltage as supply voltage.

## Chip Information

PROCESS: BiCMOS

MAX40002–MAX40005  
MAX40012–MAX40015

nanoPower 4-Bump Comparator in Ultra-Tiny  
0.73mm x 0.73mm WLP/SOT23 Packages

Package Information

For the latest package outline information and land patterns (footprints), go to [www.maximintegrated.com/packages](http://www.maximintegrated.com/packages). Note that a “+”, “#”, or “-” in the package code indicates RoHS status only. Package drawings may show a different suffix character, but the drawing pertains to the package regardless of RoHS status.

PACKAGE TYPE	PACKAGE CODE	OUTLINE NO.	LAND PATTERN NO.
4 WLP	N40C0+1	<a href="#">21-100103</a>	Refer to <a href="#">Application Note AN1891</a>
5 SOT23	U5+1	<a href="#">21-0057</a>	<a href="#">90-0174</a>

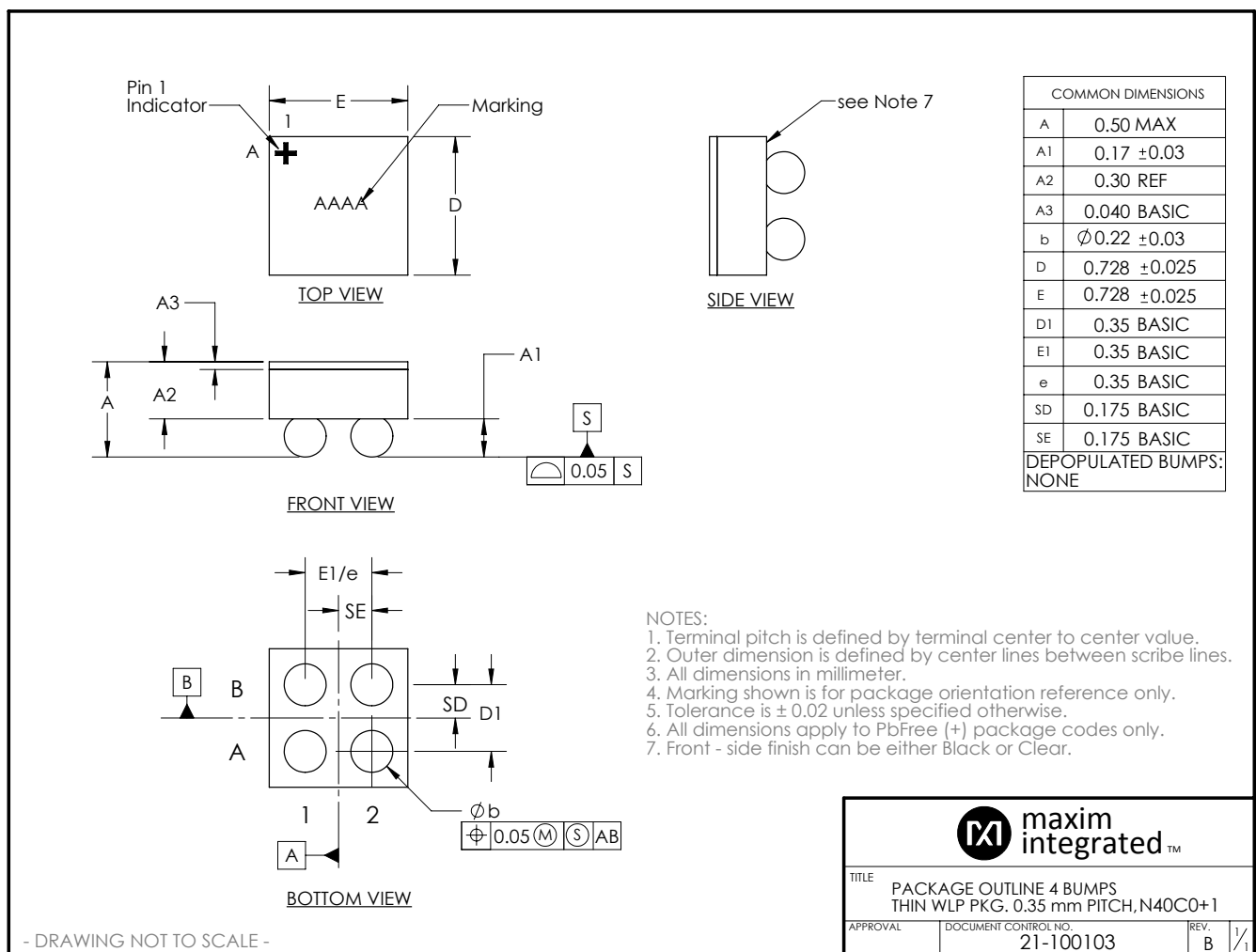

MAX40002–MAX40005  
 MAX40012–MAX40015

nanoPower 4-Bump Comparator in Ultra-Tiny  
 0.73mm x 0.73mm WLP/SOT23 Packages

### Package Information (continued)

For the latest package outline information and land patterns (footprints), go to [www.maximintegrated.com/packages](http://www.maximintegrated.com/packages). Note that a “+”, “#”, or “-” in the package code indicates RoHS status only. Package drawings may show a different suffix character, but the drawing pertains to the package regardless of RoHS status.

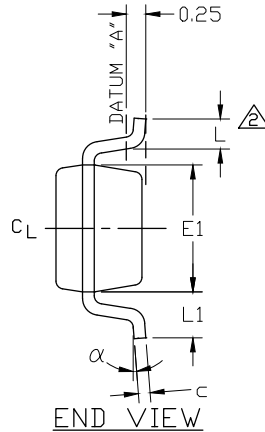
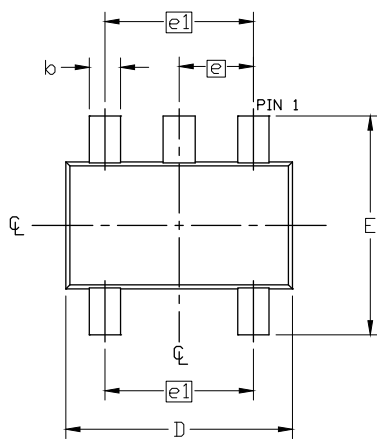

SYMBOL	MIN	NOM	MAX
A	0.90	1.25	1.45
A1	0.00	0.05	0.15
A2	0.90	1.10	1.30
b	0.35	0.40	0.50
c	0.08	0.15	0.20
D	2.80	2.90	3.00
E	2.60	2.80	3.00
E1	1.50	1.625	1.75
L	0.35	0.45	0.60
L1	0.60 REF		
e	0.95 BSC.		
e1	1.90 BSC.		
$\alpha$	0°	2.5°	8°

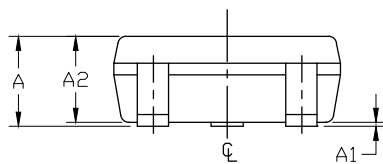

NOTES:

1. ALL DIMENSIONS ARE IN MILLIMETERS UNLESS OTHERWISE SPECIFIED.
2. FOOT LENGTH MEASURED AT INTERCEPT POINT BETWEEN DATUM A & LEAD SURFACE.
3. PACKAGE OUTLINE EXCLUSIVE OF MOLD FLASH & METAL BURR. MOLD FLASH, PROTRUSION OR METAL BURR SHOULD NOT EXCEED 0.25 MM.
4. MEETS JEDEC MO178, VARIATION AA.
5. LEADS TO BE COPLANAR WITHIN 0.10 mm.
6. SOLDER THICKNESS MEASURED AT FLAT SECTION OF LEAD BETWEEN 0.08mm AND 0.15mm FROM LEAD TIP.
7. MATERIAL MUST BE COMPLIANT WITH MAXIM SPECIFICATION 10-0131 FOR SUBSTANCE CONTENT, MUST BE EU ROHS COMPLIANT WITHOUT EXEMPTION AND PB-FREE.
8. ALL DIMENSIONS APPLY TO BOTH LEADED (-) AND LEAD FREE (+) PACKAGE CODES.
9. PKG CODES: U5-1, U5-1A, U5-2, U5-2A

—DRAWING NOT TO SCALE—



TITLE:  
 PACKAGE OUTLINE,  
 SL SOT23

APPROVAL	DOCUMENT CONTROL NO. 21-0057	REV. J	1/1
----------	---------------------------------	-----------	-----

MAX40002–MAX40005  
MAX40012–MAX40015

nanoPower 4-Bump Comparator in Ultra-Tiny  
0.73mm x 0.73mm WLP/SOT23 Packages

## Revision History

REVISION NUMBER	REVISION DATE	DESCRIPTION	PAGES CHANGED
0	3/17	Initial release	—
1	4/17	Updated <i>Selector Guide</i> and <i>Ordering Information</i> tables to remove future product status from MAX40002AUK02+T, MAX40005ANS+T, and MAX40005AUK+T	11, 12
2	8/17	Updated <i>Electrical Characteristics</i> table and <i>Selector Guide</i>	2–4, 11
3	9/17	Removed future product asterisk from MAX40002ANS+T in <i>Ordering Information</i> and <i>Selector Guide</i> tables	11, 12
4	11/17	Updated <i>Electrical Characteristics</i> table and <i>Selector Guide</i>	2–4, 11
5	12/18	Updated <i>Selector Guide</i> and removed package outline drawing	11, 13
6	11/19	Updated part numbers in data sheet title and throughout document	1–14
7	1/20	Updated <i>Electrical Characteristics</i> , <i>Selector Guide</i> , and <i>Ordering Information</i>	4, 12, 13
8	5/20	Updated <i>Electrical Characteristics</i> , <i>Selector Guide</i> , <i>Ordering Information</i> , and <i>Package Information</i>	4, 12–15

For pricing, delivery, and ordering information, please visit Maxim Integrated's online storefront at <https://www.maximintegrated.com/en/storefront/storefront.html>.

Maxim Integrated cannot assume responsibility for use of any circuitry other than circuitry entirely embodied in a Maxim Integrated product. No circuit patent licenses are implied. Maxim Integrated reserves the right to change the circuitry and specifications without notice at any time. The parametric values (min and max limits) shown in the *Electrical Characteristics* table are guaranteed. Other parametric values quoted in this data sheet are provided for guidance.





Компания «ЭлектроПласт» предлагает заключение долгосрочных отношений при поставках импортных электронных компонентов на взаимовыгодных условиях!

Наши преимущества:

- Оперативные поставки широкого спектра электронных компонентов отечественного и импортного производства напрямую от производителей и с крупнейших мировых складов;
- Поставка более 17-ти миллионов наименований электронных компонентов;
- Поставка сложных, дефицитных, либо снятых с производства позиций;
- Оперативные сроки поставки под заказ (от 5 рабочих дней);
- Экспресс доставка в любую точку России;
- Техническая поддержка проекта, помощь в подборе аналогов, поставка прототипов;
- Система менеджмента качества сертифицирована по Международному стандарту ISO 9001;
- Лицензия ФСБ на осуществление работ с использованием сведений, составляющих государственную тайну;
- Поставка специализированных компонентов (Xilinx, Altera, Analog Devices, Intersil, Interpoint, Microsemi, Aeroflex, Peregrine, Syfer, Eurofarad, Texas Instrument, Miteq, Cobham, E2V, MA-COM, Hittite, Mini-Circuits, General Dynamics и др.);

Помимо этого, одним из направлений компании «ЭлектроПласт» является направление «Источники питания». Мы предлагаем Вам помощь Конструкторского отдела:

- Подбор оптимального решения, техническое обоснование при выборе компонента;
- Подбор аналогов;
- Консультации по применению компонента;
- Поставка образцов и прототипов;
- Техническая поддержка проекта;
- Защита от снятия компонента с производства.



#### Как с нами связаться

**Телефон:** 8 (812) 309 58 32 (многоканальный)

**Факс:** 8 (812) 320-02-42

**Электронная почта:** [org@eplast1.ru](mailto:org@eplast1.ru)

**Адрес:** 198099, г. Санкт-Петербург, ул. Калинина, дом 2, корпус 4, литера А.