



**Low profile:**  
**15.7mm .618inch height**  
**1a/1c 16A power relay**

# LZ RELAYS (ALZ)



RoHS compliant

Protective construction: Flux-resistant type

### FEATURES

- 1. Low profile type with height of 15.7 mm .618 inch**  
 Slim, low profile type with dimensions of 28.8 (L) × 12.5 (W) × 15.7 (H) mm  
 1.134 (L) × .492 (W) × .618 (H) inch.
- 2. High insulation resistance**  
 Superior insulation characteristics have been achieved by maintaining an insulation distance between coil and contacts of at least 10 mm for both creepage distance and clearances. Furthermore, anti-surge voltage is 10 kV and higher. (Supports European reinforced insulation requirement.)
- 3. Superior heat resistance**  
 Can be used in ambient temperatures up to 85°C 185°F for the class B and 105°C 221°F for the class F.
- 4. Low operating power**  
 Power saved with a nominal operating power of only 400 mW.

- 5. Conforms to the various safety standards:**  
 UL/C-UL, VDE approved.
- 6. Superior heat resistance and tracking resistance**  
 EN60335-1 GWT compliant (Tested by VDE) type available

### TYPICAL APPLICATIONS

- 1. Household electrical appliances**  
 TV, CATV, Audio equipment, Microwave ovens, and Heaters, etc.
- 2. Office equipment**  
 Copy machines, Packaged air conditioners, and Vending machines
- 3. Industrial equipment**  
 Machine tools, Robots, and Temperature controllers

### ORDERING INFORMATION

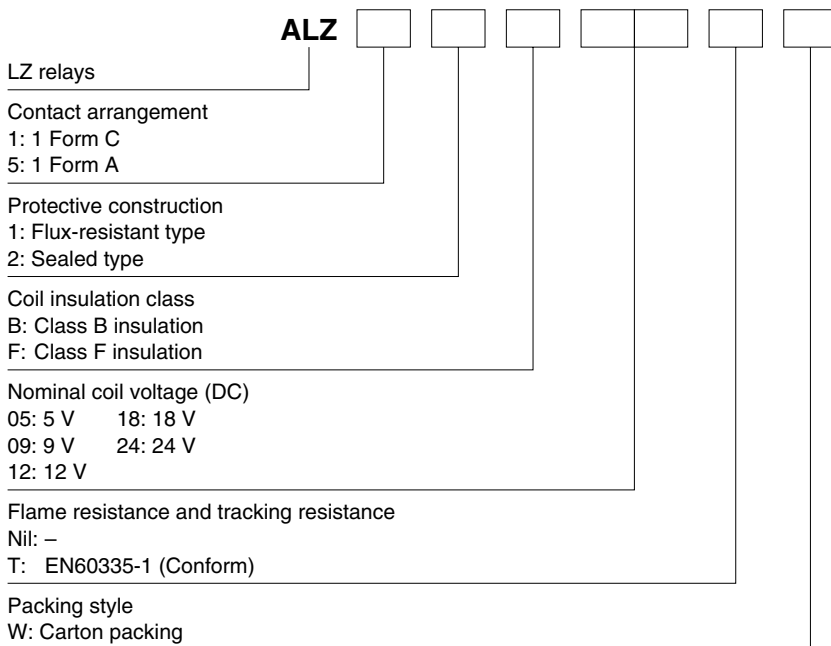

Notes: 1. Certified by UL/C-UL and VDE  
 2. Tube packing type is also available. Please consult us.

## TYPES

Contact arrangement	Coil voltage	Flux-resistant type		Sealed type	
		Class B insulation	Class F insulation	Class B insulation	Class F insulation
		Part No.	Part No.	Part No.	Part No.
1 Form C	5 V DC	ALZ11B05W	ALZ11F05W	ALZ12B05W	ALZ12F05W
	9 V DC	ALZ11B09W	ALZ11F09W	ALZ12B09W	ALZ12F09W
	12 V DC	ALZ11B12W	ALZ11F12W	ALZ12B12W	ALZ12F12W
	18 V DC	ALZ11B18W	ALZ11F18W	ALZ12B18W	ALZ12F18W
	24 V DC	ALZ11B24W	ALZ11F24W	ALZ12B24W	ALZ12F24W
1 Form A	5 V DC	ALZ51B05W	ALZ51F05W	ALZ52B05W	ALZ52F05W
	9 V DC	ALZ51B09W	ALZ51F09W	ALZ52B09W	ALZ52F09W
	12 V DC	ALZ51B12W	ALZ51F12W	ALZ52B12W	ALZ52F12W
	18 V DC	ALZ51B18W	ALZ51F18W	ALZ52B18W	ALZ52F18W
	24 V DC	ALZ51B24W	ALZ51F24W	ALZ52B24W	ALZ52F24W

Standard packing: Carton: 100 pcs.; Case: 500 pcs.

Notes: 1. Tube packing type is also available. Please consult us.

2. Carton packing symbol "W" is not marked on the relay.

3. EN60335-1 GWT compliant types available. When ordering, please add suffix "T".

Ex. ALZ51F12TW

## RATING

## 1. Coil data

Nominal coil voltage	Pick-up voltage (at 20°C 68°F)	Drop-out voltage (at 20°C 68°F)	Nominal operating current [ $\pm 10\%$ ] (at 20°C 68°F)	Coil resistance [ $\pm 10\%$ ] (at 20°C 68°F)	Nominal operating power (at 20°C 68°F)	Max. applied voltage (at 20°C 68°F)
5 V DC	Max. 70%V nominal voltage (Initial)	Min. 10%V nominal voltage (Initial)	80 mA	63 $\Omega$	400 mW	130%V of nominal voltage
9 V DC			44.4 mA	203 $\Omega$		
12 V DC			33.3 mA	360 $\Omega$		
18 V DC			22.2 mA	810 $\Omega$		
24 V DC			16.7 mA	1,440 $\Omega$		

## 2. Specifications

Characteristics	Item	Specifications	
Contact	Arrangement	1 Form C, 1 Form A	
	Contact resistance (Initial)	Max. 100 m $\Omega$ (By voltage drop 6V DC 1A)	
	Contact material	AgSnO <sub>2</sub> type	
Rating	Nominal switching capacity (resistive load)	16A 250V AC	
	Max. switching power (resistive load)	4,000V A	
	Max. switching voltage	440V AC	
	Max. switching current	16A	
	Nominal operating power	400mW	
	Min. switching capacity (reference value)*1	100mA 5V DC	
Electrical characteristics	Insulation resistance (Initial)	Min. 1,000 M $\Omega$ (at 500V DC) Measurement at same location as "Breakdown voltage" section.	
	Breakdown voltage (Initial)	Between open contacts	1,000 Vrms for 1 min. (Detection current: 10mA)
		Between contacts and coil	5,000 Vrms for 1 min. (Detection current: 10mA)
	Temperature rise (coil)	Max. 55°C 131°F [with nominal coil voltage and at 16A contact carrying current (resistance method) at 20°C 68°F]	
	Surge breakdown voltage*2 (Between contacts and coil) (Initial)	10,000 V	
	Operate time (at nominal voltage) (at 20°C 68°F)	Max. 15ms (excluding contact bounce time)	
Release time (at nominal voltage) (at 20°C 68°F)	Max. 5ms (excluding contact bounce time, without diode)		
Mechanical characteristics	Shock resistance	Functional	100 m/s <sup>2</sup> (Half-wave pulse of sine wave: 11ms; detection time: 10 $\mu$ s)
		Destructive	1,000 m/s <sup>2</sup> (Half-wave pulse of sine wave: 6ms)
	Vibration resistance	Functional	10 to 55Hz at double amplitude of 1.5mm (Detection time: 10 $\mu$ s) (Only the N.C. side of 1 Form C is 0.8mm)
		Destructive	10 to 55Hz at double amplitude of 1.5mm
Expected life	Mechanical (at 180 times/min.)	Min. 10 <sup>7</sup>	
	Electrical (at 20 times/min.)*3	N.O.: Min. 10 <sup>5</sup> , N.C.: Min. 5 $\times$ 10 <sup>4</sup>	
Conditions	Conditions for operation, transport and storage*4, *5	Ambient temperature: -40°C to +85°C -40°F to +185°F (Class B), Humidity: 5 to 85% R.H. (Not freezing and condensing at low temperature)	
	Max. operating speed	20 times/min. (at nominal switching capacity)	
Unit weight		Approx. 12 g .42 oz	

Notes: \*1. This value can change due to the switching frequency, environmental conditions, and desired reliability level, therefore it is recommended to check this with the actual load.

\*2. Wave is standard shock voltage of  $\pm 1.2 \times 50\mu$ s according to JEC-212-1981.

\*3. In order to obtain the full rated life cycles, the relay should be properly vented by removing the vent nib. More detail, please look at caution for NOTES.

\*4. Class F type is ambient temperature 105°C 221°F.

\*5. The upper limit of the ambient temperature is the maximum temperature that can satisfy the coil temperature rise value. Refer to Usage, transport and storage conditions in NOTES.

\*Please note that some of the specifications listed above may not comply with overseas standards.

## REFERENCE DATA

1. Max. switching power (AC resistive load)

2. Max. switching power (DC resistive load)

3. Coil temperature rise

Sample: ALZ11F12, 5pcs.  
Measured portion: coil inside  
Contact current: 0 A, 16 A

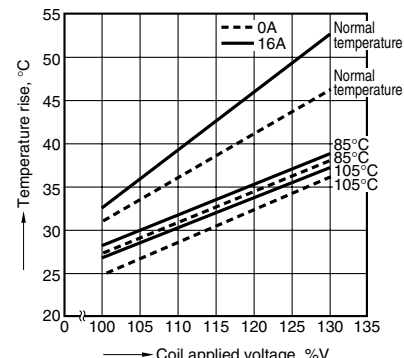
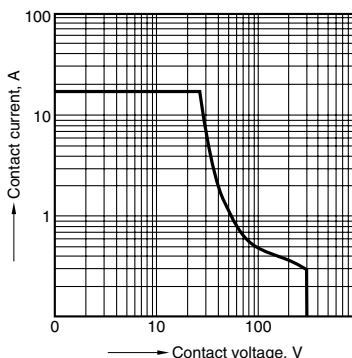
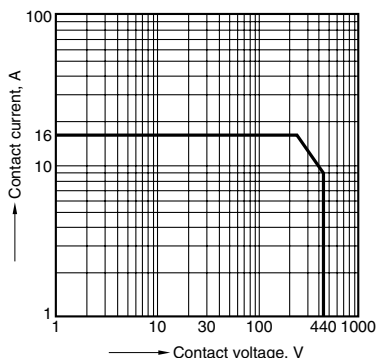

## DIMENSIONS (mm inch)

The CAD data of the products with a **CAD Data** mark can be downloaded from: <http://industrial.panasonic.com/ac/e/>

### 1. 1 Form A type

**CAD Data**



#### External dimensions

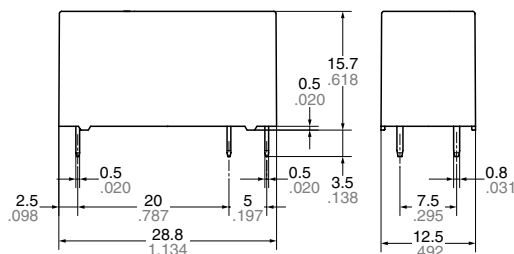

#### PC board pattern

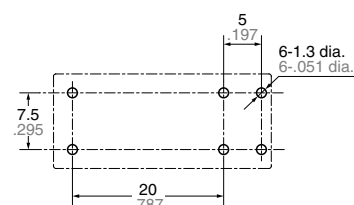

Tolerance:  $\pm 0.1 \pm 0.004$

#### Schematic (Bottom view)

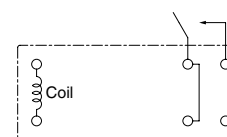

<b>Dimension:</b>	<b>Tolerance</b>
Less than 1mm .039inch:	$\pm 0.1 \pm 0.004$
Min. 1mm .039inch less than 3mm .118 inch:	$\pm 0.2 \pm 0.008$
Min. 3mm .118 inch:	$\pm 0.3 \pm 0.012$

### 2. 1 Form C type

**CAD Data**



#### External dimensions

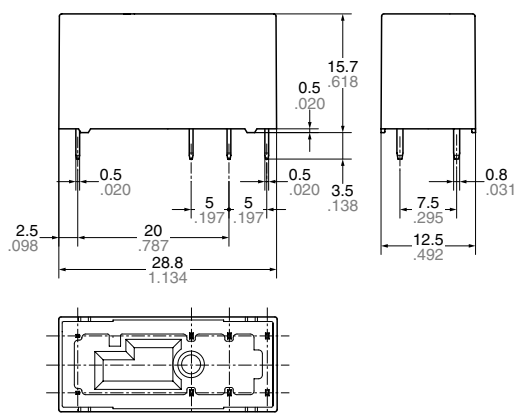

#### PC board pattern

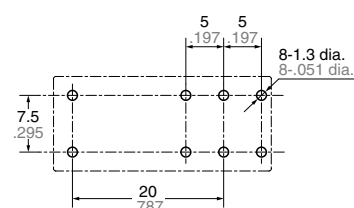

Tolerance:  $\pm 0.1 \pm 0.004$

#### Schematic (Bottom view)

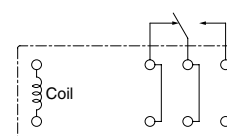

<b>Dimension:</b>	<b>Tolerance</b>
Less than 1mm .039inch:	$\pm 0.1 \pm 0.004$
Min. 1mm .039inch less than 3mm .118 inch:	$\pm 0.2 \pm 0.008$
Min. 3mm .118 inch:	$\pm 0.3 \pm 0.012$

## SAFETY STANDARDS

UL/C-UL (Recognized)		VDE (Certified)		TV rating (UL/CSA)	
File No.	Contact rating	File No.	Contact rating	File No.	Rating
E43149	16A 277V AC, 34.8LRA/7.2FLA/120V AC, 15LRA/3FLA/120V AC 10LRA/3FLA 240V AC, 20A 240V AC (N.O. only) 16A 30V DC, 25A 240V AC, 15A 240V AC Resistive load 105°C 221°F (N.O. only)	40000380	16A 250V AC (cos $\phi$ =1.0)	C-UL E43149	TV-5

\* CSA standard: Certified by C-UL

## NOTES

1. For cautions for use, please read

“GENERAL APPLICATION

GUIDELINES” on page B-1.

2. Electrical life (Sealed type)

In order to obtain the full rated life cycles, the relay should be properly vented by removing the vent nib after the soldering/ washing process.



# Mouser Electronics

Authorized Distributor

Click to View Pricing, Inventory, Delivery & Lifecycle Information:

## Panasonic:

[ALZ12F48](#) [ALZ11B05](#) [ALZ11B05W](#) [ALZ11B06](#) [ALZ11B06W](#) [ALZ11B09](#) [ALZ11B09W](#) [ALZ11B12](#) [ALZ11B12W](#)  
[ALZ11B18](#) [ALZ11B18W](#) [ALZ11B24](#) [ALZ11B24W](#) [ALZ11B48](#) [ALZ11B48W](#) [ALZ11B4H](#) [ALZ11B4HW](#) [ALZ11F05](#)  
[ALZ11F05W](#) [ALZ11F06](#) [ALZ11F06W](#) [ALZ11F09](#) [ALZ11F09W](#) [ALZ11F12](#) [ALZ11F12W](#) [ALZ11F18](#) [ALZ11F18W](#)  
[ALZ11F24](#) [ALZ11F24W](#) [ALZ11F48](#) [ALZ11F48W](#) [ALZ11F4H](#) [ALZ11F4HW](#) [ALZ12B05](#) [ALZ12B05W](#) [ALZ12B06](#)  
[ALZ12B06W](#) [ALZ12B09](#) [ALZ12B09W](#) [ALZ12B12W](#) [ALZ12B18](#) [ALZ12B18W](#) [ALZ12B24W](#) [ALZ12B48](#) [ALZ12B48W](#)  
[ALZ12B4H](#) [ALZ12B4HW](#) [ALZ12F05](#) [ALZ12F05W](#) [ALZ12F06](#) [ALZ12F06W](#) [ALZ12F09](#) [ALZ12F09W](#) [ALZ12F12W](#)  
[ALZ12F18](#) [ALZ12F18W](#) [ALZ12F22](#) [ALZ12F22W](#) [ALZ12F24W](#) [ALZ12F48W](#) [ALZ12F4H](#) [ALZ12F4HW](#) [ALZ22B05](#)  
[ALZ22B05W](#) [ALZ22B06](#) [ALZ22B06W](#) [ALZ22B09](#) [ALZ22B09W](#) [ALZ22B12W](#) [ALZ22B18](#) [ALZ22B18W](#) [ALZ22B24W](#)  
[ALZ22B48](#) [ALZ22B48W](#) [ALZ22B4H](#) [ALZ22B4HW](#) [ALZ22F05](#) [ALZ22F05W](#) [ALZ22F06](#) [ALZ22F06W](#) [ALZ22F09](#)  
[ALZ22F09W](#) [ALZ22F12W](#) [ALZ22F18](#) [ALZ22F18W](#) [ALZ22F24W](#) [ALZ22F48](#) [ALZ22F48W](#) [ALZ22F4H](#) [ALZ22F4HW](#)  
[ALZ51B05W](#) [ALZ51B09W](#) [ALZ51B12W](#) [ALZ51B18W](#) [ALZ51B24W](#) [ALZ51B48W](#) [ALZ51F05W](#) [ALZ51F09W](#)  
[ALZ51F12W](#) [ALZ51F18W](#)



Компания «ЭлектроПласт» предлагает заключение долгосрочных отношений при поставках импортных электронных компонентов на взаимовыгодных условиях!

Наши преимущества:

- Оперативные поставки широкого спектра электронных компонентов отечественного и импортного производства напрямую от производителей и с крупнейших мировых складов;
- Поставка более 17-ти миллионов наименований электронных компонентов;
- Поставка сложных, дефицитных, либо снятых с производства позиций;
- Оперативные сроки поставки под заказ (от 5 рабочих дней);
- Экспресс доставка в любую точку России;
- Техническая поддержка проекта, помощь в подборе аналогов, поставка прототипов;
- Система менеджмента качества сертифицирована по Международному стандарту ISO 9001;
- Лицензия ФСБ на осуществление работ с использованием сведений, составляющих государственную тайну;
- Поставка специализированных компонентов (Xilinx, Altera, Analog Devices, Intersil, Interpoint, Microsemi, Aeroflex, Peregrine, Syfer, Eurofarad, Texas Instrument, Miteq, Cobham, E2V, MA-COM, Hittite, Mini-Circuits, General Dynamics и др.);

Помимо этого, одним из направлений компании «ЭлектроПласт» является направление «Источники питания». Мы предлагаем Вам помощь Конструкторского отдела:

- Подбор оптимального решения, техническое обоснование при выборе компонента;
- Подбор аналогов;
- Консультации по применению компонента;
- Поставка образцов и прототипов;
- Техническая поддержка проекта;
- Защита от снятия компонента с производства.



#### Как с нами связаться

**Телефон:** 8 (812) 309 58 32 (многоканальный)

**Факс:** 8 (812) 320-02-42

**Электронная почта:** [org@eplast1.ru](mailto:org@eplast1.ru)

**Адрес:** 198099, г. Санкт-Петербург, ул. Калинина, дом 2, корпус 4, литера А.