

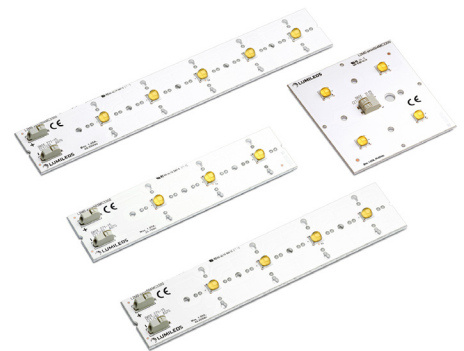

LUXEON XR-M

Bright, uniform light source in practical, convenient and easy to configure modules

LUXEON XR-M products are LED modules optimized for lighting applications requiring high power LED arrays mounted on a rigid and thermally conductive substrate. These versatile building blocks come with 3, 4 or 5 LUXEON M LEDs on a MCPCB substrate and are designed for ease of system integration, faster time to market, and use with industry standard optics. The 4 LED square version will become a complete IP66 solution when used in combination with standard third party optics and heat sink.



FEATURES AND BENEFITS

Typical 3200–5300 lumen building blocks with 140 lm/W efficacy @700mA, $T_c=85^\circ\text{C}$

Available in 70CRI 4000K, 5000K and 5700K

May be used with off-the-shelf individual lenses and lens plates for easy system integration

Constant board-to-board LED pitch for versatile system design

3, 4 and 5 LED linear board options and 4 LED square board option for design flexibility and luminaire adaptability

MCPCB for efficient heat dissipation and mechanical robustness

5 year limited warranty

PRIMARY APPLICATIONS

Architectural

High Bay & Low Bay

Outdoor

– Streetlights

– Stadium

Table of Contents

General Product Information	2
Product Test Conditions	2
Part Number Nomenclature	2
Lumen Maintenance	2
Environmental Compliance	2
Performance Characteristics	3
Product Selection Guide	3
Electrical and Thermal Characteristics	3
Absolute Maximum Ratings	4
Characteristic Curves	4
Spectral Power Distribution Characteristics	4
Radiation Pattern Characteristics	5
Color Bin Definition	5
Mechanical Dimensions	6
Packaging Information	10
Tray Dimensions	10
Product Packaging Considerations — Chemical Compatibility	12

General Product Information

Product Test Conditions

LUXEON XR-M products are specified using a forward DC drive current of 700mA and a board temperature, T_c of 85°C. The LEDs are electrically configured in series which means each LED is driven at equal current.

The LUXEON M LEDs on LUXEON XR-M are tested and binned using a DC drive current at 700mA and junction temperature, T_j of 85°C. The minimum, typical, and maximum performance numbers for LUXEON XR-M in this datasheet are derived from individual LED measurements. The confidence level on all minimum and maximum performance parameters in this datasheet is 99% to within individual LED tolerance.

Part Number Nomenclature

Part numbers for LUXEON XR-M follow the convention below:

L 2 M 0 – **A A B B** 0 0 **D** M C **E E** 0 0

Where:

- A A** – designates nominal ANSI CCT (40=4000K, 50=5000K, 57=5700K)
- B B** – designates minimum CRI (70=70CRI)
- D** – designates number of LEDs (3, 4 or 5)
- E E** – designates LED configuration (22=square, 33=linear)

Therefore, a LUXEON XR-M, 4000K, 70CRI, with 4 LEDs in a linear configuration will have the following part number:

L 2 M 0 – **4 0 7 0** 0 0 **4** M C **3 3** 0 0

For LUXEON XR-M CCT and CRI combinations not listed in this datasheet, contact your local Lumileds Sales Representative or Technical Solutions Manager.

Lumen Maintenance

Please contact your local Sales Representative or Lumileds Technical Solutions Manager for more information about the long-term performance of this product.

Environmental Compliance

Lumileds LLC is committed to providing environmentally friendly products to the solid-state lighting market. LUXEON XR-M is compliant to the European Union directives on the restriction of hazardous substances in electronic equipment, namely the RoHS Directive 2011/65/EU and REACH Regulation (EC) 1907/2006. Lumileds LLC will not intentionally add the following restricted materials to its products: lead, mercury, cadmium, hexavalent chromium, polybrominated biphenyls (PBB) or polybrominated diphenyl ethers (PBDE).

Performance Characteristics

Product Selection Guide

Table 1. Product performance of LUXEON XR-M at 700mA, $T_c=85^\circ\text{C}$.

CONFIGURATION	NOMINAL CCT	MINIMUM CRI ⁽¹⁾	LUMINOUS FLUX ⁽²⁾ (lm)		TYPICAL LUMINOUS EFFICACY (lm/W)	PART NUMBER
			MINIMUM	TYPICAL		
Square	4000K	70	4053	4211	138	L2M0-4070004MC2200
	5000K	70	4200	4363	144	L2M0-5070004MC2200
	5700K	70	4156	4318	142	L2M0-5770004MC2200
Linear	4000K	70	3040	3158	138	L2M0-4070003MC3300
	5000K	70	3150	3272	144	L2M0-5070003MC3300
	5700K	70	3117	3239	142	L2M0-5770003MC3300
	4000K	70	4053	4211	138	L2M0-4070004MC3300
	5000K	70	4200	4363	144	L2M0-5070004MC3300
	5700K	70	4156	4318	142	L2M0-5770004MC3300
	4000K	70	5067	5264	138	L2M0-4070005MC3300
	5000K	70	5249	5454	144	L2M0-5070005MC3300
	5700K	70	5195	5397	142	L2M0-5770005MC3300

Notes for Table 1:

1. Lumileds maintains a tolerance of ± 2 on CRI measurements.
2. Lumileds maintains a tolerance of $\pm 7.5\%$ on luminous flux measurements.

Electrical and Thermal Characteristics

Table 2. Electrical and thermal characteristics for LUXEON XR-M at 700mA, $T_c=85^\circ\text{C}$.

PART NUMBER	FORWARD VOLTAGE (V) ⁽¹⁾			TYPICAL THERMAL RESISTANCE — JUNCTION TO HEAT SINK (K/W) $R_{\text{THJ-HS}}$
	MINIMUM	TYPICAL	MAXIMUM	
L2M0-xxxx003MC3300	32.60	32.85	33.10	1.60
L2M0-xxxx004MCzz00	43.55	43.80	44.05	1.20
L2M0-xxxx005MC3300	54.50	54.75	55.00	0.96

Notes for Table 2:

1. Lumileds maintains a tolerance of $\pm 0.1\text{V}$ on forward voltage measurements.

Absolute Maximum Ratings

Table 3. Absolute maximum ratings for LUXEON XR-M.

PARAMETER	MAXIMUM PERFORMANCE
DC Forward Current ^[1,2]	1050mA
Peak Pulsed Forward Current ^[1,3]	1200mA
LED Junction Temperature ^[1] (DC & Pulse)	135°C
ESD Sensitivity	IEC 61000-4-2 Level 4 (8/15 kV contact/air discharge)
Operating Temperature at T _c point ^[4]	-40 to 85°C
LED Module Storage Temperature	-40 to 105°C
Reverse Voltage (V _{reverse})	LUXEON LEDs are not designed to be driven in reverse bias

Notes for Table 3:

1. Proper current derating must be observed to maintain the junction temperature below the maximum.
2. Residual periodic variations due to power conversion from alternating current (AC) to direct current (DC), also called "ripple," with frequencies ≥100Hz and amplitude ≤15% of the maximum allowable DC forward current are acceptable, assuming the average current throughout each cycle does not exceed the maximum allowable DC Forward Current at the corresponding maximum junction temperature.
3. Pulsed operation with a peak drive current equal to the stated Peak Pulsed Forward Current is acceptable if the pulse on-time is ≤5ms per cycle and the duty cycle is ≤50%.
4. Measured at T_c point next to LED. See AB103 LUXEON M Application Brief for details. Some manufacturers refer to T_c as T_s.
5. Per IEC 62471, Ethr=770 lux.

Characteristic Curves

Spectral Power Distribution Characteristics

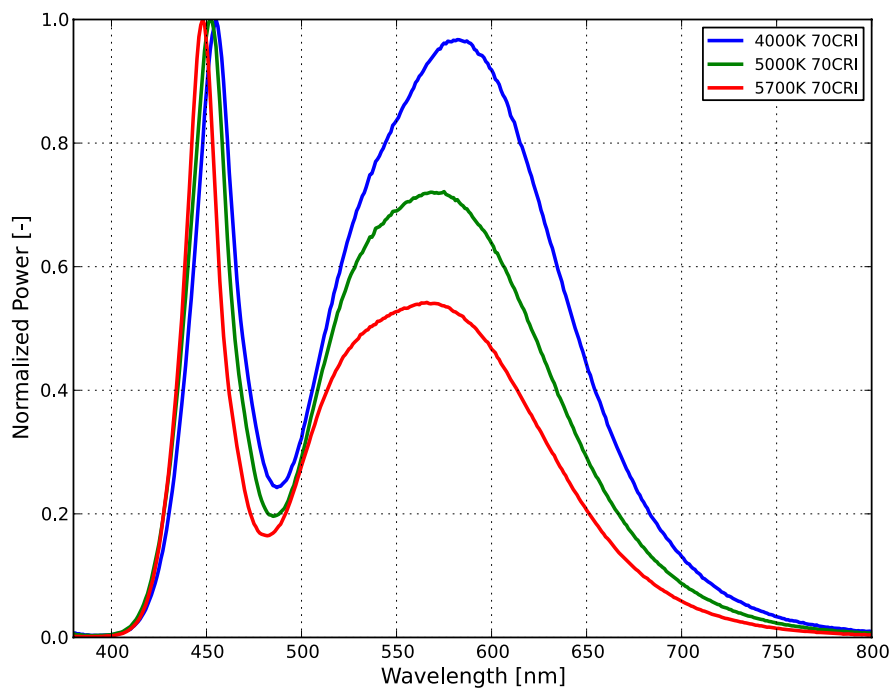

Figure 1: Typical normalized power vs. wavelength for LUXEON M at 700mA, T_J=85°C.

Radiation Pattern Characteristics

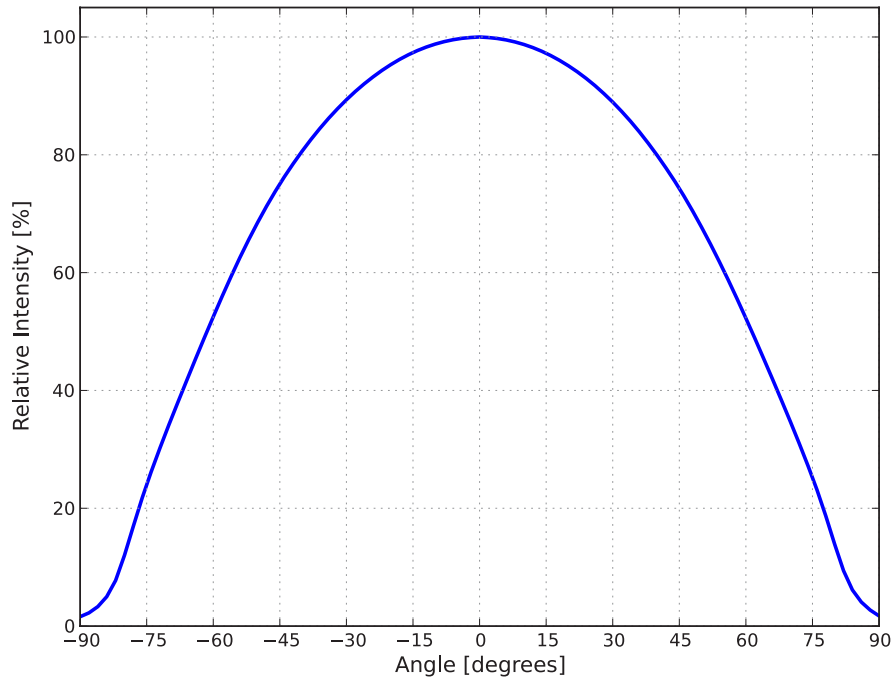

Figure 2: Typical radiation pattern for LUXEON M at 700mA, $T_j=85^{\circ}\text{C}$.

Color Bin Definition

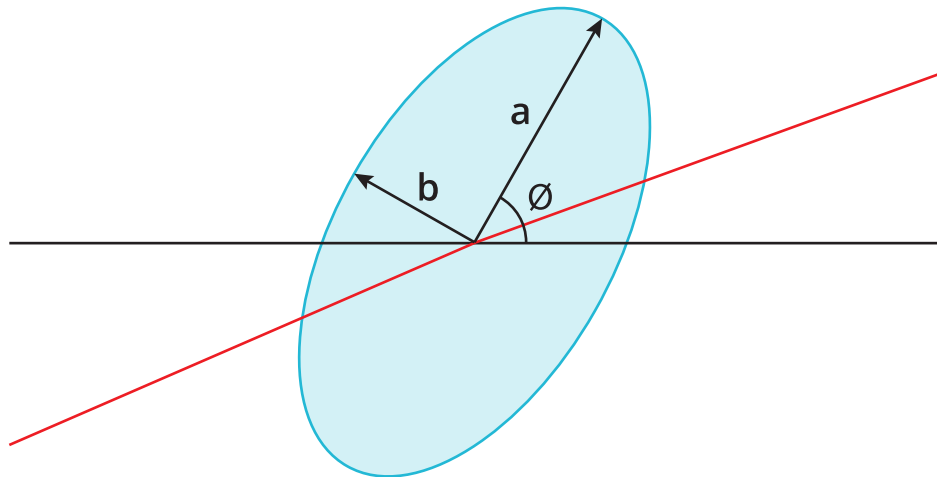

Figure 3: 5-step MacAdam ellipse illustration for Table 4.

Table 4. 5-step MacAdam ellipse color bin definitions for LUXEON M at 700mA, $T_j=85^{\circ}\text{C}$.

NOMINAL CCT	COLOR SPACE	CENTER POINT (cx, cy)	MAJOR AXIS, a	MINOR AXIS, b	ELLIPSE ROTATION ANGLE, θ
4000K	Single 5-step MacAdam ellipse	(0.3818, 0.3797)	0.01565	0.00670	53.72°
5000K	Single 5-step MacAdam ellipse	(0.3447, 0.3553)	0.01370	0.00590	59.62°
5700K	Single 5-step MacAdam ellipse	(0.3287, 0.3417)	0.01243	0.00533	59.09°

Notes for Table 4:

1. Lumileds maintains a tolerance of ± 0.005 on x and y coordinates in the CIE 1931 color space.

Mechanical Dimensions

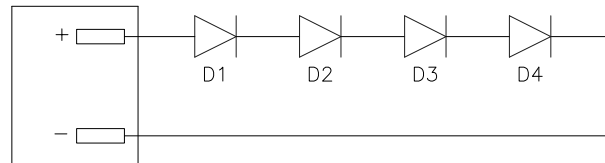
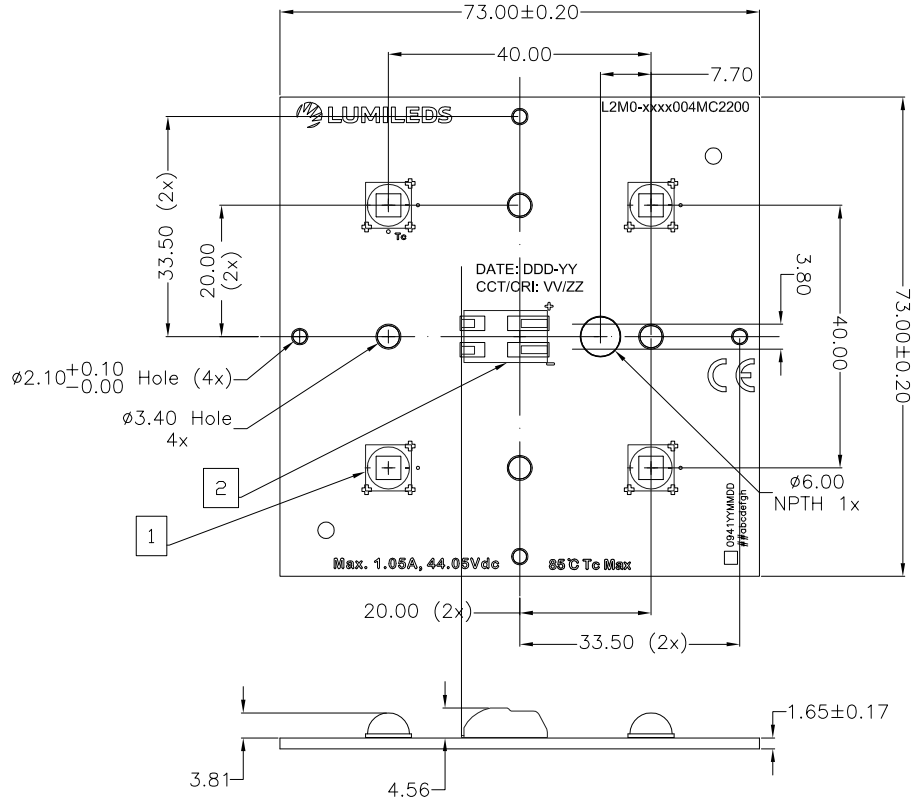

Circuit Diagram

ITEM	QTY	PART/MATERIAL-DESCRIPTION	REFERENCE
1	4	LUXEON M	
2	1	2-pole Connector	

Figure 4: Mechanical dimensions for L2M0-xxxx004MC2200.

Notes for Figure 4:

- 1. Drawings are not to scale.
- 2. All dimensions are in millimeters.

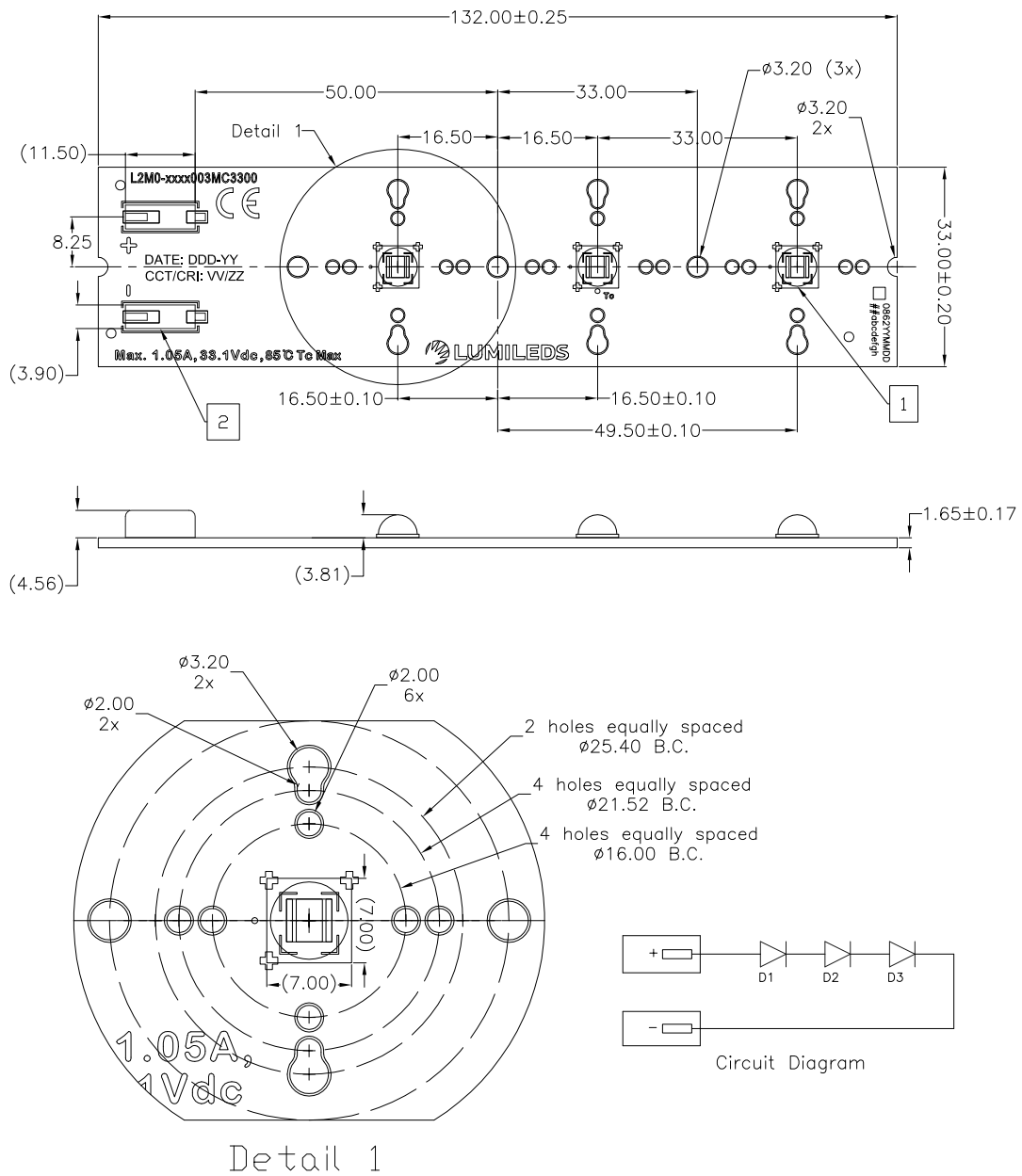
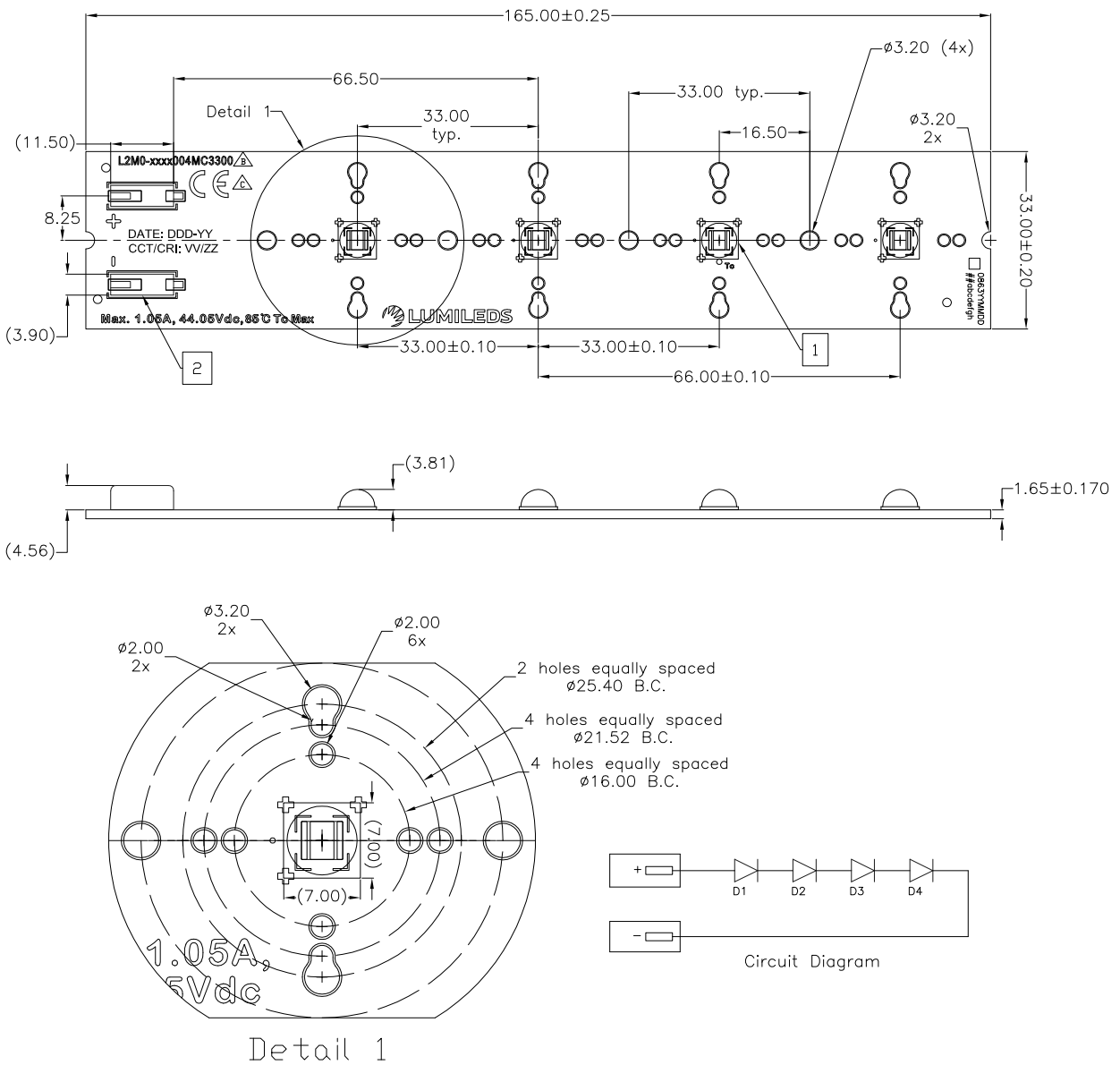

Figure 5: Mechanical dimensions for L2M0-xxxx003MC3300.

Notes for Figure 5:

1. Drawings are not to scale.
2. All dimensions are in millimeters.



Detail 1

ITEM	QTY	PART/MATERIAL-DESCRIPTION	REFERENCE
1	4	LUXEON M	
2	2	1-pole Connector	

Figure 6: Mechanical dimensions for L2M0-xxxx004MC3300.

Notes for Figure 6:

1. Drawings are not to scale.
2. All dimensions are in millimeters.

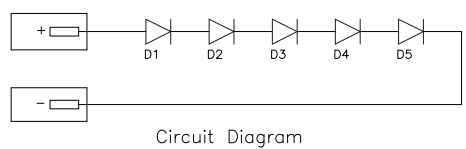
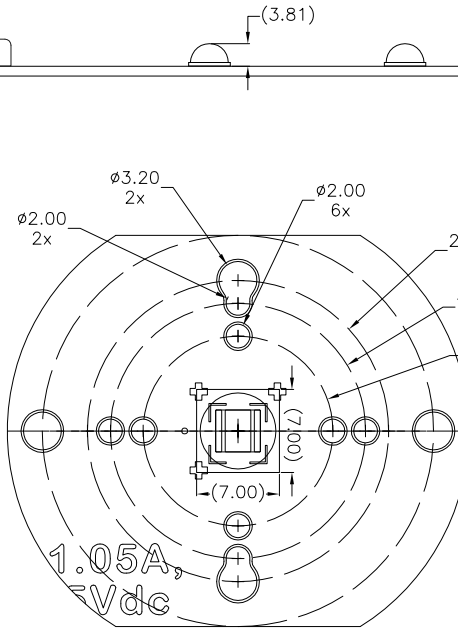
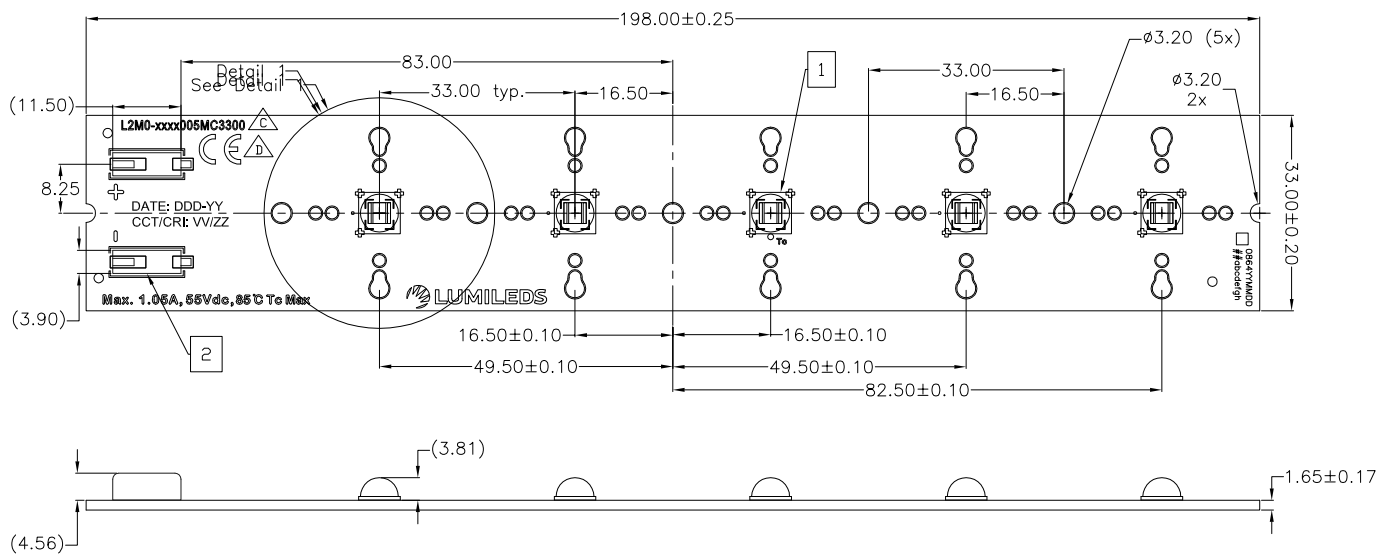

Detail 1

ITEM	QTY	PART/MATERIAL - DESCRIPTION	REFERENCE
1	5	LUXEON M	
2	2	1-pole Connector	

Figure 7: Mechanical dimensions for L2M0-xxxx005MC3300.

Notes for Figure 7:
 1. Drawings are not to scale.
 2. All dimensions are in millimeters.

Packaging Information

Table 5. Packaging information for LUXEON XR-M.

PART NUMBER	TRAY DIMENSIONS (mm)	QUANTITY PER TRAY	NUMBER OF TRAYS PER BOX
L2M0-xxxx004MC2200	450 x 250 x 64	60	1
L2M0-xxxx003MC3300	450 x 185 x 31	30	1
L2M0-xxxx004MC3300	450 x 220 x 31	30	1
L2M0-xxxx005MC3300	450 x 250 x 31	30	1

Tray Dimensions

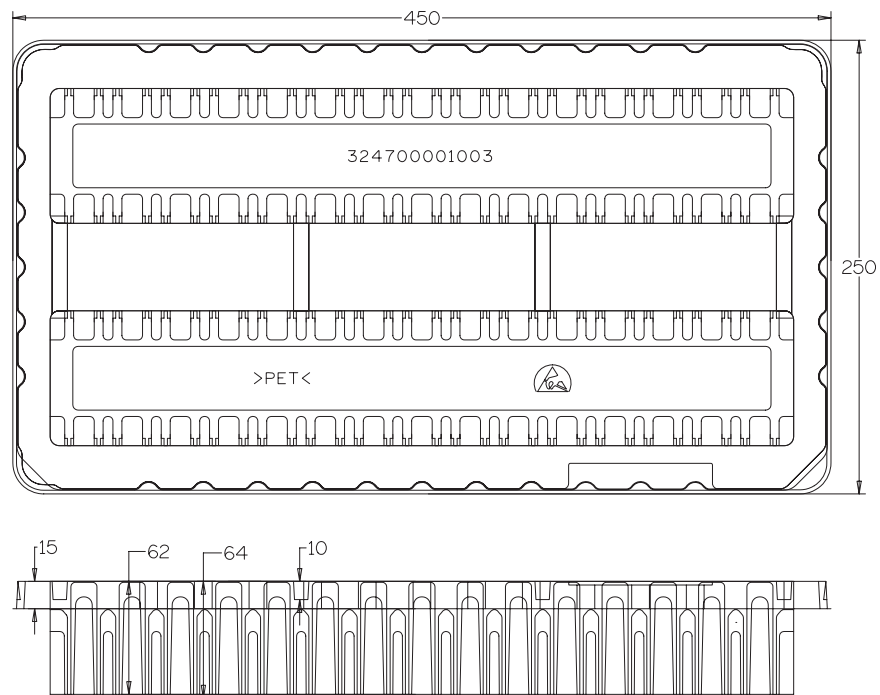

Figure 8: Tray dimensions for L2M0-xxxx004MC2200.

Notes for Figure 8:

1. Drawings are not scale.
2. All dimensions are in millimeters.

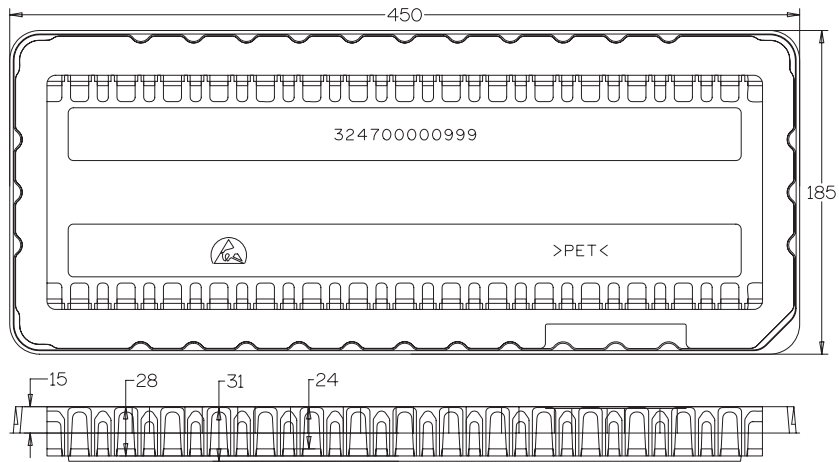

Figure 9: Tray dimensions for L2M0-xxxx003MC3300.

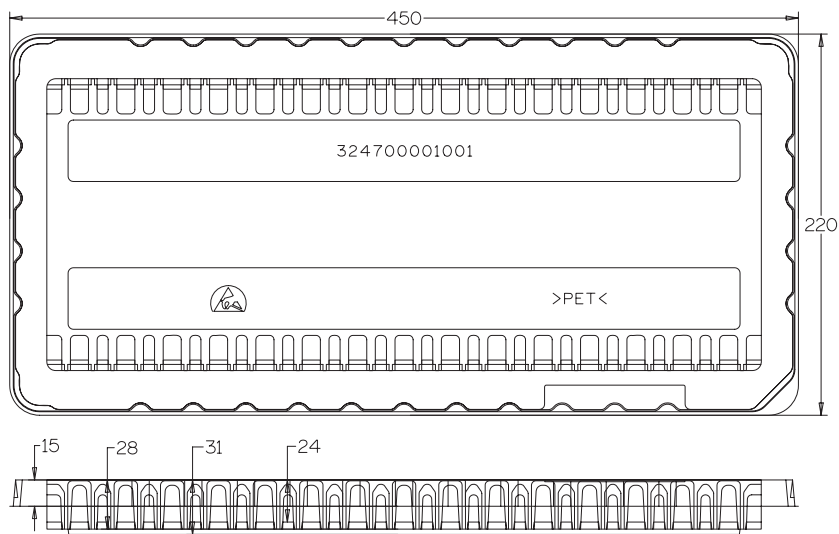

Figure 10: Tray dimensions for L2M0-xxxx004MC3300.

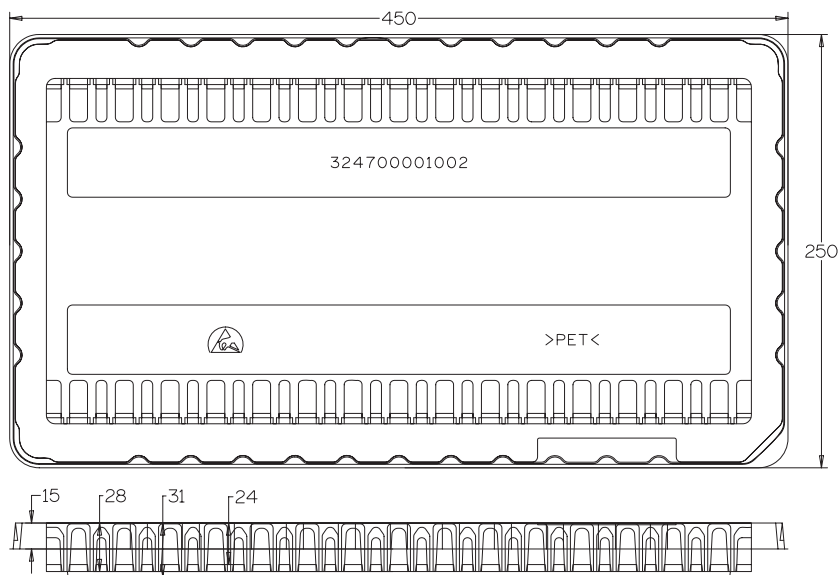

Figure 11: Tray dimensions for L2M0-xxxx005MC3300.

Notes for Figure 9, 10 and 11:
 1. Drawings are not scale.
 2. All dimensions are in millimeters.

Product Packaging Considerations — Chemical Compatibility

The LUXEON M package contains a silicone overcoat and dome to protect the LED chips and extract the maximum amount of light. As with most silicones used in LED optics, care must be taken to prevent any incompatible chemicals from directly or indirectly reacting with the silicone. Refer to the [LUXEON M Application Brief AB103](#) for guidelines on chemical compatibilities.

About Lumileds

Lumileds is the global leader in light engine technology. The company develops, manufactures and distributes groundbreaking LEDs and automotive lighting products that shatter the status quo and help customers gain and maintain a competitive edge. With a rich history of industry “firsts,” Lumileds is uniquely positioned to deliver lighting advancements well into the future by maintaining an unwavering focus on quality, innovation and reliability.

To learn more about our portfolio of light engines, visit lumileds.com.



©2016 Lumileds Holding B.V. All rights reserved.
LUXEON is a registered trademark of the Lumileds Holding B.V.
in the United States and other countries.
lumileds.com

Neither Lumileds Holding B.V. nor its affiliates shall be liable for any kind of loss of data or any other damages, direct, indirect or consequential, resulting from the use of the provided information and data. Although Lumileds Holding B.V. and/or its affiliates have attempted to provide the most accurate information and data, the materials and services information and data are provided “as is,” and neither Lumileds Holding B.V. nor its affiliates warrants or guarantees the contents and correctness of the provided information and data. Lumileds Holding B.V. and its affiliates reserve the right to make changes without notice. You as user agree to this disclaimer and user agreement with the download or use of the provided materials, information and data.



Компания «ЭлектроПласт» предлагает заключение долгосрочных отношений при поставках импортных электронных компонентов на взаимовыгодных условиях!

Наши преимущества:

- Оперативные поставки широкого спектра электронных компонентов отечественного и импортного производства напрямую от производителей и с крупнейших мировых складов;
- Поставка более 17-ти миллионов наименований электронных компонентов;
- Поставка сложных, дефицитных, либо снятых с производства позиций;
- Оперативные сроки поставки под заказ (от 5 рабочих дней);
- Экспресс доставка в любую точку России;
- Техническая поддержка проекта, помощь в подборе аналогов, поставка прототипов;
- Система менеджмента качества сертифицирована по Международному стандарту ISO 9001;
- Лицензия ФСБ на осуществление работ с использованием сведений, составляющих государственную тайну;
- Поставка специализированных компонентов (Xilinx, Altera, Analog Devices, Intersil, Interpoint, Microsemi, Aeroflex, Peregrine, Syfer, Eurofarad, Texas Instrument, Miteq, Cobham, E2V, MA-COM, Hittite, Mini-Circuits, General Dynamics и др.);

Помимо этого, одним из направлений компании «ЭлектроПласт» является направление «Источники питания». Мы предлагаем Вам помощь Конструкторского отдела:

- Подбор оптимального решения, техническое обоснование при выборе компонента;
- Подбор аналогов;
- Консультации по применению компонента;
- Поставка образцов и прототипов;
- Техническая поддержка проекта;
- Защита от снятия компонента с производства.



Как с нами связаться

Телефон: 8 (812) 309 58 32 (многоканальный)

Факс: 8 (812) 320-02-42

Электронная почта: org@eplast1.ru

Адрес: 198099, г. Санкт-Петербург, ул. Калинина, дом 2, корпус 4, литера А.