

74HC14-Q100; 74HCT14-Q100

Hex inverting Schmitt trigger

Rev. 6 — 22 May 2020

Product data sheet

1. General description

The 74HC14-Q100; 74HCT14-Q100 is a hex inverter with Schmitt-trigger inputs. This device features reduced input threshold levels to allow interfacing to TTL logic levels. Inputs also include clamp diodes, this enables the use of current limiting resistors to interface inputs to voltages in excess of V_{CC} . Schmitt trigger inputs transform slowly changing input signals into sharply defined jitter-free output signals.

This product has been qualified to the Automotive Electronics Council (AEC) standard Q100 (Grade 1) and is suitable for use in automotive applications.

2. Features and benefits

- Automotive product qualification in accordance with AEC-Q100 (Grade 1)
 - Specified from -40 °C to +85 °C and from -40 °C to +125 °C
- Complies with JEDEC standard no. 7A
- Low-power dissipation
- ESD protection:
 - MIL-STD-883, method 3015 exceeds 2000 V
 - HBM JESD22-A114F exceeds 2000 V
 - MM JESD22-A115-A exceeds 200 V (C = 200 pF, R = 0 Ω)
- Multiple package options
- DHVQFN package with Side-Wettable Flanks enabling Automatic Optical Inspection (AOI) of solder joints

3. Applications

- Wave and pulse shapers
- Astable multivibrators
- Monostable multivibrators

4. Ordering information

Table 1. Ordering information

Type number	Package			
	Temperature range	Name	Description	Version
74HC14D-Q100	-40 °C to +125 °C	SO14	plastic small outline package; 14 leads; body width 3.9 mm	SOT108-1
74HCT14D-Q100				
74HC14PW-Q100	-40 °C to +125 °C	TSSOP14	plastic thin shrink small outline package; 14 leads; body width 4.4 mm	SOT402-1
74HCT14PW-Q100				
74HC14BQ-Q100	-40 °C to +125 °C	DHVQFN14	plastic dual in-line compatible thermal enhanced very thin quad flat package; no leads; 14 terminals; body 2.5 × 3 × 0.85 mm	SOT762-1
74HCT14BQ-Q100				

5. Functional diagram

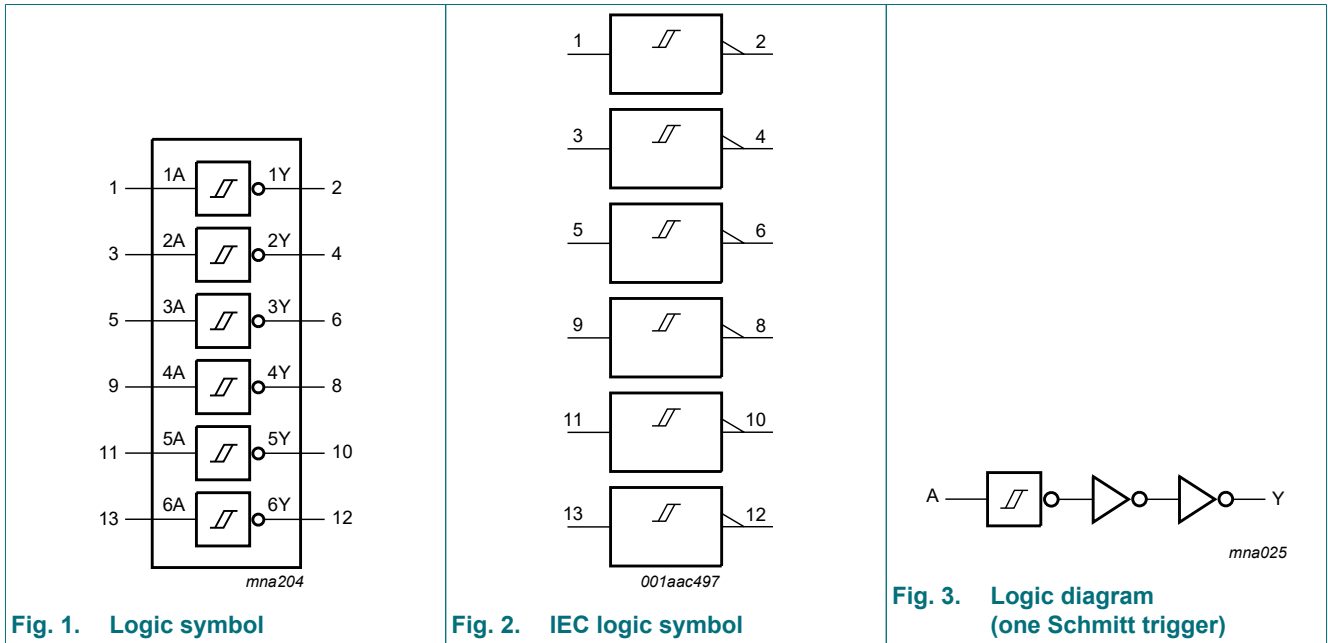

6. Pinning information

6.1. Pinning

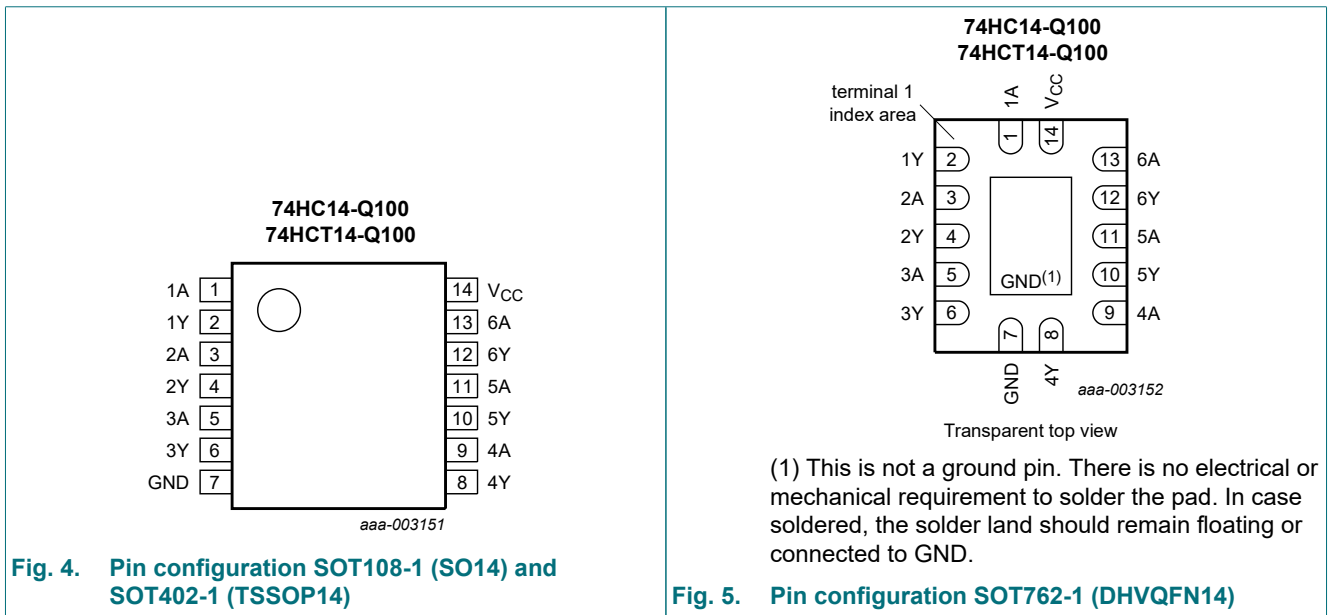

(1) This is not a ground pin. There is no electrical or mechanical requirement to solder the pad. In case soldered, the solder land should remain floating or connected to GND.

6.2. Pin description

Table 2. Pin description

Symbol	Pin	Description
1A, 2A, 3A, 4A, 5A, 6A	1, 3, 5, 9, 11, 13	data input
1Y, 2Y, 3Y, 4Y, 5Y, 6Y	2, 4, 6, 8, 10, 12	data output
GND	7	ground (0 V)
V _{CC}	14	supply voltage

7. Functional description

Table 3. Function table

H = HIGH voltage level; L = LOW voltage level.

Input	Output
nA	nY
L	H
H	L

8. Limiting values

Table 4. Limiting values

In accordance with the Absolute Maximum Rating System (IEC 60134). Voltages are referenced to GND (ground = 0 V).

Symbol	Parameter	Conditions	Min	Max	Unit
V _{CC}	supply voltage		-0.5	+7	V
I _{IK}	input clamping current	V _I < -0.5 V or V _I > V _{CC} + 0.5 V [1]	-	±20	mA
I _{OK}	output clamping current	V _O < -0.5 V or V _O > V _{CC} + 0.5 V [1]	-	±20	mA
I _O	output current	-0.5 V < V _O < V _{CC} + 0.5 V	-	±25	mA
I _{CC}	supply current		-	50	mA
I _{GND}	ground current		-50	-	mA
T _{stg}	storage temperature		-65	+150	°C
P _{tot}	total power dissipation	[2]	-	500	mW

[1] The input and output voltage ratings may be exceeded if the input and output current ratings are observed.

[2] For SOT108-1 (SO14) package: P_{tot} derates linearly with 10.1 mW/K above 100 °C.

For SOT402-1 (TSSOP14) package: P_{tot} derates linearly with 7.3 mW/K above 81 °C.

For SOT762-1 (DHVQFN14) package: P_{tot} derates linearly with 9.6 mW/K above 98 °C.

9. Recommended operating conditions

Table 5. Recommended operating conditions

Voltages are referenced to GND (ground = 0 V)

Symbol	Parameter	Conditions	74HC14-Q100			74HCT14-Q100			Unit
			Min	Typ	Max	Min	Typ	Max	
V _{CC}	supply voltage		2.0	5.0	6.0	4.5	5.0	5.5	V
V _I	input voltage		0	-	V _{CC}	0	-	V _{CC}	V
V _O	output voltage		0	-	V _{CC}	0	-	V _{CC}	V
T _{amb}	ambient temperature		-40	+25	+125	-40	+25	+125	°C

10. Static characteristics

Table 6. Static characteristics

At recommended operating conditions; voltages are referenced to GND (ground = 0 V).

Symbol	Parameter	Conditions	T _{amb} = 25 °C			T _{amb} = -40 °C to +85 °C		T _{amb} = -40 °C to +125 °C		Unit
			Min	Typ	Max	Min	Max	Min	Max	
74HC14-Q100										
V _{OH}	HIGH-level output voltage	V _I = V _{T+} or V _{T-}								
		I _O = -20 μA; V _{CC} = 2.0 V	1.9	2.0	-	1.9	-	1.9	-	V
		I _O = -20 μA; V _{CC} = 4.5 V	4.4	4.5	-	4.4	-	4.4	-	V
		I _O = -20 μA; V _{CC} = 6.0 V	5.9	6.0	-	5.9	-	5.9	-	V
		I _O = -4.0 mA; V _{CC} = 4.5 V	3.98	4.32	-	3.84	-	3.7	-	V
		I _O = -5.2 mA; V _{CC} = 6.0 V	5.48	5.81	-	5.34	-	5.2	-	V
V _{OL}	LOW-level output voltage	V _I = V _{T+} or V _{T-}								
		I _O = 20 μA; V _{CC} = 2.0 V	-	0	0.1	-	0.1	-	0.1	V
		I _O = 20 μA; V _{CC} = 4.5 V	-	0	0.1	-	0.1	-	0.1	V
		I _O = 20 μA; V _{CC} = 6.0 V	-	0	0.1	-	0.1	-	0.1	V
		I _O = 4.0 mA; V _{CC} = 4.5 V	-	0.15	0.26	-	0.33	-	0.4	V
		I _O = 5.2 mA; V _{CC} = 6.0 V	-	0.16	0.26	-	0.33	-	0.4	V
I _I	input leakage current	V _I = V _{CC} or GND; V _{CC} = 6.0 V	-	-	±0.1	-	±1.0	-	±1.0	μA
I _{CC}	supply current	V _I = V _{CC} or GND; I _O = 0 A; V _{CC} = 6.0 V	-	-	2.0	-	20	-	40	μA
C _I	input capacitance		-	3.5	-	-	-	-	-	pF
74HCT14-Q100										
V _{OH}	HIGH-level output voltage	V _I = V _{T+} or V _{T-} ; V _{CC} = 4.5 V								
		I _O = -20 μA	4.4	4.5	-	4.4	-	4.4	-	V
		I _O = -4.0 mA	3.98	4.32	-	3.84	-	3.7	-	V
V _{OL}	LOW-level output voltage	V _I = V _{T+} or V _{T-} ; V _{CC} = 4.5 V								
		I _O = 20 μA;	-	0	0.1	-	0.1	-	0.1	V
		I _O = 4.0 mA;	-	0.15	0.26	-	0.33	-	0.4	V
I _I	input leakage current	V _I = V _{CC} or GND; V _{CC} = 5.5 V	-	-	±0.1	-	±1.0	-	±1.0	μA
I _{CC}	supply current	V _I = V _{CC} or GND; I _O = 0 A; V _{CC} = 5.5 V	-	-	2.0	-	20	-	40	μA
ΔI _{CC}	additional supply current	per input pin; V _I = V _{CC} - 2.1 V; other pins at V _{CC} or GND; I _O = 0 A; V _{CC} = 4.5 V to 5.5 V	-	30	108	-	135	-	147	μA
C _I	input capacitance		-	3.5	-	-	-	-	-	pF

11. Dynamic characteristics

Table 7. Dynamic characteristics

$GND = 0\text{ V}$; $C_L = 50\text{ pF}$; for test circuit see [Fig. 7](#).

Symbol	Parameter	Conditions	$T_{amb} = 25\text{ °C}$			$T_{amb} = -40\text{ °C}$ to $+85\text{ °C}$		$T_{amb} = -40\text{ °C}$ to $+125\text{ °C}$		Unit
			Min	Typ	Max	Min	Max	Min	Max	
74HC14-Q100										
t_{pd}	propagation delay	nA to nY; see Fig. 6 [1]								
		$V_{CC} = 2.0\text{ V}$	-	41	125	-	155	-	190	ns
		$V_{CC} = 4.5\text{ V}$	-	15	25	-	31	-	38	ns
		$V_{CC} = 5.0\text{ V}$; $C_L = 15\text{ pF}$	-	12	-	-	-	-	-	ns
		$V_{CC} = 6.0\text{ V}$	-	12	21	-	26	-	32	ns
t_t	transition time	see Fig. 6 [2]								
		$V_{CC} = 2.0\text{ V}$	-	19	75	-	95	-	110	ns
		$V_{CC} = 4.5\text{ V}$	-	7	15	-	19	-	22	ns
		$V_{CC} = 6.0\text{ V}$	-	6	13	-	15	-	19	ns
C_{PD}	power dissipation capacitance	per package; $V_I = GND$ to V_{CC} [3]	-	7	-	-	-	-	-	pF
74HCT14-Q100										
t_{pd}	propagation delay	nA to nY; see Fig. 6 [1]								
		$V_{CC} = 4.5\text{ V}$	-	20	34	-	43	-	51	ns
		$V_{CC} = 5.0\text{ V}$; $C_L = 15\text{ pF}$	-	17	-	-	-	-	-	ns
t_t	transition time	$V_{CC} = 4.5\text{ V}$; see Fig. 6 [2]	-	7	15	-	19	-	22	ns
C_{PD}	power dissipation capacitance	per package; $V_I = GND$ to $V_{CC} - 1.5\text{ V}$ [3]	-	8	-	-	-	-	-	pF

[1] t_{pd} is the same as t_{PHL} and t_{PLH} .

[2] t_t is the same as t_{THL} and t_{TLH} .

[3] C_{PD} is used to determine the dynamic power dissipation (P_D in μW):

$$P_D = C_{PD} \times V_{CC}^2 \times f_i \times N + \sum (C_L \times V_{CC}^2 \times f_o) \text{ where:}$$

f_i = input frequency in MHz;

f_o = output frequency in MHz;

C_L = output load capacitance in pF;

V_{CC} = supply voltage in V;

N = number of inputs switching;

$\sum (C_L \times V_{CC}^2 \times f_o)$ = sum of outputs.

11.1. Waveforms

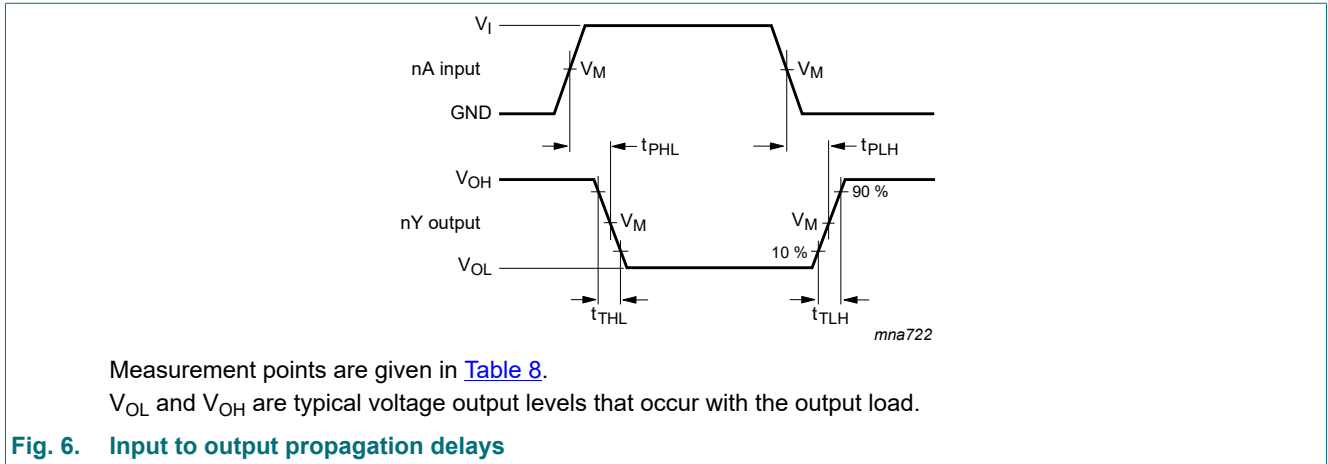

Table 8. Measurement points

Type	Input		Output	
	V_M	V_M	V_X	V_Y
74HC14-Q100	$0.5V_{CC}$	$0.5V_{CC}$	$0.1V_{CC}$	$0.9V_{CC}$
74HCT14-Q100	1.3 V	1.3 V	$0.1V_{CC}$	$0.9V_{CC}$

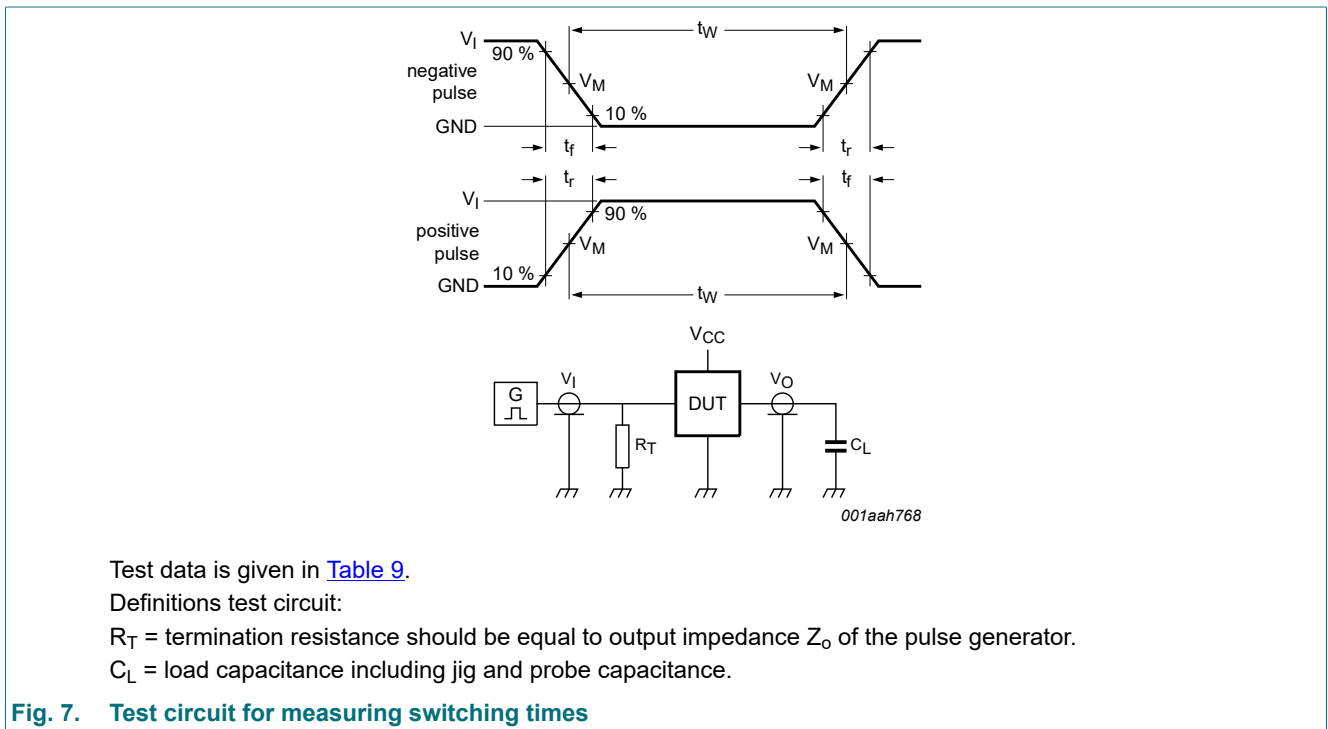

Table 9. Test data

Type	Input		Load	Test
	V_I	t_r, t_f	C_L	
74HC14-Q100	V_{CC}	6.0 ns	15 pF, 50 pF	t_{PLH}, t_{PHL}
74HCT14-Q100	3.0 V	6.0 ns	15 pF, 50 pF	t_{PLH}, t_{PHL}

12. Transfer characteristics

Table 10. Transfer characteristics

At recommended operating conditions; voltages are referenced to GND (ground = 0 V); see Fig. 8 and Fig. 9.

Symbol	Parameter	Conditions	T _{amb} = 25 °C			T _{amb} = -40 °C to +85 °C		T _{amb} = -40 °C to +125 °C		Unit
			Min	Typ	Max	Min	Max	Min	Max	
74HC14-Q100										
V _{T+}	positive-going threshold voltage	V _{CC} = 2.0 V	0.7	1.18	1.5	0.7	1.5	0.7	1.5	V
		V _{CC} = 4.5 V	1.7	2.38	3.15	1.7	3.15	1.7	3.15	V
		V _{CC} = 6.0 V	2.1	3.14	4.2	2.1	4.2	2.1	4.2	V
V _{T-}	negative-going threshold voltage	V _{CC} = 2.0 V	0.3	0.52	0.9	0.3	0.9	0.3	0.9	V
		V _{CC} = 4.5 V	0.9	1.4	2.0	0.9	2.0	0.9	2.0	V
		V _{CC} = 6.0 V	1.2	1.89	2.6	1.2	2.6	1.2	2.6	V
V _H	hysteresis voltage	V _{CC} = 2.0 V	0.2	0.66	1.0	0.2	1.0	0.2	1.0	V
		V _{CC} = 4.5 V	0.4	0.98	1.4	0.4	1.4	0.4	1.4	V
		V _{CC} = 6.0 V	0.6	1.25	1.6	0.6	1.6	0.6	1.6	V
74HCT14-Q100										
V _{T+}	positive-going threshold voltage	V _{CC} = 4.5 V	1.2	1.41	1.9	1.2	1.9	1.2	1.9	V
		V _{CC} = 5.5 V	1.4	1.59	2.1	1.4	2.1	1.4	2.1	V
V _{T-}	negative-going threshold voltage	V _{CC} = 4.5 V	0.5	0.85	1.2	0.5	1.2	0.5	1.2	V
		V _{CC} = 5.5 V	0.6	0.99	1.4	0.6	1.4	0.6	1.4	V
V _H	hysteresis voltage	V _{CC} = 4.5 V	0.4	0.56	-	0.4	-	0.4	-	V
		V _{CC} = 5.5 V	0.4	0.6	-	0.4	-	0.4	-	V

12.1. Transfer characteristics waveforms

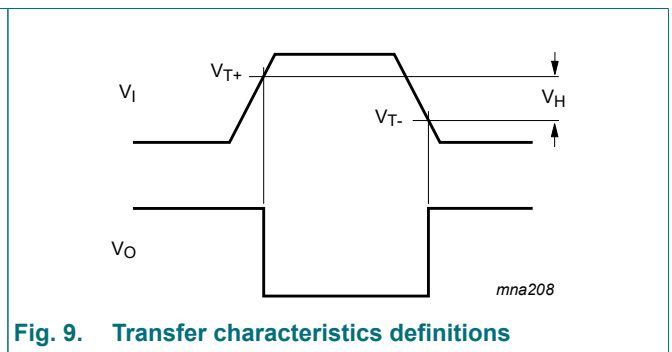
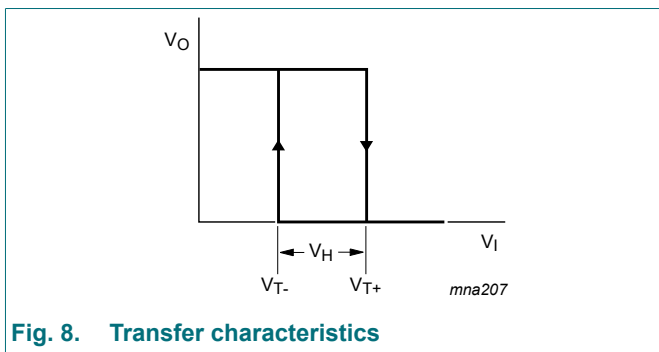

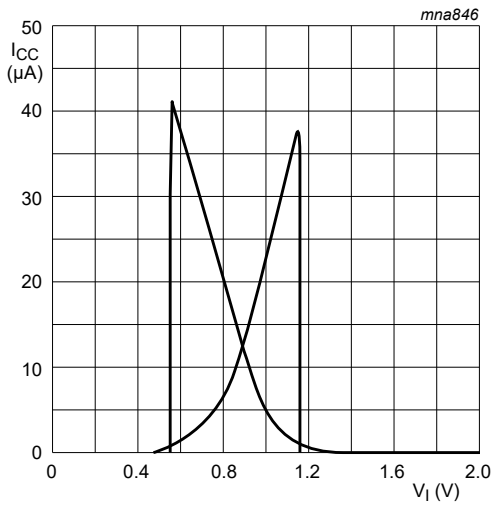

a. $V_{CC} = 2.0\text{ V}$

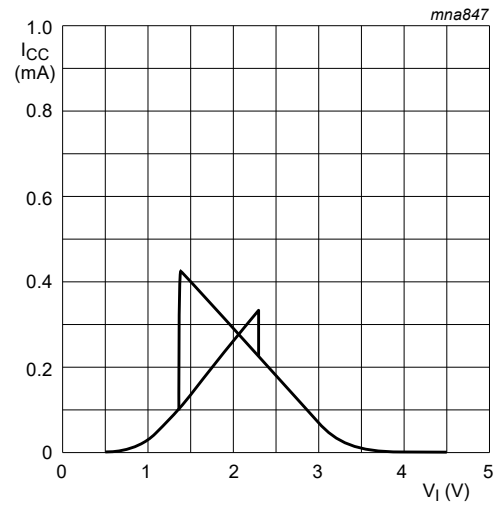

b. $V_{CC} = 4.5\text{ V}$

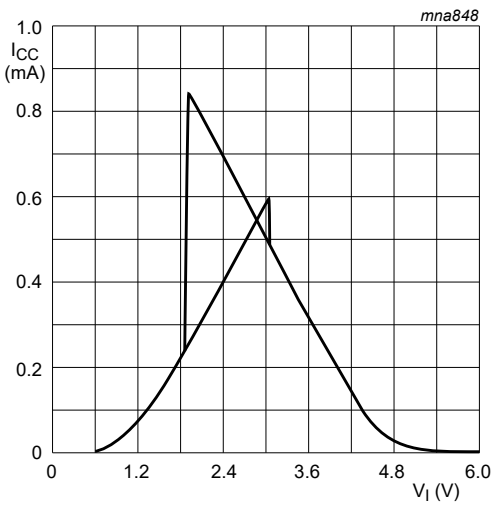

c. $V_{CC} = 6.0\text{ V}$

Fig. 10. Typical 74HC transfer characteristics

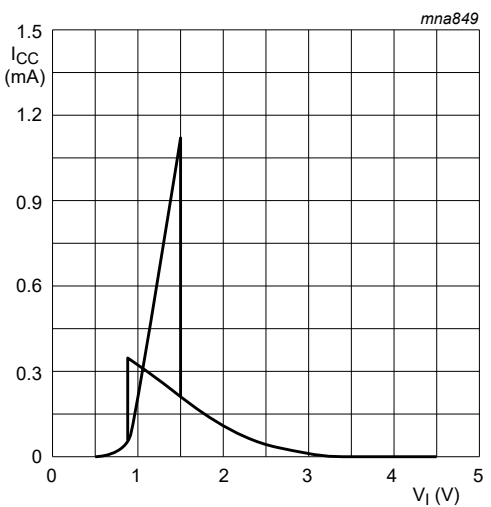

a. $V_{CC} = 4.5\text{ V}$

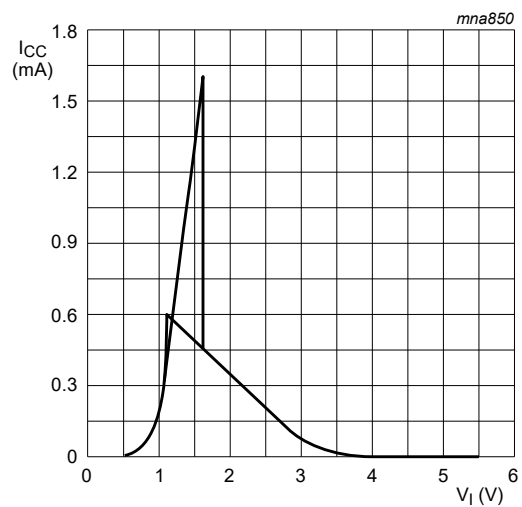

b. $V_{CC} = 5.5\text{ V}$

Fig. 11. Typical 74HCT transfer characteristics

13. Application information

The slow input rise and fall times cause additional power dissipation, this can be calculated using the following formula:

$$P_{add} = f_i \times (t_r \times \Delta I_{CC(AV)} + t_f \times \Delta I_{CC(AV)}) \times V_{CC} \text{ where:}$$

- P_{add} = additional power dissipation (μW);
- f_i = input frequency (MHz);
- t_r = rise time (ns); 10 % to 90 %;
- t_f = fall time (ns); 90 % to 10 %;
- $\Delta I_{CC(AV)}$ = average additional supply current (μA).

Average $\Delta I_{CC(AV)}$ differs with positive or negative input transitions, as shown in Fig. 12 and Fig. 13.

An example of a relaxation circuit using the 74HC14-Q100; 74HCT14-Q100 is shown in Fig. 14.

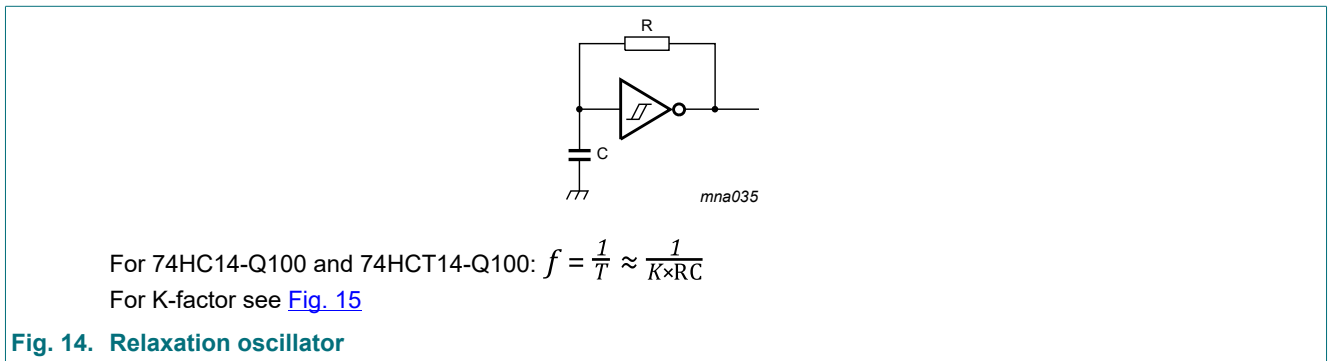
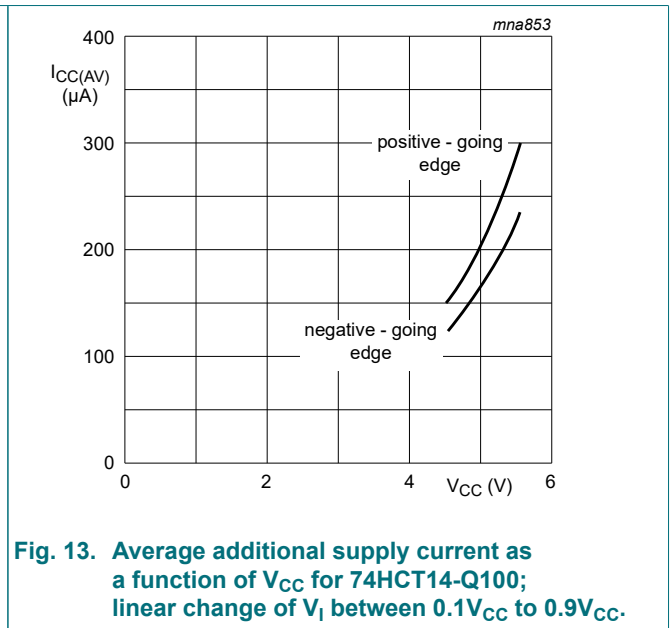
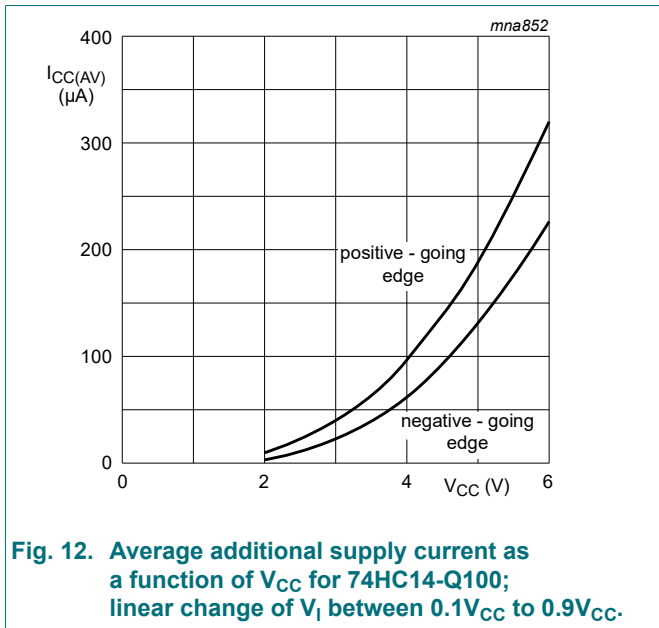

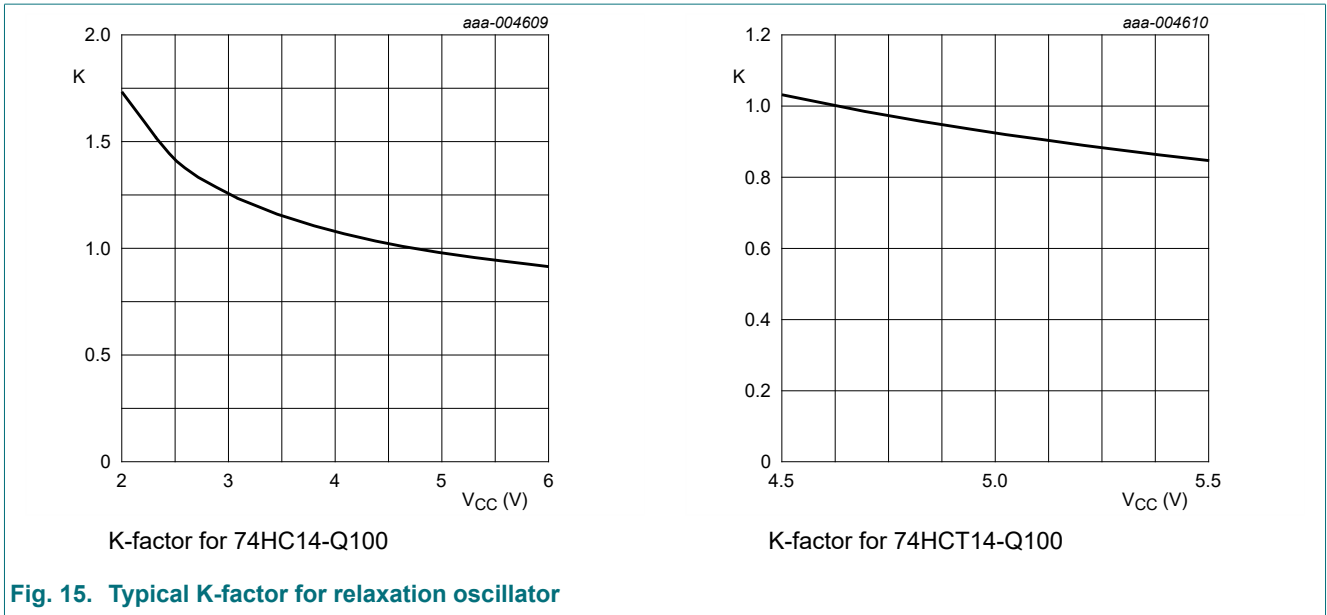

14. Package outline

SO14: plastic small outline package; 14 leads; body width 3.9 mm

SOT108-1



Fig. 16. Package outline SOT108-1 (SO14)

TSSOP14: plastic thin shrink small outline package; 14 leads; body width 4.4 mm

SOT402-1



Fig. 17. Package outline SOT402-1 (TSSOP14)

DHVQFN14: plastic dual in-line compatible thermal enhanced very thin quad flat package; no leads; 14 terminals; body 2.5 x 3 x 0.85 mm

SOT762-1



Fig. 18. Package outline SOT762-1 (DHVQFN14)

15. Abbreviations

Table 11. Abbreviations

Acronym	Description
DUT	Device Under Test
ESD	ElectroStatic Discharge
HBM	Human Body Model
MIL	Military
MM	Machine Model
TTL	Transistor-Transistor Logic

16. Revision history

Table 12. Revision history

Document ID	Release date	Data sheet status	Change notice	Supersedes
74HC_HCT14_Q100 v.6	20200522	Product data sheet	-	74HC_HCT14_Q100 v.5
Modifications:	<ul style="list-style-type: none"> The format of this data sheet has been redesigned to comply with the identity guidelines of Nexperia. Legal texts have been adapted to the new company name where appropriate. Section 2 updated. Table 4: Derating values for P_{tot} total power dissipation updated. 			
74HC_HCT14_Q100 v.5	20151201	Product data sheet	-	74HC_HCT14_Q100 v.4
Modifications:	<ul style="list-style-type: none"> Type number 74HC14N-Q100 (SOT27-1) removed. 			
74HC_HCT14_Q100 v.4	20130419	Product data sheet	-	74HC_HCT14_Q100 v.3
Modifications:	<ul style="list-style-type: none"> 74HCT14N-Q100 removed. 			
74HC_HCT14_Q100 v.3	20130410	Product data sheet	-	74HC_HCT14_Q100 v.2
Modifications:	<ul style="list-style-type: none"> 74HC14N-Q100 and 74HCT14N-Q100 added. 			
74HC_HCT14_Q100 v.2	20120810	Product data sheet	-	74HC_HCT14_Q100 v.1
Modifications:	<ul style="list-style-type: none"> Fig. 15 added (typical K-factor for relaxation oscillator). 			
74HC_HCT14_Q100 v.1	20120709	Product data sheet	-	-

17. Legal information

Data sheet status

Document status [1][2]	Product status [3]	Definition
Objective [short] data sheet	Development	This document contains data from the objective specification for product development.
Preliminary [short] data sheet	Qualification	This document contains data from the preliminary specification.
Product [short] data sheet	Production	This document contains the product specification.

- [1] Please consult the most recently issued document before initiating or completing a design.
- [2] The term 'short data sheet' is explained in section "Definitions".
- [3] The product status of device(s) described in this document may have changed since this document was published and may differ in case of multiple devices. The latest product status information is available on the internet at <https://www.nexperia.com>.

Definitions

Draft — The document is a draft version only. The content is still under internal review and subject to formal approval, which may result in modifications or additions. Nexperia does not give any representations or warranties as to the accuracy or completeness of information included herein and shall have no liability for the consequences of use of such information.

Short data sheet — A short data sheet is an extract from a full data sheet with the same product type number(s) and title. A short data sheet is intended for quick reference only and should not be relied upon to contain detailed and full information. For detailed and full information see the relevant full data sheet, which is available on request via the local Nexperia sales office. In case of any inconsistency or conflict with the short data sheet, the full data sheet shall prevail.

Product specification — The information and data provided in a Product data sheet shall define the specification of the product as agreed between Nexperia and its customer, unless Nexperia and customer have explicitly agreed otherwise in writing. In no event however, shall an agreement be valid in which the Nexperia product is deemed to offer functions and qualities beyond those described in the Product data sheet.

Disclaimers

Limited warranty and liability — Information in this document is believed to be accurate and reliable. However, Nexperia does not give any representations or warranties, expressed or implied, as to the accuracy or completeness of such information and shall have no liability for the consequences of use of such information. Nexperia takes no responsibility for the content in this document if provided by an information source outside of Nexperia.

In no event shall Nexperia be liable for any indirect, incidental, punitive, special or consequential damages (including - without limitation - lost profits, lost savings, business interruption, costs related to the removal or replacement of any products or rework charges) whether or not such damages are based on tort (including negligence), warranty, breach of contract or any other legal theory.

Notwithstanding any damages that customer might incur for any reason whatsoever, Nexperia's aggregate and cumulative liability towards customer for the products described herein shall be limited in accordance with the Terms and conditions of commercial sale of Nexperia.

Right to make changes — Nexperia reserves the right to make changes to information published in this document, including without limitation specifications and product descriptions, at any time and without notice. This document supersedes and replaces all information supplied prior to the publication hereof.

Suitability for use in automotive applications — This Nexperia product has been qualified for use in automotive applications. Unless otherwise agreed in writing, the product is not designed, authorized or warranted to be suitable for use in life support, life-critical or safety-critical systems or

equipment, nor in applications where failure or malfunction of an Nexperia product can reasonably be expected to result in personal injury, death or severe property or environmental damage. Nexperia and its suppliers accept no liability for inclusion and/or use of Nexperia products in such equipment or applications and therefore such inclusion and/or use is at the customer's own risk.

Quick reference data — The Quick reference data is an extract of the product data given in the Limiting values and Characteristics sections of this document, and as such is not complete, exhaustive or legally binding.

Applications — Applications that are described herein for any of these products are for illustrative purposes only. Nexperia makes no representation or warranty that such applications will be suitable for the specified use without further testing or modification.

Customers are responsible for the design and operation of their applications and products using Nexperia products, and Nexperia accepts no liability for any assistance with applications or customer product design. It is customer's sole responsibility to determine whether the Nexperia product is suitable and fit for the customer's applications and products planned, as well as for the planned application and use of customer's third party customer(s). Customers should provide appropriate design and operating safeguards to minimize the risks associated with their applications and products.

Nexperia does not accept any liability related to any default, damage, costs or problem which is based on any weakness or default in the customer's applications or products, or the application or use by customer's third party customer(s). Customer is responsible for doing all necessary testing for the customer's applications and products using Nexperia products in order to avoid a default of the applications and the products or of the application or use by customer's third party customer(s). Nexperia does not accept any liability in this respect.

Limiting values — Stress above one or more limiting values (as defined in the Absolute Maximum Ratings System of IEC 60134) will cause permanent damage to the device. Limiting values are stress ratings only and (proper) operation of the device at these or any other conditions above those given in the Recommended operating conditions section (if present) or the Characteristics sections of this document is not warranted. Constant or repeated exposure to limiting values will permanently and irreversibly affect the quality and reliability of the device.

Terms and conditions of commercial sale — Nexperia products are sold subject to the general terms and conditions of commercial sale, as published at <http://www.nexperia.com/profile/terms>, unless otherwise agreed in a valid written individual agreement. In case an individual agreement is concluded only the terms and conditions of the respective agreement shall apply. Nexperia hereby expressly objects to applying the customer's general terms and conditions with regard to the purchase of Nexperia products by customer.

No offer to sell or license — Nothing in this document may be interpreted or construed as an offer to sell products that is open for acceptance or the grant, conveyance or implication of any license under any copyrights, patents or other industrial or intellectual property rights.

Export control — This document as well as the item(s) described herein may be subject to export control regulations. Export might require a prior authorization from competent authorities.

Translations — A non-English (translated) version of a document is for reference only. The English version shall prevail in case of any discrepancy between the translated and English versions.

Trademarks

Notice: All referenced brands, product names, service names and trademarks are the property of their respective owners.

Contents

1. General description	1
2. Features and benefits	1
3. Applications	1
4. Ordering information	1
5. Functional diagram	2
6. Pinning information	2
6.1. Pinning.....	2
6.2. Pin description.....	3
7. Functional description	3
8. Limiting values	3
9. Recommended operating conditions	3
10. Static characteristics	4
11. Dynamic characteristics	5
11.1. Waveforms.....	6
12. Transfer characteristics	7
12.1. Transfer characteristics waveforms.....	7
13. Application information	9
14. Package outline	11
15. Abbreviations	14
16. Revision history	14
17. Legal information	15

© Nexperia B.V. 2020. All rights reserved

For more information, please visit: <http://www.nexperia.com>
For sales office addresses, please send an email to: salesaddresses@nexperia.com
Date of release: 22 May 2020



Компания «ЭлектроПласт» предлагает заключение долгосрочных отношений при поставках импортных электронных компонентов на взаимовыгодных условиях!

Наши преимущества:

- Оперативные поставки широкого спектра электронных компонентов отечественного и импортного производства напрямую от производителей и с крупнейших мировых складов;
- Поставка более 17-ти миллионов наименований электронных компонентов;
- Поставка сложных, дефицитных, либо снятых с производства позиций;
- Оперативные сроки поставки под заказ (от 5 рабочих дней);
- Экспресс доставка в любую точку России;
- Техническая поддержка проекта, помощь в подборе аналогов, поставка прототипов;
- Система менеджмента качества сертифицирована по Международному стандарту ISO 9001;
- Лицензия ФСБ на осуществление работ с использованием сведений, составляющих государственную тайну;
- Поставка специализированных компонентов (Xilinx, Altera, Analog Devices, Intersil, Interpoint, Microsemi, Aeroflex, Peregrine, Syfer, Eurofarad, Texas Instrument, Miteq, Cobham, E2V, MA-COM, Hittite, Mini-Circuits, General Dynamics и др.);

Помимо этого, одним из направлений компании «ЭлектроПласт» является направление «Источники питания». Мы предлагаем Вам помощь Конструкторского отдела:

- Подбор оптимального решения, техническое обоснование при выборе компонента;
- Подбор аналогов;
- Консультации по применению компонента;
- Поставка образцов и прототипов;
- Техническая поддержка проекта;
- Защита от снятия компонента с производства.



Как с нами связаться

Телефон: 8 (812) 309 58 32 (многоканальный)

Факс: 8 (812) 320-02-42

Электронная почта: org@eplast1.ru

Адрес: 198099, г. Санкт-Петербург, ул. Калинина, дом 2, корпус 4, литера А.