

# LFA10F

① LF ② A ③ 10 ④ F ⑤ -□ ⑥ -□



Recommended EMI/EMC Filter  
NAC-04-472



High voltage pulse noise type : NAP series  
Low leakage current type : NAM series  
\*The EMI/EMC Filter is recommended to connect with several devices.

- ① Series name
- ② Single output
- ③ Output wattage
- ④ Universal input
- ⑤ Output voltage
- ⑥ Optional
- C : with Coating
- G : Low leakage current
- J1 : VH(J.S.T.)connector type
- S : with Chassis
- SN : with Chassis & cover
- Y : with Potentiometer

Specification is changed at option, refer to Instruction Manual.

This power supply is manufactured by SMD technology. The stress to P.C.B like twisting or bending causes the defect of the unit, so handle the unit with care.

MODEL	LFA10F-3R3-Y	LFA10F-5	LFA10F-12	LFA10F-15	LFA10F-24
MAX OUTPUT WATTAGE[W]	6.6	10	10.8	10.5	12
DC OUTPUT	3.3V 2A	5V 2A	12V 0.9A	15V 0.7A	24V 0.5A

## SPECIFICATIONS

	MODEL	LFA10F-3R3-Y	LFA10F-5	LFA10F-12	LFA10F-15	LFA10F-24	
INPUT	VOLTAGE[V]	AC85 - 264 1 φ (Refer to Instruction Manual 1.1 and 3.2) *3					
	CURRENT[A]	ACIN 100V	0.18typ (Io=100%)	0.26typ (Io=100%)			
		ACIN 200V	0.11typ (Io=100%)	0.16typ (Io=100%)			
	FREQUENCY[Hz]	50 / 60 (47 - 440)					
	EFFICIENCY[%]	ACIN 100V	68.0typ	74.0typ	76.5typ	77.5typ	79.5typ
		ACIN 200V	68.5typ	76.0typ	79.0typ	80.0typ	83.0typ
INRUSH CURRENT[A]	ACIN 100V	15typ (Io=100%)					
	ACIN 200V	30typ (Io=100%)					
	LEAKAGE CURRENT[ma]	0.15/0.30max (ACIN 100V / 240V 60Hz, Io=100%, According to IEC60950-1 and DEN-AN)					
OUTPUT	VOLTAGE[V]	3.3	5	12	15	24	
	CURRENT[A]	2.0	2.0	0.9	0.7	0.5	
	LINE REGULATION[mV]	*5 20max	20max	48max	60max	96max	
	LOAD REGULATION[mV]	*5 40max	40max	100max	120max	150max	
	RIPPLE[mVp-p]	0 to +50°C	80max	80max	120max	120max	120max
		-10 - 0°C	140max	140max	160max	160max	160max
		Io=0 - 35%	190max	160max	240max	240max	280max
	RIPPLE NOISE[mVp-p]	0 to +50°C	120max	120max	150max	150max	150max
		-10 - 0°C	160max	160max	180max	180max	180max
		Io=0 - 35%	240max	240max	300max	300max	320max
	TEMPERATURE REGULATION[mV]	0 to +50°C	50max	50max	120max	150max	240max
		-10 to +50°C	60max	60max	150max	180max	290max
	DRIFT[mV]	*2 20max	20max	48max	60max	96max	
START-UP TIME[ms]	200typ (ACIN 100V, Io=100%) * Start-up time is 700ms typ for less than 1 minute of applying input again from turning off the input voltage.						
HOLD-UP TIME[ms]	20typ (ACIN 100V, Io=100%)						
OUTPUT VOLTAGE ADJUSTMENT RANGE[V]	2.85 to 3.63	Fixed ("Y"option is available for adjusting output voltage between ±10%)					
OUTPUT VOLTAGE SETTING[V]	3.30 to 3.40	4.90 to 5.30	11.50 to 12.50	14.40 to 15.60	23.00 to 25.00		
PROTECTION CIRCUIT AND OTHERS	OVERCURRENT PROTECTION	Works over 105% of rating and recovers automatically					
	OVERVOLTAGE PROTECTION	4.00 to 5.25	5.75 to 7.00	13.80 to 16.80	17.25 to 21.00	27.60 to 33.60	
	OPERATING INDICATION	Not provided					
	REMOTE SENSING	Not provided					
	REMOTE ON/OFF	Not provided					
ISOLATION	INPUT-OUTPUT	AC3,000V 1minute, Cutoff current = 10mA, DC500V 50MΩ min (At Room Temperature)					
	INPUT-FG	AC2,000V 1minute, Cutoff current = 10mA, DC500V 50MΩ min (At Room Temperature)					
	OUTPUT-FG	AC500V 1minute, Cutoff current = 25mA, DC500V 50MΩ min (At Room Temperature)					
ENVIRONMENT	OPERATING TEMP., HUMID. AND ALTIITUDE	-10 to +70°C, 20 - 90%RH (Non condensing) (Refer to Instruction Manual 3.2), 3,000m (10,000 feet) max *3					
	STORAGE TEMP., HUMID. AND ALTIITUDE	-20 to +75°C, 20 - 90%RH (Non condensing), 9,000m (30,000 feet) max					
	VIBRATION	10 - 55Hz, 19.6m/s <sup>2</sup> (2G), 3minutes period, 60minutes each along X, Y and Z axis					
	IMPACT	196.1m/s <sup>2</sup> (20G), 11ms, once each X, Y and Z axis					
SAFETY AND NOISE REGULATIONS	AGENCY APPROVALS	UL60950-1, C-UL (CSA60950-1), EN60950-1, EN60065, EN50178 Complies with DEN-AN					
	CONDUCTED NOISE	Complies with FCC-B, VCCI-B, CISPR-B, EN55011-B, EN55022-B					
	HARMONIC ATTENUATOR	Complies with IEC61000-3-2 (Class A) *6 (Not built-in to active filter) *4					
OTHERS	CASE SIZE/WEIGHT	50 X 22 X 73.5mm [1.97 X 0.87 X 2.89 inches] (W X H X D) / 55g max (with chassis & cover : 150g max)					
	COOLING METHOD	Convection (Refer to Instruction Manual 3.1 and 3.2) *3					

\*1 This is the value that measured on measuring board with capacitor of 22 μF at 150mm from output terminal. Measured by 20MHz oscilloscope or Ripple-Noise meter (Equivalent to KEISOKU-GIKEN: RM103). A circuit reducing standby power is built in this unit. Therefore, the internal switch element is intermittent operated, and the Ripple/Ripple Noise specification in load

factor Io=0-35% is different. Please refer to the Instruction Manual 1.7.  
\*2 Drift is the change in DC output for an eight hour period after a half-hour warm-up at 25°C, with the input voltage held constant at the rated input/output. Derating is required.  
\*3 When two or more units are operating it may not comply with the IEC61000-3-2.

Please contact us for details.  
\*5 Please contact us about dynamic load and input response.  
\*6 Please contact us about another class.  
\* To meet the specifications. Do not operate over-loaded condition. Parallel operation is not possible.  
\* Derating is required when operated with chassis and cover.  
\* Sound noise may be generated by power supply in case of pulse load.

## Block diagram



LFA

## External view



※ The back side of P.C.B. of the power supply is assembled some SMDs.

Be attention not to bump against the attached area by vibration.

※ Use the spacer of 8mm length or more regarding insulation.

And do not use press-fitting bush.

※ Point A, Point B are thermometry points. Please refer to Instruction Manual 3.

I/O Connector	Mating connector	Terminal
CN1	1-1123724-3	Chain 1123721-1
		Loose 1318912-1
CN2	1-1123723-2	Chain 1123721-1
		Loose 1318912-1

(Mfr:Tyco Electronics)

※ I/O Connector is Mfr. Tyco Electronics

※ Option:-J1:(J.S.T) connector type. Refer to Instruction Manual 5.

### <PIN CONNECTION>

#### CN1

Pin No.	Input
1	AC(L)
2	
3	AC(N)
4	
5	FG

#### CN2

Pin No.	Output
1	-V
2	+V

※ Tolerance :  $\pm 1$  [ $\pm 0.04$ ]

※ Weight : 55g max (with chassis & cover : 150g max)

※ PCB material / thickness : CEM3 / 1.6mm

※ Optional chassis and cover material : Electric galvanizing steel board.

※ Dimensions in mm, [ ]=inches

※ Mounting torque (Mounting hole of chassis) :  $0.6N \cdot m$  (6.3kgf · cm) max

# LFA15F

LF A 15 F -□ -□  
 ① ② ③ ④ ⑤ ⑥



RoHS

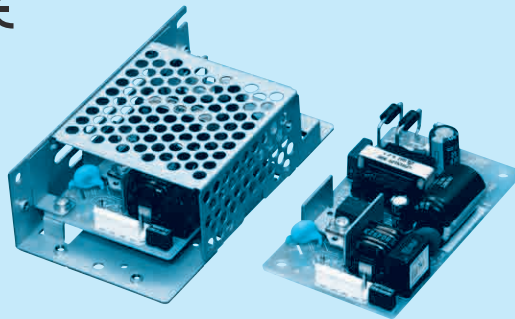

Recommended EMI/EMC Filter  
**NAC-04-472**



High voltage pulse noise type : NAP series  
 Low leakage current type : NAM series  
 \*The EMI/EMC Filter is recommended to connect with several devices.

- ① Series name
- ② Single output
- ③ Output wattage
- ④ Universal input
- ⑤ Output voltage
- ⑥ Optional
- C : with Coating
- G : Low leakage current
- J1 : VH(J.S.T.)connector type
- S : with Chassis
- SN : with Chassis & cover
- Y : with Potentiometer

Specification is changed at option, refer to Instruction Manual.

This power supply is manufactured by SMD technology. The stress to P.C.B like twisting or bending causes the defect of the unit, so handle the unit with care.

MODEL	LFA15F-3R3-Y	LFA15F-5	LFA15F-12	LFA15F-15	LFA15F-24
MAX OUTPUT WATTAGE[W]	9.9	15	15.6	15	16.8
DC OUTPUT	3.3V 3A	5V 3A	12V 1.3A	15V 1A	24V 0.7A

## SPECIFICATIONS

	MODEL	LFA15F-3R3-Y	LFA15F-5	LFA15F-12	LFA15F-15	LFA15F-24	
INPUT	VOLTAGE[V]	AC85 - 264 1 φ (Refer to Instruction Manual 1.1 and 3.2) *3					
	CURRENT[A]	ACIN 100V	0.24typ (Io=100%)	0.35typ (Io=100%)			
		ACIN 200V	0.15typ (Io=100%)	0.20typ (Io=100%)			
	FREQUENCY[Hz]	50 / 60 (47 - 440)					
	EFFICIENCY[%]	ACIN 100V	68.0typ	73.0typ	76.0typ	77.0typ	78.0typ
		ACIN 200V	69.0typ	76.0typ	78.5typ	80.0typ	81.5typ
INRUSH CURRENT[A]	ACIN 100V	15typ (Io=100%) (At cold start) (Ta=25°C)					
	ACIN 200V	30typ (Io=100%) (At cold start) (Ta=25°C)					
LEAKAGE CURRENT[ma]	0.15/0.30max (ACIN 100V / 240V 60Hz, Io=100%, According to IEC60950-1 and DEN-AN)						
OUTPUT	VOLTAGE[V]	3.3	5	12	15	24	
	CURRENT[A]	3.0	3.0	1.3	1.0	0.7	
	LINE REGULATION[mV]	*5 20max	20max	48max	60max	96max	
	LOAD REGULATION[mV]	*5 40max	40max	100max	120max	150max	
	RIPPLE[mVp-p]	0 to +50°C	80max	80max	120max	120max	120max
		-10 - 0°C	140max	140max	160max	160max	160max
		Io=0 - 35%	190max	160max	240max	240max	280max
	RIPPLE NOISE[mVp-p]	0 to +50°C	120max	120max	150max	150max	150max
		-10 - 0°C	160max	160max	180max	180max	180max
		Io=0 - 35%	240max	240max	300max	300max	320max
	TEMPERATURE REGULATION[mV]	0 to +50°C	50max	50max	120max	150max	240max
		-10 to +50°C	60max	60max	150max	180max	290max
	DRIFT[mV]	*2 20max	20max	48max	60max	96max	
	START-UP TIME[ms]	200typ (ACIN 100V, Io=100%) * Start-up time is 700ms typ for less than 1 minute of applying input again from turning off the input voltage.					
HOLD-UP TIME[ms]	20typ (ACIN 100V, Io=100%)						
OUTPUT VOLTAGE ADJUSTMENT RANGE[V]	2.85 to 3.63	Fixed ("Y"option is available for adjusting output voltage between ±10%)					
OUTPUT VOLTAGE SETTING[V]	3.30 to 3.40	4.90 to 5.30	11.50 to 12.50	14.40 to 15.60	23.00 to 25.00		
PROTECTION CIRCUIT AND OTHERS	OVERCURRENT PROTECTION	Works over 105% of rating and recovers automatically					
	OVERVOLTAGE PROTECTION	4.00 to 5.25	5.75 to 7.00	13.80 to 16.80	17.25 to 21.00	27.60 to 33.60	
	OPERATING INDICATION	Not provided					
	REMOTE SENSING	Not provided					
ISOLATION	REMOTE ON/OFF	Not provided					
	INPUT-OUTPUT	AC3,000V 1minute, Cutoff current = 10mA, DC500V 50MΩ min (At Room Temperature)					
	INPUT-FG	AC2,000V 1minute, Cutoff current = 10mA, DC500V 50MΩ min (At Room Temperature)					
ENVIRONMENT	OUTPUT-FG	AC500V 1minute, Cutoff current = 25mA, DC500V 50MΩ min (At Room Temperature)					
	OPERATING TEMP., HUMID. AND ALTITUDE	-10 to +70°C, 20 - 90%RH (Non condensing) (Refer to Instruction Manual 3.2), 3,000m (10,000 feet) max *3					
	STORAGE TEMP., HUMID. AND ALTITUDE	-20 to +75°C, 20 - 90%RH (Non condensing), 9,000m (30,000 feet) max					
	VIBRATION	10 - 55Hz, 19.6m/s <sup>2</sup> (2G), 3minutes period, 60minutes each along X, Y and Z axis					
SAFETY AND NOISE REGULATIONS	IMPACT	196.1m/s <sup>2</sup> (20G), 11ms, once each X, Y and Z axis					
	AGENCY APPROVALS	UL60950-1, C-UL (CSA60950-1), EN60950-1, EN60065, EN50178 Complies with DEN-AN					
	CONDUCTED NOISE	Complies with FCC-B, VCCI-B, CISPR-B, EN55011-B, EN55022-B					
	HARMONIC ATTENUATOR	Complies with IEC61000-3-2 (Class A) *6 (Not built-in to active filter) *4					
OTHERS	CASE SIZE/WEIGHT	50×22×87.5mm [1.97×0.87×3.44 inches] (W×H×D) / 80g max (with chassis & cover : 190g max)					
	COOLING METHOD	Convection (Refer to Instruction Manual 3.1 and 3.2) *3					

\*1 This is the value that measured on measuring board with capacitor of 22 μF at 150mm from output terminal. Measured by 20MHz oscilloscope or Ripple-Noise meter (Equivalent to KEISOKU-GIKEN: RM103). A circuit reducing standby power is built in this unit. Therefore, the internal switch element is intermittent operated, and the Ripple/Ripple Noise specification in load

\*2 factor Io=0-35% is different. Please refer to the Instruction Manual 1.7.  
 \*3 Drift is the change in DC output for an eight hour period after a half-hour warm-up at 25°C, with the input voltage held constant at the rated input/output. Derating is required.  
 \*4 When two or more units are operating it may not comply with the IEC61000-3-2.

\*5 Please contact us for details.  
 \*6 Please contact us about dynamic load and input response.  
 \*7 Please contact us about another class.  
 \*8 To meet the specifications. Do not operate over-loaded condition. Parallel operation is not possible.  
 \*9 Derating is required when operated with chassis and cover.  
 \*10 Sound noise may be generated by power supply in case of pulse load.

## Block diagram



## External view



- ※ The back side of P.C.B. of the power supply is assembled some SMDs.  
Be attention not to bump against the attached area by vibration.
- ※ Use the spacer of 8mm length or more regarding insulation.  
And do not use press-fitting bush.
- ※ Point A, Point B are thermometry points. Please refer to Instruction Manual 3.

I/O Connector	Mating connector	Terminal	Terminal
CN1	1-1123724-3	1-1123722-5	Chain 1123721-1
			Loose 1318912-1
CN2	1-1123723-2	1-1123722-2	Chain 1123721-1
			Loose 1318912-1

(Mfr:Tyco Electronics)

- ※ I/O Connector is Mfr. Tyco Electronics
- ※ Option:-J1:(J.S.T) connector type. Refer to Instruction Manual 5.

### <PIN CONNECTION>

#### CN1

Pin No.	Input
1	AC(L)
2	
3	AC(N)
4	
5	FG

#### CN2

Pin No.	Output
1	-V
2	+V

- ※ Tolerance : ±1 [±0.04]
- ※ Weight : 80g max (with chassis & cover : 190g max)
- ※ PCB material / thickness : CEM3 / 1.6mm
- ※ Optional chassis and cover material : Electric galvanizing steel board.
- ※ Dimensions in mm, [ ]=inches
- ※ Mounting torque (Mounting hole of chassis) : 0.6N · m (6.3kgf · cm) max

# LFA30F

① LF ② A ③ 30 ④ F ⑤ -□ ⑥ -□



Recommended EMI/EMC Filter  
NAC-04-472



High voltage pulse noise type : NAP series  
Low leakage current type : NAM series  
\*The EMI/EMC Filter is recommended to connect with several devices.

- ① Series name
- ② Single output
- ③ Output wattage
- ④ Universal input
- ⑤ Output voltage
- ⑥ Optional
- C : with Coating
- G : Low leakage current
- J1 : VH(J.S.T.)connector type
- S : with Chassis
- SN : with Chassis & cover
- Y : with Potentiometer

Specification is changed at option, refer to Instruction Manual.

This power supply is manufactured by SMD technology. The stress to P.C.B like twisting or bending causes the defect of the unit, so handle the unit with care.

MODEL	LFA30F-3R3-Y	LFA30F-5	LFA30F-12	LFA30F-15	LFA30F-24
MAX OUTPUT WATTAGE[W]	19.8	30.0	30.0	30.0	31.2
DC OUTPUT	3.3V 6A	5V 6A	12V 2.5A	15V 2A	24V 1.3A

## SPECIFICATIONS

	MODEL	LFA30F-3R3-Y	LFA30F-5	LFA30F-12	LFA30F-15	LFA30F-24	
INPUT	VOLTAGE[V]	AC85 - 264 1φ (Refer to Instruction Manual 1.1 and 3.2) *3					
	CURRENT[A]	ACIN 100V	0.50typ (Io=100%)	0.65typ (Io=100%)			
		ACIN 200V	0.30typ (Io=100%)	0.35typ (Io=100%)			
	FREQUENCY[Hz]	50 / 60 (47 - 440)					
	EFFICIENCY[%]	ACIN 100V	73typ	76typ	79typ	81typ	82typ
		ACIN 200V	75typ	79typ	81typ	83typ	84typ
INRUSH CURRENT[A]	ACIN 100V	15typ (Io=100%) (At cold start) (Ta=25°C)					
	ACIN 200V	30typ (Io=100%) (At cold start) (Ta=25°C)					
LEAKAGE CURRENT[mA]	0.30 / 0.65max (ACIN 100V / 240V 60Hz, Io=100%, According to IEC60950-1 and DEN-AN)						
OUTPUT	VOLTAGE[V]	3.3	5	12	15	24	
	CURRENT[A]	6.0	6.0	2.5	2.0	1.3	
	LINE REGULATION[mV] *5	20max	20max	48max	60max	96max	
	LOAD REGULATION[mV] *5	40max	40max	100max	120max	150max	
	RIPPLE[mVp-p]	0 to +50°C *1	80max	80max	120max	120max	120max
		-10 - 0°C *1	140max	140max	160max	160max	160max
	RIPPLE NOISE[mVp-p]	0 to +50°C *1	120max	120max	150max	150max	150max
		-10 - 0°C *1	160max	160max	180max	180max	180max
	TEMPERATURE REGULATION[mV]	0 to +50°C	50max	50max	120max	150max	240max
		-10 to +50°C	60max	60max	150max	180max	290max
	DRIFT[mV] *2	20max	20max	48max	60max	96max	
	START-UP TIME[ms]	150typ (ACIN 100V, Io=100%)					
	HOLD-UP TIME[ms]	20typ (ACIN 100V, Io=100%)					
OUTPUT VOLTAGE ADJUSTMENT RANGE[V]	2.85 to 3.63	Fixed ("Y"option is available for adjusting output voltage between ±10%)					
OUTPUT VOLTAGE SETTING[V]	3.30 to 3.40	4.90 to 5.30	11.50 to 12.50	14.40 to 15.60	23.00 to 25.00		
PROTECTION CIRCUIT AND OTHERS	OVERCURRENT PROTECTION	Works over 105% of rating and recovers automatically					
	OVERVOLTAGE PROTECTION	4.00 to 5.25	5.75 to 7.00	13.80 to 16.80	17.25 to 21.00	27.60 to 33.60	
	OPERATING INDICATION	Not provided					
	REMOTE SENSING	Not provided					
	REMOTE ON/OFF	Not provided					
ISOLATION	INPUT-OUTPUT	AC3,000V 1minute, Cutoff current = 10mA, DC500V 50MΩ min (At Room Temperature)					
	INPUT-FG	AC2,000V 1minute, Cutoff current = 10mA, DC500V 50MΩ min (At Room Temperature)					
	OUTPUT-FG	AC500V 1minute, Cutoff current = 25mA, DC500V 50MΩ min (At Room Temperature)					
ENVIRONMENT	OPERATING TEMP, HUMID. AND ALTITUDE	-10 to +70°C, 20 - 90%RH (Non condensing) (Refer to Instruction Manual 3.2), 3,000m (10,000feet) max *3					
	STORAGE TEMP, HUMID. AND ALTITUDE	-20 to +75°C, 20 - 90%RH (Non condensing), 9,000m (30,000feet) max					
	VIBRATION	10 - 55Hz, 19.6m/s <sup>2</sup> (2G), 3minutes period, 60minutes each along X, Y and Z axis					
	IMPACT	196.1m/s <sup>2</sup> (20G), 11ms, once each X, Y and Z axis					
SAFETY AND NOISE REGULATIONS	AGENCY APPROVALS	UL60950-1, C-UL (CSA60950-1), EN60950-1, EN60065, EN50178 Complies with DEN-AN					
	CONDUCTED NOISE	Complies with FCC-B, VCCI-B, CISPR-B, EN55011-B, EN55022-B					
	HARMONIC ATTENUATOR	Complies with IEC61000-3-2 (Class A) *6 (Not built-in to active filter) *4					
OTHERS	CASE SIZE/WEIGHT	50 X 26.5 X 105mm [1.97 X 1.04 X 4.13 inches] (W X H X D) / 130g max (with chassis & cover : 260g max)					
	COOLING METHOD	Convection (Refer to Instruction Manual 3.1 and 3.2) *3					

\*1 This is the value that measured on measuring board with capacitor of 22 μF at 150mm from output terminal.  
Measured by 20MHz oscilloscope or Ripple-Noise meter (Equivalent to KEISOKU-GIKEN: RM103).  
\*2 Drift is the change in DC output for an eight hour period after a half-hour warm-up at 25°C, with the input voltage held constant at the rated input/output.  
\*3 Derating is required.

\*4 When two or more units are operating it may not comply with the IEC61000-3-2. Please contact us for details.  
\*5 Please contact us about dynamic load and input response.  
\*6 Please contact us about another class.  
\* To meet the specifications. Do not operate over-loaded condition.  
\* Parallel operation is not possible.  
\* Derating is required when operated with chassis and cover.  
\* Sound noise may be generated by power supply in case of pulse load.



## Block diagram



## External view



- ※ 4 Mounting holes are existing.
- ※ The back side of P.C.B. of the power supply is assembled some SMDs.
- Be attention not to bump against the attached area by vibration.
- ※ Use the spacer of 8mm length or more regarding insulation.
- And do not use press-fitting bush.
- ※ Point A, Point B are thermometry points. Please refer to Instruction Manual 3.

I/O Connector	Mating connector	Terminal
CN1	1-1123724-3	Chain 1123721-1
		Loose 1318912-1
CN2	1-1123723-4	Chain 1123721-1
		Loose 1318912-1

(Mfr: Tyco Electronics)

- ※ I/O Connector is Mfr. Tyco Electronics
- ※ Option: -J1:(J.S.T) connector type. Refer to Instruction Manual 5.

### <PIN CONNECTION>

CN1		CN2	
Pin No.	Input	Pin No.	Output
1	AC(L)	1, 2	-V
2			
3	AC(N)	3, 4	+V
4			
5	FG		

- ※ Tolerance :  $\pm 1$  [±0.04]
- ※ Weight: 130g max (with chassis & cover : 260g max)
- ※ PCB material / thickness : CEM3 / 1.6mm
- ※ Optional chassis and cover material : Electric galvanizing steel board.
- ※ Dimensions in mm, [ ] =inches
- ※ Mounting torque (Mounting hole of chassis) : 0.6N · m (6.3kgf · cm) max

※ Keep drawing current per pin below 5A for CN2.

# LFA50F

LF A 50 F -□ -□  
 ① ② ③ ④ ⑤ ⑥



Recommended EMI/EMC Filter  
**NAC-04-472**



High voltage pulse noise type : NAP series  
 Low leakage current type : NAM series  
 \*The EMI/EMC Filter is recommended to connect with several devices.

- ① Series name
- ② Single output
- ③ Output wattage
- ④ Universal input
- ⑤ Output voltage
- ⑥ Optional
- C : with Coating
- G : Low leakage current
- J1 : VH(J.S.T.)connector type
- S : with Chassis
- SN: with Chassis & cover
- Y : with Potentiometer

Specification is changed at option, refer to Instruction Manual.

This power supply is manufactured by SMD technology. The stress to P.C.B like twisting or bending causes the defect of the unit, so handle the unit with care.

MODEL	LFA50F-3R3-Y	LFA50F-5	LFA50F-12	LFA50F-15	LFA50F-24	LFA50F-36	LFA50F-48
MAX OUTPUT WATTAGE[W]	33	50	51.6	52.5	50.4	50.4	52.8
DC OUTPUT	3.3V 10A	5V 10A	12V 4.3A	15V 3.5A	24V 2.1A	36V 1.4A	48V 1.1A

## SPECIFICATIONS

	MODEL	LFA50F-3R3-Y	LFA50F-5	LFA50F-12	LFA50F-15	LFA50F-24	LFA50F-36	LFA50F-48	
INPUT	VOLTAGE[V]	AC85 - 264 1 φ (Refer to Instruction Manual 1.1 and 3.2) *3							
	CURRENT[A]	ACIN 100V	0.47typ (Io=100%)		0.67typ (Io=100%)				
		ACIN 200V	0.27typ (Io=100%)		0.36typ (Io=100%)				
	FREQUENCY[Hz]	50 / 60 (47 - 63)							
	EFFICIENCY[%]	ACIN 100V	73.5typ	77.5typ	80.0typ	80.5typ	81.5typ	82.0typ	81.0typ
		ACIN 200V	74.0typ	79.0typ	81.5typ	81.5typ	83.0typ	83.5typ	82.5typ
	POWER FACTOR (Io=100%)	ACIN 100V	0.96typ	0.97typ					
ACIN 200V		0.83typ	0.90typ						
INRUSH CURRENT[A]	ACIN 100V	15typ (Io=100%) (At cold start) (Ta=25°C)							
	ACIN 200V	30typ (Io=100%) (At cold start) (Ta=25°C)							
LEAKAGE CURRENT[mA]	0.40 / 0.75max (ACIN 100V / 240V 60Hz, Io=100%, According to IEC60950-1 and DEN-AN)								
OUTPUT	VOLTAGE[V]	3.3	5	12	15	24	36	48	
	CURRENT[A]	10.0	10.0	4.3	3.5	2.1	1.4	1.1	
	LINE REGULATION[mV] *4	20max	20max	48max	60max	96max	144max	192max	
	LOAD REGULATION[mV] *4	40max	40max	100max	120max	150max	240max	240max	
	RIPPLE[mVp-p]	0 to +50°C *1	80max	80max	120max	120max	150max	150max	150max
		-10 -0°C *1	140max	140max	160max	160max	160max	200max	200max
	RIPPLE NOISE[mVp-p]	0 to +50°C *1	120max	120max	150max	150max	150max	250max	250max
		-10 -0°C *1	160max	160max	180max	180max	180max	300max	300max
	TEMPERATURE REGULATION[mV]	0 to +50°C	50max	50max	120max	150max	240max	360max	480max
		-10 to +50°C	60max	60max	150max	180max	290max	450max	600max
	DRIFT[mV] *2	20max	20max	48max	60max	96max	144max	192max	
	START-UP TIME[ms]	350typ (ACIN 100V, Io=100%)							
HOLD-UP TIME[ms]	20typ (ACIN 100V, Io=100%)								
OUTPUT VOLTAGE ADJUSTMENT RANGE[V]	2.85 to 3.63	Fixed ("Y"option is available for adjusting output voltage between ±10%)							
OUTPUT VOLTAGE SETTING[V]	3.30 to 3.40	4.90 to 5.30	11.50 to 12.50	14.40 to 15.60	23.00 to 25.00	34.50 to 37.50	46.00 to 50.00		
PROTECTION CIRCUIT AND OTHERS	OVERCURRENT PROTECTION	Works over 105% of rating and recovers automatically							
	OVERVOLTAGE PROTECTION	4.00 to 5.25	5.75 to 7.00	13.80 to 16.80	17.25 to 21.00	27.60 to 33.60	41.40 to 50.40	55.20 to 67.20	
	OPERATING INDICATION	Not provided							
	REMOTE SENSING	Not provided							
	REMOTE ON/OFF	Not provided							
ISOLATION	INPUT-OUTPUT	AC3,000V 1minute, Cutoff current = 10mA, DC500V 50MΩ min (At Room Temperature)							
	INPUT-FG	AC2,000V 1minute, Cutoff current = 10mA, DC500V 50MΩ min (At Room Temperature)							
	OUTPUT-FG	AC500V 1minute, Cutoff current = 25mA, DC500V 50MΩ min (At Room Temperature)							
ENVIRONMENT	OPERATING TEMP., HUMID. AND ALTITUDE	-10 to +70°C, 20 - 90%RH (Non condensing) (Refer to Instruction Manual 3.2), 3,000m (10,000feet) max *3							
	STORAGE TEMP., HUMID. AND ALTITUDE	-20 to +75°C, 20 - 90%RH (Non condensing), 9,000m (30,000feet) max							
	VIBRATION	10 - 55Hz, 19.6m/s <sup>2</sup> (2G), 3minutes period, 60minutes each along X, Y and Z axis							
	IMPACT	196.1m/s <sup>2</sup> (20G), 11ms, once each X, Y and Z axis							
SAFETY AND NOISE REGULATIONS	AGENCY APPROVALS	UL60950-1, C-UL (CSA60950-1), EN60950-1, EN60065, EN50178 Complies with DEN-AN							
	CONDUCTED NOISE	Complies with FCC-B, VCCI-B, CISPR-B, EN55011-B, EN55022-B							
	HARMONIC ATTENUATOR	Complies with IEC61000-3-2 (Class A) *5							
OTHERS	CASE SIZE/WEIGHT	50 X 26.5 X 132mm [1.97 X 1.04 X 5.20 inches] (W X H X D) / 165g max (with chassis & cover : 325g max)							
	COOLING METHOD	Convection (Refer to Instruction Manual 3.1 and 3.2) *3							

\*1 This is the value that measured on measuring board with capacitor of 22 μF at 150mm from output terminal.  
 Measured by 20MHz oscilloscope or Ripple-Noise meter (Equivalent to KEISOKU-GIKEN: RM103).

\*2 Drift is the change in DC output for an eight hour period after a half-hour warm-up at 25°C, with the input voltage held constant at the rated input/output.

\*3 Derating is required.

\*4 Please contact us about dynamic load and input response.

\*5 Please contact us about another class.

\* To meet the specifications. Do not operate over-loaded condition.

\* Parallel operation is not possible.

\* Derating is required when operated with chassis and cover.

\* Sound noise may be generated by power supply in case of pulse load.

## Block diagram



## External view

Standard type

Chassis and cover type



- ※ 4 Mounting holes are existing.
- ※ The back side of P.C.B. of the power supply is assembled some SMDs.  
Be attention not to bump against the attached area by vibration.
- ※ Use the spacer of 8mm length or more regarding insulation.  
And do not use press-fitting bush.
- ※ Point A, Point B are thermometry points. Please refer to Instruction Manual 3.

I/O Connector	Mating connector	Terminal
CN1	1-1123724-3	Chain 1123721-1
		Loose 1318912-1
CN2	1-1123724-4	Chain 1123721-1
		Loose 1318912-1

(Mfr:Tyco Electronics)

- ※ I/O Connector is Mfr. Tyco Electronics
- ※ Option-J1:(J.S.T) connector type. Refer to Instruction Manual 5.

### <PIN CONNECTION>

CN1

Pin No.	Input
1	AC(L)
2	
3	AC(N)
4	
5	FG

CN2

Pin No.	Output
1, 2	-V
3, 4	+V

- ※ Tolerance :  $\pm 1$  [ $\pm 0.04$ ]
- ※ Weight : 165g max (with chassis & cover : 325g max)
- ※ PCB material / thickness : CEM3 / 1.6mm
- ※ Optional chassis and cover material : Electric galvanizing steel board.
- ※ Dimensions in mm, [ ]=inches
- ※ Mounting torque (Mounting hole of chassis) : 0.6N · m (6.3kgf · cm) max

- ※ Keep drawing current per pin below 5A for CN2.



# LFA75F

① LF ② A ③ 75 ④ F ⑤ -□ ⑥ -□



Recommended EMI/EMC Filter  
NAC-04-472



High voltage pulse noise type : NAP series  
Low leakage current type : NAM series  
\*The EMI/EMC Filter is recommended to connect with several devices.

- ① Series name
- ② Single output
- ③ Output wattage
- ④ Universal input
- ⑤ Output voltage
- ⑥ Optional
- C : with Coating
- G : Low leakage current
- J1 : VH(J.S.T.)connector type
- S : with Chassis
- SN: with Chassis & cover
- Y : with Potentiometer

Specification is changed at option, refer to Instruction Manual.

This power supply is manufactured by SMD technology. The stress to P.C.B like twisting or bending causes the defect of the unit, so handle the unit with care.

MODEL	LFA75F-3R3-Y	LFA75F-5	LFA75F-12	LFA75F-15	LFA75F-24	LFA75F-36	LFA75F-48
MAX OUTPUT WATTAGE[W]	49.5	75	75.6	75	76.8	75.6	76.8
DC OUTPUT	3.3V 15A	5V 15A	12V 6.3A	15V 5A	24V 3.2A	36V 2.1A	48V 1.6A

## SPECIFICATIONS

	MODEL	LFA75F-3R3-Y	LFA75F-5	LFA75F-12	LFA75F-15	LFA75F-24	LFA75F-36	LFA75F-48	
INPUT	VOLTAGE[V]	AC85 - 264 1 φ (Refer to Instruction Manual 1.1 and 3.2) *3							
	CURRENT[A]	ACIN 100V	0.70typ (Io=100%)		1.00typ (Io=100%)				
		ACIN 200V	0.40typ (Io=100%)		0.50typ (Io=100%)				
	FREQUENCY[Hz]	50 / 60 (47 - 63)							
	EFFICIENCY[%]	ACIN 100V	73.5typ	78.0typ	81.5typ	81.5typ	82.5typ	82.5typ	82.5typ
		ACIN 200V	75.0typ	80.0typ	83.0typ	83.0typ	84.5typ	84.5typ	84.5typ
	POWER FACTOR (Io=100%)	ACIN 100V	0.96typ	0.97typ					
ACIN 200V		0.83typ	0.90typ						
INRUSH CURRENT[A]	ACIN 100V	15typ (Io=100%) (At cold start) (Ta=25°C)							
	ACIN 200V	30typ (Io=100%) (At cold start) (Ta=25°C)							
LEAKAGE CURRENT[mA]	0.40 / 0.75max (ACIN 100V / 240V 60Hz, Io=100%, According to IEC60950-1 and DEN-AN)								
OUTPUT	VOLTAGE[V]	3.3	5	12	15	24	36	48	
	CURRENT[A]	15.0	15.0	6.3	5.0	3.2	2.1	1.6	
	LINE REGULATION[mV] *4	20max	20max	48max	60max	96max	144max	192max	
	LOAD REGULATION[mV] *4	40max	40max	100max	120max	150max	240max	240max	
	RIPPLE[mVp-p]	0 to +50°C *1	80max	80max	120max	120max	120max	150max	150max
		-10 -0°C *1	140max	140max	160max	160max	160max	200max	200max
	RIPPLE NOISE[mVp-p]	0 to +50°C *1	120max	120max	150max	150max	150max	250max	250max
		-10 -0°C *1	160max	160max	180max	180max	180max	300max	300max
	TEMPERATURE REGULATION[mV]	0 to +50°C	50max	50max	120max	150max	240max	360max	480max
		-10 to +50°C	60max	60max	150max	180max	290max	450max	600max
	DRIFT[mV] *2	20max	20max	48max	60max	96max	144max	192max	
	START-UP TIME[ms]	350typ (ACIN 100V, Io=100%)							
	HOLD-UP TIME[ms]	20typ (ACIN 100V, Io=100%)							
OUTPUT VOLTAGE ADJUSTMENT RANGE[V]	2.85 to 3.63	Fixed ("Y"option is available for adjusting output voltage between ±10%)							
OUTPUT VOLTAGE SETTING[V]	3.30 to 3.40	4.90 to 5.30	11.50 to 12.50	14.40 to 15.60	23.00 to 25.00	34.50 to 37.50	46.00 to 50.00		
PROTECTION CIRCUIT AND OTHERS	OVERCURRENT PROTECTION	Works over 105% of rating and recovers automatically							
	OVERVOLTAGE PROTECTION	4.00 to 5.25	5.75 to 7.00	13.80 to 16.80	17.25 to 21.00	27.60 to 33.60	41.40 to 50.40	55.20 to 67.20	
	OPERATING INDICATION	Not provided							
	REMOTE SENSING	Not provided							
	REMOTE ON/OFF	Not provided							
ISOLATION	INPUT-OUTPUT	AC3,000V 1minute, Cutoff current = 10mA, DC500V 50MΩ min (At Room Temperature)							
	INPUT-FG	AC2,000V 1minute, Cutoff current = 10mA, DC500V 50MΩ min (At Room Temperature)							
	OUTPUT-FG	AC500V 1minute, Cutoff current = 25mA, DC500V 50MΩ min (At Room Temperature)							
ENVIRONMENT	OPERATING TEMP., HUMID. AND ALTITUDE	-10 to +70°C, 20 - 90%RH (Non condensing) (Refer to Instruction Manual 3.2), 3,000m (10,000feet) max *3							
	STORAGE TEMP., HUMID. AND ALTITUDE	-20 to +75°C, 20 - 90%RH (Non condensing), 9,000m (30,000feet) max							
	VIBRATION	10 - 55Hz, 19.6m/s <sup>2</sup> (2G), 3minutes period, 60minutes each along X, Y and Z axis							
	IMPACT	196.1m/s <sup>2</sup> (20G), 11ms, once each X, Y and Z axis							
SAFETY AND NOISE REGULATIONS	AGENCY APPROVALS	UL60950-1, C-UL (CSA60950-1), EN60950-1, EN60065, EN50178 Complies with DEN-AN							
	CONDUCTED NOISE	Complies with FCC-B, VCCI-B, CISPR-B, EN55011-B, EN55022-B							
	HARMONIC ATTENUATOR	Complies with IEC61000-3-2 (Class A) *5							
OTHERS	CASE SIZE/WEIGHT	50 X 33.5 X 150mm [1.97 X 1.32 X 5.91 inches] (W X H X D) / 230g max (with chassis & cover : 440g max)							
	COOLING METHOD	Convection (Refer to Instruction Manual 3.1 and 3.2) *3							

\*1 This is the value that measured on measuring board with capacitor of 22 μF at 150mm from output terminal.  
Measured by 20MHz oscilloscope or Ripple-Noise meter (Equivalent to KEISOKU-GIKEN: RM103).

\*2 Drift is the change in DC output for an eight hour period after a half-hour warm-up at 25°C, with the input voltage held constant at the rated input/output.

\*3 Derating is required.

\*4 Please contact us about dynamic load and input response.

\*5 Please contact us about another class.

\* To meet the specifications. Do not operate over-loaded condition.

\* Parallel operation is not possible.

\* Derating is required when operated with chassis and cover.

\* Sound noise may be generated by power supply in case of pulse load.

## Block diagram



LFA

## External view

Standard type

Chassis and cover type



- ※ 4 Mounting holes are existing.
- ※ The back side of P.C.B. of the power supply is assembled some SMDs.  
Be attention not to bump against the attached area by vibration.
- ※ Use the spacer of 8mm length or more regarding insulation.  
And do not use press-fitting bush.
- ※ Point A, Point B are thermometry points. Please refer to Instruction Manual 3.

I/O Connector	Mating connector	Terminal
CN1	1-1123724-3	Chain 1123721-1
		Loose 1318912-1
CN2	1-1123723-6	Chain 1123721-1
		Loose 1318912-1

(Mfr:Tyco Electronics)

- ※ I/O Connector is Mfr. Tyco Electronics
- ※ Option:-J1:(J.S.T) connector type. Refer to Instruction Manual 5.

### <PIN CONNECTION>

#### CN1

Pin No.	Input
1	AC(L)
2	
3	AC(N)
4	
5	FG

#### CN2

Pin No.	Output
1 to 3	-V
4 to 6	+V

- ※ Tolerance :  $\pm 1$  [ $\pm 0.04$ ]
- ※ Weight : 230g max (with chassis & cover : 440g max)
- ※ PCB material / thickness : CEM3 / 1.6mm
- ※ Optional chassis and cover material : Electric galvanizing steel board.
- ※ Dimensions in mm, [ ]=inches
- ※ Mounting torque (Mounting hole of chassis) :  $1.5N \cdot m$  (16kgf  $\cdot$  cm) max

※ Keep drawing current per pin below 5A for CN2.

# LFA100F

① LF ② A ③ 100 ④ F ⑤ -□ ⑥ -□

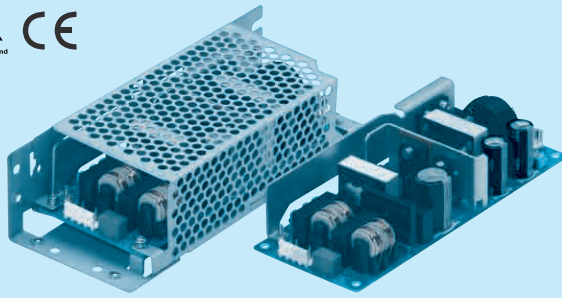

Recommended EMI/EMC Filter  
NAC-04-472



High voltage pulse noise type : NAP series  
Low leakage current type : NAM series  
\*The EMI/EMC Filter is recommended to connect with several devices.

- ① Series name
  - ② Single output
  - ③ Output wattage
  - ④ Universal input
  - ⑤ Output voltage
  - ⑥ Optional \*1
  - C : with Coating
  - G : Low leakage current
  - H : with the function to be acceptable to output peak current (only 24V)
  - J1 : VH(J.S.T.)connector type
  - R : with Remote ON/OFF
  - R2 : with Remote ON/OFF
  - S : with Chassis
  - SN : with Chassis & cover
  - Y : with Potentiometer
- Please refer to Instruction manual 5.

This power supply is manufactured by SMD technology. The stress to P.C.B like twisting or bending causes the defect of the unit, so handle the unit with care.

MODEL	LFA100F-3R3-Y	LFA100F-5-Y	LFA100F-12	LFA100F-15	LFA100F-24	LFA100F-24-H	LFA100F-36	LFA100F-48
MAX OUTPUT WATTAGE[W]	*5 66	100	102	100.5	103.2	103.2 (129.6)	100.8	100.8
DC OUTPUT	*5 3.3V 20A	5V 20A	12V 8.5A	15V 6.7A	24V 4.3A	24V 4.3 (5.4)A	36V 2.8A	48V 2.1A

## SPECIFICATIONS

	MODEL	LFA100F-3R3-Y	LFA100F-5-Y	LFA100F-12	LFA100F-15	LFA100F-24	LFA100F-24-H	LFA100F-36	LFA100F-48	
INPUT	VOLTAGE[V]	AC85 - 264 1 φ (Refer to Instruction Manual 1.1 and 3.2) *4								
	CURRENT[A]	ACIN 100V	0.9typ (Io=100%)	1.3typ (Io=100%)						
		ACIN 200V	0.5typ (Io=100%)	0.7typ (Io=100%)						
	FREQUENCY[Hz]	50 / 60 (47 - 63)								
	EFFICIENCY[%]	ACIN 100V	77.0typ	82.0typ	82.0typ	83.0typ	84.0typ	84.0typ	84.0typ	84.5typ
		ACIN 200V	79.0typ	84.0typ	84.5typ	85.5typ	87.0typ	87.0typ	87.0typ	87.0typ
	POWER FACTOR (Io=100%)	ACIN 100V	0.98typ	0.99typ						
ACIN 200V		0.92typ	0.95typ							
INRUSH CURRENT[A]	ACIN 100V	15typ (Io=100%) (At cold start) (Ta=25°C)								
	ACIN 200V	30typ (Io=100%) (At cold start) (Ta=25°C)								
LEAKAGE CURRENT[mA]	0.40 / 0.75max (ACIN 100V / 240V 60Hz, Io=100%, According to IEC60950-1 and DEN-AN)									
OUTPUT	VOLTAGE[V]	3.3	5	12	15	24	24	36	48	
	CURRENT[A]	*5 20	20	8.5	6.7	4.3	4.3 (Peak 5.4)	2.8	2.1	
	LINE REGULATION[mV]	*7 20max	20max	48max	60max	96max	96max	144max	192max	
	LOAD REGULATION[mV]	*7 40max	40max	100max	120max	150max	150max	240max	240max	
	RIPPLE[mVp-p]	0 to +50°C *2	80max	80max	120max	120max	120max	240max	150max	150max
		-10 -0°C *2	140max	140max	160max	160max	160max	320max	200max	200max
	RIPPLE NOISE[mVp-p]	0 to +50°C *2	120max	120max	150max	150max	150max	300max	250max	250max
		-10 -0°C *2	160max	160max	180max	180max	180max	360max	300max	300max
	TEMPERATURE REGULATION[mV]	0 to +50°C	50max	50max	120max	150max	240max	240max	360max	480max
		-10 to +50°C	60max	60max	150max	180max	290max	290max	450max	600max
	DRIFT[mV]	*3 20max	20max	48max	60max	96max	96max	144max	192max	
	START-UP TIME[ms]	350typ (ACIN 100V, Io=100%)								
	HOLD-UP TIME[ms]	20typ (ACIN 100V, Io=100%)								
OUTPUT VOLTAGE ADJUSTMENT RANGE[V]	2.85 to 3.63		4.50 to 5.50		Fixed ("Y"option is available for adjusting output voltage)					
OUTPUT VOLTAGE SETTING[V]	3.30 to 3.40	5.00 to 5.15	11.50 to 12.50	14.40 to 15.60	23.00 to 25.00	23.00 to 25.00	34.50 to 37.50	46.00 to 50.00		
PROTECTION CIRCUIT AND OTHERS	OVERCURRENT PROTECTION	Works over 105% of rating (works over 101% of peak current at option -H) and recovers automatically								
	OVERVOLTAGE PROTECTION	4.00 to 5.25	5.75 to 7.00	13.80 to 16.80	17.25 to 21.00	27.60 to 33.60	27.60 to 33.60	41.40 to 50.40	55.20 to 67.20	
	OPERATING INDICATION	Not provided								
	REMOTE SENSING	Not provided								
	REMOTE ON/OFF	Option (Refer to Instruction Manual)								
ISOLATION	INPUT-OUTPUT-RC	*6 AC3,000V 1minute, Cutoff current = 10mA, DC500V 50MΩ min (At Room Temperature)								
	INPUT-FG	AC2,000V 1minute, Cutoff current = 10mA, DC500V 50MΩ min (At Room Temperature)								
	OUTPUT-RC-FG	*6 AC500V 1minute, Cutoff current = 25mA, DC500V 50MΩ min (At Room Temperature)								
	OUTPUT-RC	*6 AC100V 1minute, Cutoff current = 25mA, DC100V 10MΩ min (At Room Temperature)								
ENVIRONMENT	OPERATING TEMP., HUMID. AND ALTITUDE *4	-10 to +70°C, 20 - 90%RH (Non condensing) (Refer to Instruction Manual 3.2), 3,000m (10,000feet) max								
	STORAGE TEMP., HUMID. AND ALTITUDE	-20 to +75°C, 20 - 90%RH (Non condensing), 9,000m (30,000feet) max								
	VIBRATION	10 - 55Hz, 19.6m/s <sup>2</sup> (2G), 3minutes period, 60minutes each along X, Y and Z axis								
	IMPACT	196.1m/s <sup>2</sup> (20G), 11ms, once each X, Y and Z axis								
SAFETY AND NOISE REGULATIONS	AGENCY APPROVALS	UL60950-1, C-UL (CSA60950-1), EN60950-1, EN60065, EN50178 Complies with DEN-AN								
	CONDUCTED NOISE	Complies with FCC-B, VCCI-B, CISPR-B, EN55011-B, EN55022-B								
	HARMONIC ATTENUATOR	Complies with IEC61000-3-2 (Class A) *8								
OTHERS	CASE SIZE/WEIGHT	62 X 33.5 X 155mm [2.44 X 1.32 X 6.10 inches] (W X H X D) / 280g max (with chassis & cover : 480g max)								
	COOLING METHOD	Convection (Refer to Instruction Manual 3.1 and 3.2) *4								

\*1 Specification is changed at option, refer to Instruction Manual.  
 \*2 This is the value that measured on measuring board with capacitor of 22μF at 150mm from output terminal.  
 \*3 Drift is the change in DC output for an eight hour period after a half-hour warm-up at 25°C, with the input voltage held constant  
 \*4 at the rated input/output.  
 \*5 Derating is required.  
 \*6 Applicable when Remote ON/OFF (optional) is added.  
 \*7 Please contact us about dynamic load and input response.  
 \*8 Please contact us about another class.  
 \*9 To meet the specifications. Do not operate over-loaded condition.  
 \*10 Parallel operation is not possible.  
 \*11 Derating is required when operated with chassis and cover.  
 \*12 Sound noise may be generated by power supply in case of pulse load.

## Block diagram



## External view

※ External size of option is different from standard model.

Standard type



Chassis and cover type



- ※ 4 Mounting holes are existing.
- ※ The back side of P.C.B. of the power supply is assembled some SMDs.  
Be attention not to bump against the attached area by vibration.
- ※ Use the spacer of 8mm length or more regarding insulation.  
And do not use press-fitting bush.
- ※ Point A, Point B are thermometry points. Please refer to Instruction Manual 3.

I/O Connector	Mating connector	Terminal	
CN1	1-1123724-3	Chain	1123721-1
		Loose	1318912-1
CN2	1-1123723-8	Chain	1123721-1
		Loose	1318912-1

(Mfr:Tyco Electronics)

- ※ I/O Connector is Mfr. Tyco Electronics
- ※ Option:-J1:VH(J.S.T) connector type.

### <PIN CONNECTION>

#### CN1

Pin No.	Input
1	AC(L)
2	
3	AC(N)
4	
5	FG

#### CN2

Pin No.	Output
1 to 4	-V
5 to 8	+V

※ Keep drawing current per pin below 5A for CN2.

- ※ Tolerance :  $\pm 1$  [ $\pm 0.04$ ]
- ※ Weight : 280g max (with chassis & cover : 480g max)
- ※ PCB material : CEM3
- ※ Optional chassis and cover material : Electric galvanizing steel board.
- ※ Dimensions in mm, [ ]=inches
- ※ Mounting torque (Mounting hole of chassis) :1.5N · m (16kgf · cm) max

### Connector type

#### CN4 Option (Mfr.J.S.T)

PIN No.	Contents
1	RC(+)
2	RC(-)

### Barrier strip type

Model B2B-XH-A  
Mating Connector (Terminal)  
XHP-2  
( BXH-001T-P0.6  
or SXH-001T-P0.6 )

# LFA150F

① LF ② A ③ 150 ④ F ⑤ -□ ⑥ -□

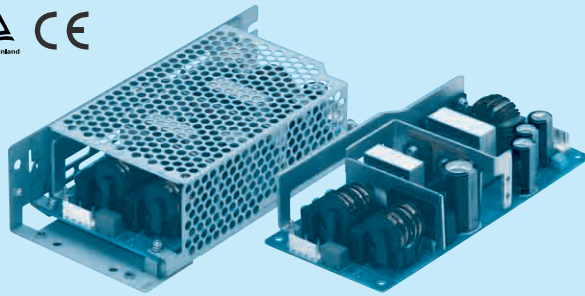

Recommended EMI/EMC Filter  
NAC-04-472



High voltage pulse noise type : NAP series  
Low leakage current type : NAM series  
\*The EMI/EMC Filter is recommended to connect with several devices.

- ① Series name
  - ② Single output
  - ③ Output wattage
  - ④ Universal input
  - ⑤ Output voltage
  - ⑥ Optional \*1
  - C : with Coating
  - G : Low leakage current
  - H : with the function to be acceptable to output peak current (only 24V)
  - J1 : VH(J.S.T.)connector type
  - R : with Remote ON/OFF
  - R2 : with Remote ON/OFF
  - S : with Chassis
  - SN : with Chassis & cover
  - Y : with Potentiometer
- Please refer to Instruction manual 5.

This power supply is manufactured by SMD technology. The stress to P.C.B like twisting or bending causes the defect of the unit, so handle the unit with care.

MODEL	LFA150F-3R3-Y	LFA150F-5-Y	LFA150F-12	LFA150F-15	LFA150F-24	LFA150F-24-H	LFA150F-36	LFA150F-48
MAX OUTPUT WATTAGE[W]	99	150	150	150	151.2	151.2 (189.6)	151.2	153.6
DC OUTPUT	3.3V 30A	5V 30A	12V 12.5A	15V 10A	24V 6.3A	24V 6.3 (7.9)A	36V 4.2A	48V 3.2A

## SPECIFICATIONS

	MODEL	LFA150F-3R3-Y	LFA150F-5-Y	LFA150F-12	LFA150F-15	LFA150F-24	LFA150F-24-H	LFA150F-36	LFA150F-48	
INPUT	VOLTAGE[V]	AC85 - 264 1 φ (Refer to Instruction Manual 1.1 and 3.2) *4								
	CURRENT[A]	ACIN 100V	1.4typ (Io=100%)	2.0typ (Io=100%)						
		ACIN 200V	0.7typ (Io=100%)	1.0typ (Io=100%)						
	FREQUENCY[Hz]	50 / 60 (47 - 63)								
	EFFICIENCY[%]	ACIN 100V	80.0typ	82.5typ	82.5typ	84.0typ	85.0typ	85.0typ	85.0typ	85.5typ
		ACIN 200V	82.0typ	85.5typ	85.0typ	86.5typ	87.5typ	87.5typ	87.5typ	88.0typ
	POWER FACTOR (Io=100%)	ACIN 100V	0.98typ	0.99typ						
ACIN 200V		0.92typ	0.95typ							
INRUSH CURRENT[A]	ACIN 100V	15typ (Io=100%) (At cold start) (Ta=25°C)								
	ACIN 200V	30typ (Io=100%) (At cold start) (Ta=25°C)								
LEAKAGE CURRENT[mA]	0.40 / 0.75max (ACIN 100V / 240V 60Hz, Io=100%, According to IEC60950-1 and DEN-AN)									
OUTPUT	VOLTAGE[V]	3.3	5	12	15	24	24	36	48	
	CURRENT[A]	30	30	12.5	10	6.3	6.3 (Peak 7.9)	4.2	3.2	
	LINE REGULATION[mV]	20max	20max	48max	60max	96max	96max	144max	192max	
	LOAD REGULATION[mV]	40max	40max	100max	120max	150max	150max	240max	240max	
	RIPPLE[mVp-p]	0 to +40°C *2	80max	80max	120max	120max	120max	240max	150max	150max
		-10 - 0°C *2	140max	140max	160max	160max	160max	320max	200max	200max
	RIPPLE NOISE[mVp-p]	0 to +40°C *2	120max	120max	150max	150max	150max	300max	250max	250max
		-10 - 0°C *2	160max	160max	180max	180max	180max	360max	300max	300max
	TEMPERATURE REGULATION[mV]	0 to +40°C	50max	50max	120max	150max	240max	240max	360max	480max
		-10 to +40°C	60max	60max	150max	180max	290max	290max	450max	600max
	DRIFT[mV]	20max	20max	48max	60max	96max	96max	144max	192max	
	START-UP TIME[ms]	350typ (ACIN 100V, Io=100%)								
	HOLD-UP TIME[ms]	20typ (ACIN 100V, Io=100%)								
OUTPUT VOLTAGE ADJUSTMENT RANGE[V]	2.85 to 3.63		4.50 to 5.50		Fixed ("Y"option is available for adjusting output voltage)					
OUTPUT VOLTAGE SETTING[V]	3.30 to 3.40	5.00 to 5.15	11.50 to 12.50	14.40 to 15.60	23.00 to 25.00	23.00 to 25.00	34.50 to 37.50	46.00 to 50.00		
PROTECTION CIRCUIT AND OTHERS	OVERCURRENT PROTECTION	Works over 105% of rating (works over 101% of peak current at option -H) and recovers automatically								
	OVERVOLTAGE PROTECTION	4.00 to 5.25	5.75 to 7.00	13.80 to 16.80	17.25 to 21.00	27.60 to 33.60	27.60 to 33.60	41.40 to 50.40	55.20 to 67.20	
	OPERATING INDICATION	Not provided								
	REMOTE SENSING	Not provided								
	REMOTE ON/OFF	Option (Refer to Instruction Manual)								
ISOLATION	INPUT-OUTPUT-RC	*6 AC3,000V 1minute, Cutoff current = 10mA, DC500V 50MΩ min (At Room Temperature)								
	INPUT-FG	AC2,000V 1minute, Cutoff current = 10mA, DC500V 50MΩ min (At Room Temperature)								
	OUTPUT-RC-FG	*6 AC500V 1minute, Cutoff current = 25mA, DC500V 50MΩ min (At Room Temperature)								
	OUTPUT-RC	*6 AC100V 1minute, Cutoff current = 25mA, DC100V 10MΩ min (At Room Temperature)								
ENVIRONMENT	OPERATING TEMP., HUMID. AND ALTITUDE *4	-10 to +70°C, 20 - 90%RH (Non condensing) (Refer to Instruction Manual 3.2), 3,000m (10,000feet) max								
	STORAGE TEMP., HUMID. AND ALTITUDE	-20 to +75°C, 20 - 90%RH (Non condensing), 9,000m (30,000feet) max								
	VIBRATION	10 - 55Hz, 19.6m/s <sup>2</sup> (2G), 3minutes period, 60minutes each along X, Y and Z axis								
	IMPACT	196.1m/s <sup>2</sup> (20G), 11ms, once each X, Y and Z axis								
SAFETY AND NOISE REGULATIONS	AGENCY APPROVALS	UL60950-1, C-UL (CSA60950-1), EN60950-1, EN60065, EN50178 Complies with DEN-AN								
	CONDUCTED NOISE	Complies with FCC-B, VCCI-B, CISPR-B, EN55011-B, EN55022-B								
	HARMONIC ATTENUATOR	Complies with IEC61000-3-2 (Class A) *8								
OTHERS	CASE SIZE/WEIGHT	75 X 37.0 X 160mm [2.95 X 1.46 X 6.30 inches] (W X H X D) / 390g max (with chassis & cover : 650g max)								
	COOLING METHOD	Convection (Refer to Instruction Manual 3.1 and 3.2) *4								

\*1 Specification is changed at option, refer to Instruction Manual.  
 \*2 This is the value that measured on measuring board with capacitor of 22 μF at 150mm from output terminal.  
 \*3 Drift is the change in DC output for an eight hour period after a half-hour warm-up at 25°C, with the input voltage held constant  
 \*4 at the rated input/output.  
 \*5 ( ) means peak current. There is a possibility that an internal device is damaged when the specification is exceeded. Please contact us about the detail.  
 \*6 Applicable when remote control (optional) is added.  
 \*7 Please contact us about dynamic load and input response.  
 \*8 Please contact us about another class.  
 \*9 To meet the specifications. Do not operate over-loaded condition.  
 \*10 Parallel operation is not possible.  
 \*11 Derating is required when operated with chassis and cover.  
 \*12 Sound noise may be generated by power supply in case of pulse load.



## Block diagram



LFA

## External view

※ External size of option is different from standard model.

Standard type

Chassis and cover type

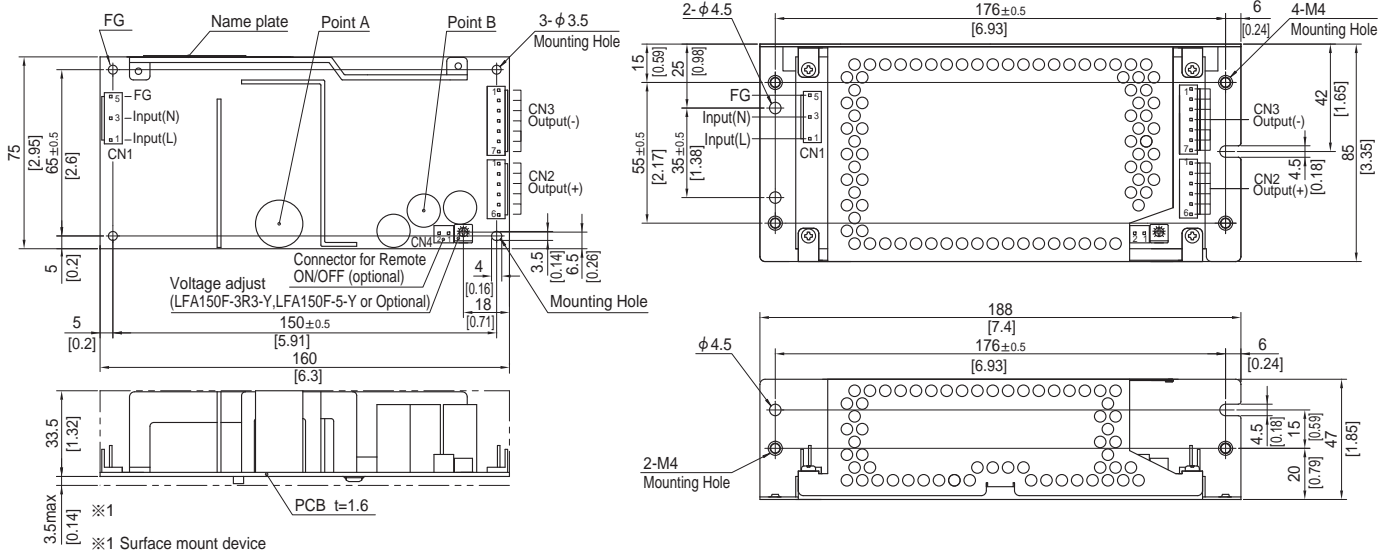

- ※ 4 Mounting holes are existing.
- ※ The back side of P.C.B. of the power supply is assembled some SMDs.
- Be attention not to bump against the attached area by vibration.
- ※ Use the spacer of 8mm length or more regarding insulation. And do not use press-fitting bush.
- ※ Point A, Point B are thermometry points. Please refer to Instruction Manual 3.

I/O Connector	Mating connector	Terminal
CN1	1-1123724-3	Chain 1123721-1
		Loose 1318912-1
CN2	1-1123723-6	Chain 1123721-1
		Loose 1318912-1
CN3	1-1123723-7	Chain 1123721-1
		Loose 1318912-1

(Mfr:Tyco Electronics)

- ※ I/O Connector is Mfr. Tyco Electronics
- ※ Option: -J1:VH(J.S.T) connector type.

### <PIN CONNECTION>

CN1		CN2		CN3	
Pin No.	Input	Pin No.	Output	Pin No.	Output
1	AC(L)	1 to 6	+V	1 to 7	-V
2					
3	AC(N)				
4					
5	FG				

※ Keep drawing current per pin below 5A for CN2,CN3.

- ※ Tolerance :  $\pm 1$  [ $\pm 0.04$ ]
- ※ Weight : 390g max (with chassis & cover : 650g max)
- ※ PCB material : CEM3
- ※ Optional chassis and cover material : Electric galvanizing steel board.
- ※ Dimensions in mm, [ ] =inches
- ※ Mounting torque (Mounting hole of chassis) :1.5N · m (16kgf · cm) max

### Connector type

CN4 Option (Mfr:J.S.T)	
PIN No.	Contents
1	RC(+)
2	RC(-)

### Barrier strip type

Model B2B-XH-A  
Mating Connector (Terminal)  
XHP-2  
( BXH-001T-P0.6  
or SXH-001T-P0.6 )

# LFA240F

LF A 240 F -□ -□

① ② ③ ④ ⑤ ⑥

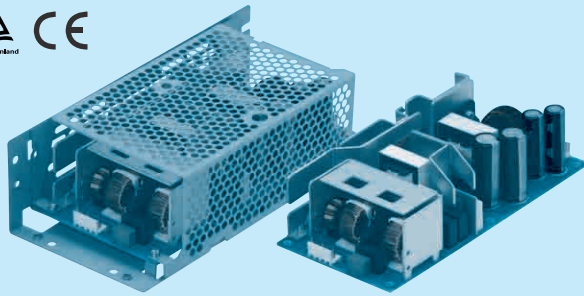

Recommended EMI/EMC Filter  
NAC-06-472



High voltage pulse noise type : NAP series  
Low leakage current type : NAM series

- ① Series name
- ② Single output
- ③ Output wattage
- ④ Universal input
- ⑤ Output voltage
- ⑥ Optional \*1
- C : with Coating
- G : Low leakage current
- H : with the function to be acceptable to output peak current (only 24V)
- J1 : VH(J.S.T.)connector type
- R : with Remote ON/OFF
- R2 : with Remote ON/OFF
- S : with Chassis
- SN : with Chassis & cover
- T : Vertical terminal block
- Y : with Potentiometer

This power supply is manufactured by SMD technology. The stress to P.C.B like twisting or bending causes the defect of the unit, so handle the unit with care.

Please refer to Instruction manual 5.

MODEL	LFA240F-24	LFA240F-24-H	LFA240F-36	LFA240F-48
MAX OUTPUT WATTAGE[W]	240	240 (300)	241.2	240
DC OUTPUT	24V 10A	24V 10 (12.5)A	36V 6.7A	48V 5A

## SPECIFICATIONS

	MODEL	LFA240F-24	LFA240F-24-H	LFA240F-36	LFA240F-48	
INPUT	VOLTAGE[V]	AC85 - 264 1 φ (Refer to Instruction Manual 1.1 and 3.2) *4				
	CURRENT[A]	ACIN 100V	3.3typ (Io=100%)			
		ACIN 200V	1.7typ (Io=100%)			
	FREQUENCY[Hz]	50 / 60 (47 - 63)				
	EFFICIENCY[%]	ACIN 100V	84.5typ	84.5typ	84.5typ	84.5typ
		ACIN 200V	87.5typ	87.5typ	87.5typ	87.5typ
	POWER FACTOR (Io=100%)	ACIN 100V	0.99typ			
ACIN 200V		0.95typ				
INRUSH CURRENT[A]	ACIN 100V	15 / 30typ (Io=100%) (Primary inrush current /Secondary inrush current) (More than 3 sec. to re-start)				
	ACIN 200V	30 / 30typ (Io=100%) (Primary inrush current /Secondary inrush current) (More than 3 sec. to re-start)				
LEAKAGE CURRENT[mA]	0.40 / 0.75max (ACIN 100V / 240V 60Hz, Io=100%, According to IEC60950-1 and DEN-AN)					
OUTPUT	VOLTAGE[V]	24	24	36	48	
	CURRENT[A]	10	10 (Peak12.5)	6.7	5	
	LINE REGULATION[mV]	96max	96max	144max	192max	
	LOAD REGULATION[mV]	150max	150max	240max	240max	
	RIPPLE[mVp-p]	0 to +40°C *2	120max	240max	150max	150max
		-10 -0°C *2	160max	320max	200max	200max
	RIPPLE NOISE[mVp-p]	0 to +40°C *2	150max	300max	250max	250max
		-10 -0°C *2	180max	360max	300max	300max
	TEMPERATURE REGULATION[mV]	0 to +40°C	240max	240max	360max	480max
		-10 to +40°C	290max	290max	450max	600max
	DRIFT[mV]	96max	96max	144max	192max	
	START-UP TIME[ms]	350typ (ACIN 100V, Io=100%)				
	HOLD-UP TIME[ms]	20typ (ACIN 100V, Io=100%)				
	OUTPUT VOLTAGE ADJUSTMENT RANGE[V]	Fixed ("Y"option is available for adjusting output voltage)				
OUTPUT VOLTAGE SETTING[V]	23.00 to 25.00	23.00 to 25.00	34.50 to 37.50	46.00 to 50.00		
PROTECTION CIRCUIT AND OTHERS	OVERCURRENT PROTECTION	Works over 105% of rating (works over 101% of peak current at option -H) and recovers automatically				
	OVERVOLTAGE PROTECTION	27.60 to 33.60	27.60 to 33.60	41.40 to 50.40	55.20 to 67.20	
	OPERATING INDICATION	Not provided				
	REMOTE SENSING	Not provided				
	REMOTE ON/OFF	Option (Refer to Instruction Manual)				
ISOLATION	INPUT-OUTPUT-RC	*6 AC3,000V 1minute, Cutoff current = 10mA, DC500V 50MΩ min (At Room Temperature)				
	INPUT-FG	AC2,000V 1minute, Cutoff current = 10mA, DC500V 50MΩ min (At Room Temperature)				
	OUTPUT-RC-FG	*6 AC500V 1minute, Cutoff current = 25mA, DC500V 50MΩ min (At Room Temperature)				
	OUTPUT-RC	*6 AC100V 1minute, Cutoff current = 25mA, DC100V 10MΩ min (At Room Temperature)				
ENVIRONMENT	OPERATING TEMP.,HUMID.AND ALTITUDE *4	-10 to +70°C, 20 - 90%RH (Non condensing) (Refer to Instruction Manual 3.2), 3,000m (10,000feet) max				
	STORAGE TEMP.,HUMID.AND ALTITUDE	-20 to +75°C, 20 - 90%RH (Non condensing), 9,000m (30,000feet) max				
	VIBRATION	10 - 55Hz, 19.6m/s <sup>2</sup> (2G), 3minutes period, 60minutes each along X, Y and Z axis				
	IMPACT	196.1m/s <sup>2</sup> (20G), 11ms, once each X, Y and Z axis				
SAFETY AND NOISE REGULATIONS	AGENCY APPROVALS	UL60950-1, C-UL (CSA60950-1), EN60950-1, EN60065, EN50178 Complies with DEN-AN				
	CONDUCTED NOISE	Complies with FCC-B, VCCI-B, CISPR-B, EN55011-B, EN55022-B				
	HARMONIC ATTENUATOR	Complies with IEC61000-3-2 (Class A) *8				
OTHERS	CASE SIZE/WEIGHT	84 X 46.5 X 180mm [3.31 X 1.83 X 7.09 inches] (W X H X D) / 550g max (with chassis & cover : 880g max)				
	COOLING METHOD	Convection (Refer to Instruction Manual 3.1 and 3.2) *4				

\*1 Specification is changed at option, refer to Instruction Manual.

\*2 This is the value that measured on measuring board with capacitor of 22 μF at 150mm from output terminal.  
Measured by 20MHz oscilloscope or Ripple-Noise meter (Equivalent to KEISOKU-GIKEN: RM103).

\*3 Drift is the change in DC output for an eight hour period after a half-hour warm-up at 25°C, with the input voltage held constant

at the rated input/output.

\*4 Derating is required.

\*5 ( ) means peak current. There is a possibility that an internal device is damaged when the specification is exceeded. Please contact us about the detail.

\*6 Applicable when remote control (optional) is added.

\*7 Please contact us about dynamic load and input response.

\*8 Please contact us about another class.

\* To meet the specifications. Do not operate over-loaded condition.

\* Parallel operation is not possible.

\* Derating is required when operated with chassis and cover.

\* Sound noise may be generated by power supply in case of pulse load.

## Block diagram



## External view

※ External size of option is different from standard model.

Standard type

Chassis and cover type

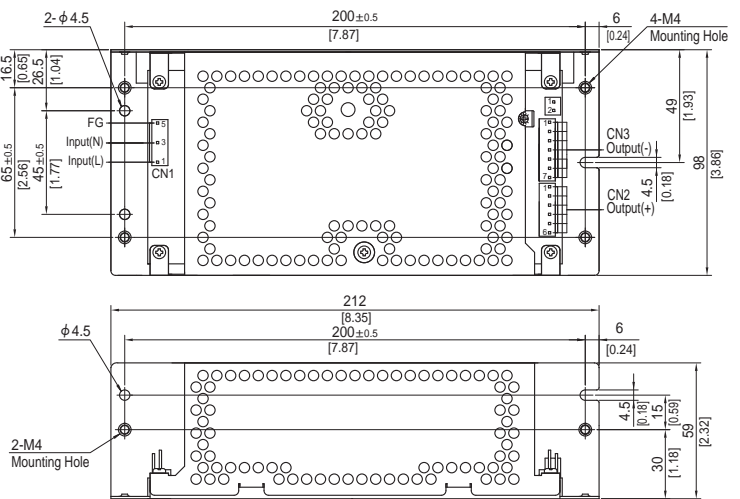
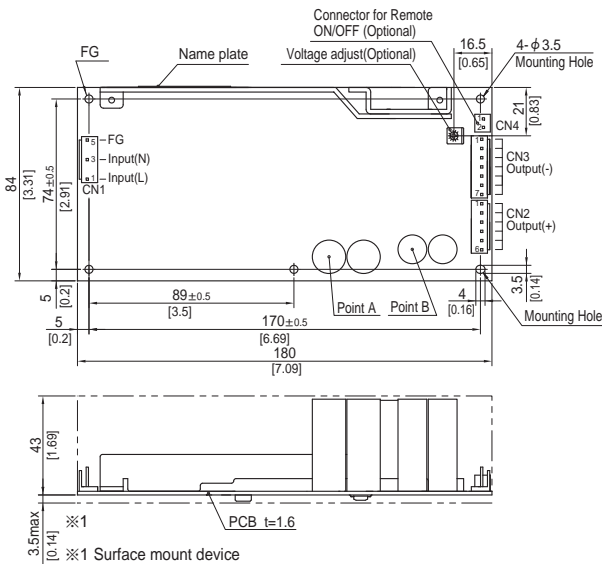

- ※ 5 Mounting holes are existing.
- ※ The back side of P.C.B. of the power supply is assembled some SMDs.
- Be attention not to bump against the attached area by vibration.
- ※ Use the spacer of 8mm length or more regarding insulation.
- And do not use press-fitting bush.
- ※ Point A, Point B are thermometry points. Please refer to Instruction Manual 3.

I/O Connector	Mating connector	Terminal
CN1	1-1123724-3	Chain 1123721-1
		Loose 1318912-1
		Chain 1123721-1
CN2	1-1123723-6	Loose 1318912-1
		Chain 1123721-1
		Loose 1318912-1
CN3	1-1123723-7	Chain 1123721-1
		Loose 1318912-1

(Mfr:Tyco Electronics)

- ※ I/O Connector is Mfr. Tyco Electronics
- ※ Option:-J1:VH(J.S.T) connector type.

### <PIN CONNECTION>

CN1		CN2		CN3	
Pin No.	Input	Pin No.	Output	Pin No.	Output
1	AC(L)	1 to 6	+V	1 to 7	-V
2					
3	AC(N)				
4					
5	FG				

※ Keep drawing current per pin below 5A for CN2,CN3.

- ※ Tolerance : ±1 [±0.04]
- ※ Weight : 550g max (with chassis & cover : 880g max)
- ※ PCB material : CEM3
- ※ Optional chassis and cover material : Electric galvanizing steel board.
- ※ Dimensions in mm, [ ]=inches
- ※ Mounting torque (Mounting hole of chassis) :1.5N · m (16kgf · cm) max

### Connector type

CN4 Option (Mfr:J.S.T)

PIN No.	Contents
1	RC(+)
2	RC(-)

### Barrier strip type

Model B2B-XH-A  
Mating Connector (Terminal)  
XHP-2  
( BXH-001T-P0.6  
or SXH-001T-P0.6 )

# LFA300F

LF A 300 F -□ -□  
 ① ② ③ ④ ⑤ ⑥



Recommended EMI/EMC Filter  
**NAC-06-472**



High voltage pulse noise type : NAP series  
 Low leakage current type : NAM series

- ① Series name
  - ② Single output
  - ③ Output wattage
  - ④ Universal input
  - ⑤ Output voltage
  - ⑥ Optional \*1
  - C : with Coating
  - G : Low leakage current
  - H : with the function to be acceptable to output peak current
  - (Only 24V, 30V, 36V and 48V)
  - J : EP (Tyco Electronics) connector type (Except 3.3V and 5V)
  - J1 : VH (J.S.T.) connector type (Except 3.3V and 5V)
  - R : with Remote ON/OFF
  - R2 : with Remote ON/OFF
  - S : with Chassis
  - SNF : with Chassis & cover & fan (Only 5V, 12V and 24V)
  - T1 : Horizontal terminal block
- Please refer to Instruction manual 5.

This power supply is manufactured by SMD technology. The stress to P.C.B like twisting or bending causes the defect of the unit, so handle the unit with care.

MODEL	LFA300F-3R3-TY	LFA300F-5-TY	LFA300F-12-TY	LFA300F-15-TY	LFA300F-24-TY	LFA300F-24-HTY	LFA300F-30-TY	LFA300F-36-TY	LFA300F-48-TY	
MAX OUTPUT WATTAGE[W]	*5 198	300	324	330	336	336 (456)	330	338.4	336	
DC OUTPUT	Convection	3.3V 40A	5V 40A	12V 17A	15V 14A	24V 12.5A	24V 12.5 (19A)	30V 10A	36V 8.4A	48V 6.3A
	Forced air	3.3V 60A	5V 60A	12V 27A	15V 22A	24V 14A	24V 14 (19A)	30V 11A	36V 9.4A	48V 7A

## SPECIFICATIONS

	MODEL	LFA300F-3R3-TY	LFA300F-5-TY	LFA300F-12-TY	LFA300F-15-TY	LFA300F-24-TY	LFA300F-24-HTY	LFA300F-30-TY	LFA300F-36-TY	LFA300F-48-TY								
INPUT	VOLTAGE[V]	AC85 - 264 1 φ (Refer to Instruction Manual 1.1 and 3.2) *4																
	CURRENT[A]	ACIN 100V	2.7typ (Io=100%)		4.1typ (Io=100%)													
		ACIN 200V	1.4typ (Io=100%)		2.0typ (Io=100%)													
	FREQUENCY[Hz]	50 / 60 (47 - 63)																
	EFFICIENCY[%]	ACIN 100V	75.0typ	79.0typ	80.0typ	81.5typ	85.0typ	85.0typ	85.5typ	85.5typ	85.5typ							
		ACIN 200V	77.0typ	82.5typ	83.0typ	84.5typ	88.0typ	88.0typ	88.0typ	88.0typ	88.0typ							
	POWER FACTOR (Io=100%)	ACIN 100V	0.98typ		0.99typ													
		ACIN 200V	0.92typ		0.95typ													
INRUSH CURRENT[A]	ACIN 100V	15 / 30typ (Io=100%) (Primary inrush current /Secondary inrush current) (More then 3 sec. to re-start)																
	ACIN 200V	30 / 30typ (Io=100%) (Primary inrush current /Secondary inrush current) (More then 3 sec. to re-start)																
LEAKAGE CURRENT[ma]	0.45 / 0.75max (ACIN 100V / 240V 60Hz, Io=100%, According to IEC60950-1 and DEN-AN)																	
OUTPUT	VOLTAGE[V]	3.3	5	12	15	24	24	30	36	48								
	CURRENT[A]	Convection	40	40	17	14	12.5	12.5 (Peak19)	10	8.4	6.3							
		Forced air	60	60	27	22	14	14 (Peak19)	11	9.4	7							
	LINE REGULATION[mV]	*7 20max	20max	48max	60max	96max	96max	144max	144max	192max								
	LOAD REGULATION[mV]	*7 40max	40max	100max	120max	150max	150max	240max	240max	240max								
	RIPPLE[mVp-p]	0 to +40C *2	80max	80max	120max	120max	120max	240max	150max	150max	150max							
		-10-0C *2	140max	140max	160max	160max	160max	320max	200max	200max	200max							
	RIPPLE NOISE[mVp-p]	0 to +40C *2	120max	120max	150max	150max	150max	300max	250max	250max	250max							
		-10-0C *2	160max	160max	180max	180max	180max	360max	300max	300max	300max							
	TEMPERATURE REGULATION[mV]	0 to +40C	50max	50max	120max	150max	240max	240max	360max	360max	480max							
		-10 to +40C	60max	60max	150max	180max	290max	290max	450max	450max	600max							
	DRIFT[mV]	*3 20max	20max	48max	60max	96max	96max	144max	144max	192max								
	START-UP TIME[ms]	350typ (ACIN 100V, Io=100%)																
HOLD-UP TIME[ms]	20typ (ACIN 100V, Io=100%)																	
OUTPUT VOLTAGE ADJUSTMENT RANGE[V]	2.85 to 3.63		4.50 to 5.50		10.80 to 13.20		13.50 to 16.50		21.60 to 27.50		21.60 to 27.50		27.00 to 33.00		32.40 to 39.60		39.60 to 52.80	
OUTPUT VOLTAGE SETTING[V]	3.30 to 3.40		5.00 to 5.15		12.00 to 12.48		15.00 to 15.60		24.00 to 24.96		24.00 to 24.96		30.00 to 31.20		36.00 to 37.44		48.00 to 49.92	
PROTECTION CIRCUIT AND OTHERS	OVERCURRENT PROTECTION	Works over 105% of rating (works over 101% of peak current at option -H) and recovers automatically																
	OVERVOLTAGE PROTECTION	4.00 to 5.25	5.75 to 7.00	13.80 to 16.80	17.25 to 21.00	27.60 to 33.60	27.60 to 33.60	34.50 to 42.00	41.40 to 50.40	55.20 to 67.20								
	OPERATING INDICATION	Not provided																
	REMOTE SENSING	Not provided																
REMOTE ON/OFF	Option (Refer to Instruction Manual)																	
ISOLATION	INPUT-OUTPUT-RC	*6 AC3,000V 1minute, Cutoff current = 10mA, DC500V 50MΩ min (At Room Temperature)																
	INPUT-FG	AC2,000V 1minute, Cutoff current = 10mA, DC500V 50MΩ min (At Room Temperature)																
	OUTPUT-RC-FG	*6 AC500V 1minute, Cutoff current = 25mA, DC500V 50MΩ min (At Room Temperature)																
	OUTPUT-RC	*6 AC100V 1minute, Cutoff current = 25mA, DC100V 10MΩ min (At Room Temperature)																
ENVIRONMENT	OPERATING TEMP., HUMID. AND ALTITUDE	*4 -10 to +70°C, 20 - 90%RH (Non condensing) (Refer to Instruction Manual 3.2), 3,000m (10,000feet) max																
	STORAGE TEMP., HUMID. AND ALTITUDE	-20 to +75°C, 20 - 90%RH (Non condensing), 9,000m (30,000feet) max																
	VIBRATION	10 - 55Hz, 19.6m/s <sup>2</sup> (2G), 3minutes period, 60minutes each along X, Y and Z axis																
	IMPACT	196.1m/s <sup>2</sup> (20G), 11ms, once each X, Y and Z axis																
SAFETY AND NOISE REGULATIONS	AGENCY APPROVALS	UL60950-1, C-UL (CSA60950-1), EN60950-1, EN60065, EN50178 Complies with DEN-AN																
	CONDUCTED NOISE	Complies with FCC-B, VCCI-B, CISPR-B, EN55011-B, EN55022-B																
	HARMONIC ATTENUATOR	Complies with IEC61000-3-2 (Class A) *8																
OTHERS	CASE SIZE/WEIGHT	95X52.5X222mm [3.74X2.07X8.74 inches] (W X H X D) (without terminal block) / 810g max (with chassis & cover : 1,270g max)																
	COOLING METHOD	Convection / Forced air (Refer to Instruction Manual 3.1 and 3.2) *4																

\*1 Specification is changed at option, refer to Instruction Manual.  
 \*2 This is the value that measured on measuring board with capacitor of 22μF at 150mm from output terminal.  
 \*3 Drift is the change in DC output for an eight hour period after a half-hour warm-up at 25°C, with the input voltage held constant  
 \*4 at the rated input/output.  
 \*5 ( ) means peak current. There is a possibility that an internal device is damaged when the specification is exceeded. Please contact us about the detail.  
 \*6 Applicable when remote control (optional) is added.  
 \*7 Please contact us about dynamic load and input response.  
 \*8 Please contact us about another class.  
 \*9 To meet the specifications. Do not operate over-loaded condition.  
 \*10 Parallel operation is not possible.  
 \*11 Derating is required when operated with chassis and cover.  
 \*12 Sound noise may be generated by power supply in case of pulse load.

## Block diagram



## External view

※ External size of option is different from standard model.

Standard type



Connector type

CN4 Option (Mfr.:J.S.T)

PIN No.	Contents
1	RC(+)
2	RC(-)

Barrier strip type

Model B2B-XH-A  
Mating Connector (Terminal)  
XHP-2  
( BXH-001T-P0.6  
or SXH-001T-P0.6 )



- ※ 5 Mounting holes are existing.
- ※ The back side of P.C.B. of the power supply is assembled some SMDs.
- Be attention not to bump against the attached area by vibration.
- ※ Use the spacer of 8mm length or more regarding insulation. And do not use press-fitting bush.
- ※ Point A, Point B, Point C, Point D are thermometry points. Please refer to Instruction Manual 3.
- ※ Keep drawing current per pin below 20A for TB2.

- ※ Tolerance :  $\pm 1$  [ $\pm 0.04$ ]
- ※ Weight : 810g max (with chassis & cover : 1,270g max)
- ※ PCB material : CEM3
- ※ Dimensions in mm, [ ]=inches
- ※ Screw tightening torque : M4 1.6N · m (16.9kgf · cm) max



# Mouser Electronics

Authorized Distributor

Click to View Pricing, Inventory, Delivery & Lifecycle Information:

## Cosel:

[LFA100F-36-J1R2](#) [LFA100F-48-SGY](#) [LFA100F-24-SCR2](#) [LFA150F-36-CGR](#) [LFA150F-36-J1](#) [LFA240F-36-SNT](#)  
[LFA75F-5-SJ1](#) [LFA75F-5-SN](#) [LFA75F-5-SNJ1](#) [LFA75F-5-SNY](#) [LFA75F-48-SN](#) [LFA75F-48-SNJ1](#) [LFA75F-48-SNY](#)  
[LFA75F-5](#) [LFA75F-5-C](#) [LFA75F-5-G](#) [LFA75F-3R3-GJ1Y](#) [LFA75F-3R3-SNJ1Y](#) [LFA75F-3R3-Y](#) [LFA75F-48-C](#)  
[LFA75F-48-GJ1](#) [LFA75F-48-S](#) [LFA75F-36](#) [LFA75F-36-CJ1](#) [LFA75F-36-G](#) [LFA75F-36-SNJ1](#) [LFA75F-36-SNY](#)  
[LFA75F-36-Y](#) [LFA75F-15-SNJ1Y](#) [LFA75F-24-GJ1](#) [LFA75F-24-J1Y](#) [LFA75F-24-S](#) [LFA75F-24-SJ1Y](#) [LFA75F-24-](#)  
[SNJ1Y](#) [LFA75F-12-SNY](#) [LFA75F-15-C](#) [LFA75F-15-GJ1](#) [LFA75F-15-S](#) [LFA75F-15-SN](#) [LFA75F-15-SNJ1](#) [LFA50F-5-](#)  
[Y](#) [LFA75F-12-CJ1](#) [LFA75F-12-GJ1](#) [LFA75F-12-J1Y](#) [LFA75F-12-S](#) [LFA75F-12-SN](#) [LFA50F-5-C](#) [LFA50F-5-G](#)  
[LFA50F-5-J1](#) [LFA50F-5-J1Y](#) [LFA50F-5-SJ1](#) [LFA50F-5-SNJ1](#) [LFA50F-48-G](#) [LFA50F-48-S](#) [LFA50F-48-SN](#) [LFA50F-](#)  
[48-SNJ1](#) [LFA50F-48-SNY](#) [LFA50F-48-SY](#) [LFA50F-3R3-J1Y](#) [LFA50F-3R3-SNJ1Y](#) [LFA50F-3R3-SNY](#) [LFA50F-3R3-](#)  
[SY](#) [LFA50F-48](#) [LFA50F-48-CJ1](#) [LFA50F-36-G](#) [LFA50F-36-GJ1](#) [LFA50F-36-J1](#) [LFA50F-36-SNJ1](#) [LFA50F-36-](#)  
[SNJ1Y](#) [LFA50F-3R3-CJ1Y](#) [LFA50F-24-SJ1](#) [LFA50F-24-SN](#) [LFA50F-24-SNCGJ1Y](#) [LFA50F-24-SNGJ1](#) [LFA50F-24-](#)  
[SNY](#) [LFA50F-36-C](#) [LFA50F-15-SNJ1](#) [LFA50F-15-SNJ1Y](#) [LFA50F-24](#) [LFA50F-24-G](#) [LFA50F-24-GJ1](#) [LFA50F-24-S](#)  
[LFA50F-12-SNY](#) [LFA50F-12-Y](#) [LFA50F-15-C](#) [LFA50F-15-CJ1Y](#) [LFA50F-15-J1Y](#) [LFA50F-15-SJ1Y](#) [LFA50F-12-GJ1](#)  
[LFA50F-12-J1Y](#) [LFA50F-12-S](#) [LFA50F-12-SJ1Y](#) [LFA50F-12-SNCJ1](#) [LFA50F-12-SNJ1](#) [LFA30F-5-SJ1Y](#) [LFA30F-5-](#)  
[SNC](#) [LFA30F-5-SNCJ1](#) [LFA30F-5-SNJ1Y](#) [LFA50F-12-C](#) [LFA50F-12-G](#)



Компания «ЭлектроПласт» предлагает заключение долгосрочных отношений при поставках импортных электронных компонентов на взаимовыгодных условиях!

Наши преимущества:

- Оперативные поставки широкого спектра электронных компонентов отечественного и импортного производства напрямую от производителей и с крупнейших мировых складов;
- Поставка более 17-ти миллионов наименований электронных компонентов;
- Поставка сложных, дефицитных, либо снятых с производства позиций;
- Оперативные сроки поставки под заказ (от 5 рабочих дней);
- Экспресс доставка в любую точку России;
- Техническая поддержка проекта, помощь в подборе аналогов, поставка прототипов;
- Система менеджмента качества сертифицирована по Международному стандарту ISO 9001;
- Лицензия ФСБ на осуществление работ с использованием сведений, составляющих государственную тайну;
- Поставка специализированных компонентов (Xilinx, Altera, Analog Devices, Intersil, Interpoint, Microsemi, Aeroflex, Peregrine, Syfer, Eurofarad, Texas Instrument, Miteq, Cobham, E2V, MA-COM, Hittite, Mini-Circuits, General Dynamics и др.);

Помимо этого, одним из направлений компании «ЭлектроПласт» является направление «Источники питания». Мы предлагаем Вам помощь Конструкторского отдела:

- Подбор оптимального решения, техническое обоснование при выборе компонента;
- Подбор аналогов;
- Консультации по применению компонента;
- Поставка образцов и прототипов;
- Техническая поддержка проекта;
- Защита от снятия компонента с производства.



#### Как с нами связаться

**Телефон:** 8 (812) 309 58 32 (многоканальный)

**Факс:** 8 (812) 320-02-42

**Электронная почта:** [org@eplast1.ru](mailto:org@eplast1.ru)

**Адрес:** 198099, г. Санкт-Петербург, ул. Калинина, дом 2, корпус 4, литера А.