

Typical Applications

The HMC992LP5E is ideal for:

- Cellular/3G Infrastructure
- WiBro / WiMAX / 4G
- Microwave Radio & VSAT
- Test Equipment and Sensors
- IF & RF Applications

Features

- Wide Gain Control Range: -10 to +38 dB
- High Output IP3: +40 dBm
- Positive Analog Control: 0V to +5V
- Configurable with 1 or 2 Attenuators
- 32 Lead 5x5 mm SMT Package: 25 mm²

Functional Diagram

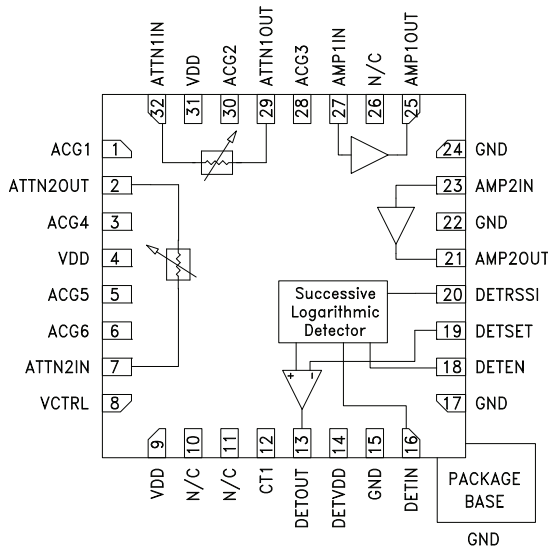

General Description

The HMC992LP5E is an IF analog controlled variable gain amplifier composed of two identical voltage variable attenuators in combination with an InGaP HBT gain block MMIC amplifier which operates from 0.1 to 0.8 GHz, and can be controlled to provide anywhere from -10 dB attenuation, to 40 dB of gain. The HMC992LP5E delivers noise figure of 6 dB in its maximum gain state, with output IP3 of up to +40 dBm. The HMC992LP5E is housed in a RoHS compliant 5x5 mm QFN leadless package, and requires no external matching components.

Electrical Specifications,

$T_A = +25^\circ\text{C}$, 50 Ohm System, $V_{dd} = ATTN1V_{dd} = ATTN2V_{dd} = DETV_{dd} = +5V$ [1]

Parameter	Frequency	Min.	Typ.	Max.	Units
Gain (VCTRL = 0V)	1 Attenuator Operation 0.1 - 0.5 GHz 0.8 GHz	35	40 36		dB dB
	2 Attenuator Operation 0.1 - 0.3 GHz 0.5 GHz 0.8 GHz	32	38 36 33		dB
Gain Control Range	1 Attenuator Operation 0.1 - 0.5 GHz 0.8 GHz		25 20		dB
	2 Attenuator Operation 0.1 - 0.5 GHz 0.8 GHz		48 42		dB
Input Return Loss (VCTRL = 0V)	1 Attenuator Operation 0.1 - 0.5 GHz 0.8 GHz		15 12		dB
	2 Attenuator Operation 0.1 - 0.8 GHz		12		dB
Output Return Loss (VCTRL = 0V)	1 Attenuator Operation 0.1 GHz 0.3 - 0.5 GHz 0.8 GHz		11 12 14		dB
	2 Attenuator Operation 0.1 - 0.8 GHz		12		dB



**IF AUTOMATIC GAIN CONTROLLER
(IF-AGC), 50 - 800 MHz**

Electrical Specifications (continued),

$T_A = +25^\circ\text{C}$, 50 Ohm System, $V_{dd} = \text{ATTN1}V_{dd} = \text{ATTN2}V_{dd} = \text{DET}V_{DD} = +5\text{V}$ [1]

Parameter	Frequency	Min.	Typ.	Max.	Units
Output Third Order Intercept Point (Two-Tone Output Power= 0 dBm Each Tone) (VCTRL = 0V)	0.1 GHz		42		dBm
	0.3 GHz		44		
	0.5 GHz		39		
	0.8 GHz		35		
Output Power for 1dB Compression (VCTRL = 0V)	0.1 GHz		18.5		dBm
	0.3 GHz		18.9		
	0.5 GHz		19		
	0.8 GHz		18.8		
Noise Figure (VCTRL = 0V)			6		dB
Supply Current (I _{dd})			215		mA
Power Detector					
	Typ.	Typ.	Typ.		Units
Input Frequency	100	500	900		MHz
±3 dB Dynamic Range	61	61	62		dB
DETOUT Slope	17.2	17.2	17.1		mV/dB
DETOUT Intercept	-68.1	-68.6	-68.9		dBm
Variation of DETOUT with Temperature from -40°C to +85°C @20dBm Input	-1.3	-1.2	-1.2		dB

[1] Unless otherwise noted, test conditions: ATTN1 + ATTN2 + AMP1 + AMP2 in cascade.

IF AUTOMATIC GAIN CONTROLLER (IF-AGC), 50 - 800 MHz

Gain vs. VCTRL @ 100MHz^[1]

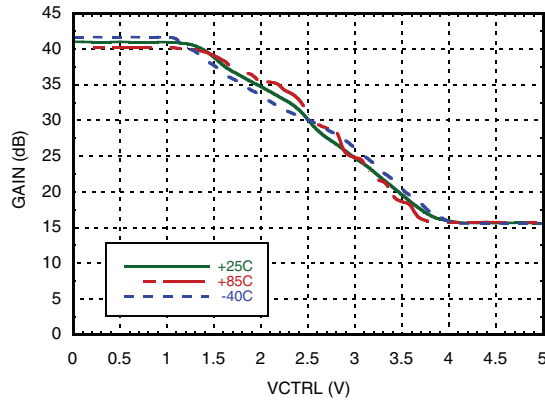

Gain vs. VCTRL @ 100MHz^[2]

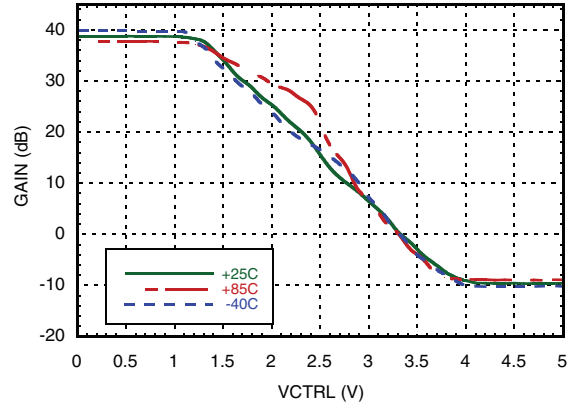

Gain vs. VCTRL @ 300MHz^[1]

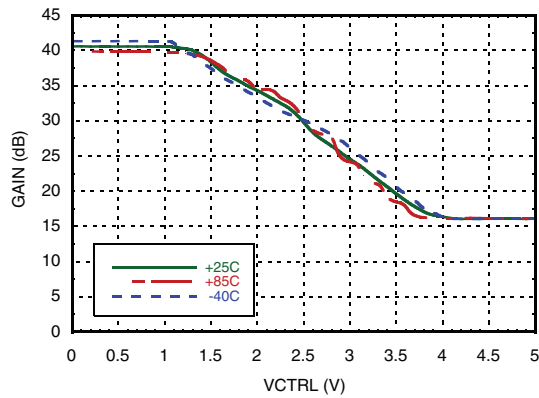

Gain vs. VCTRL @ 300MHz^[2]

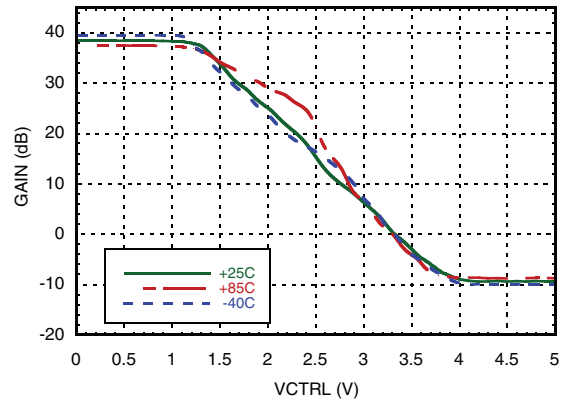

Gain vs. VCTRL @ 500MHz^[1]

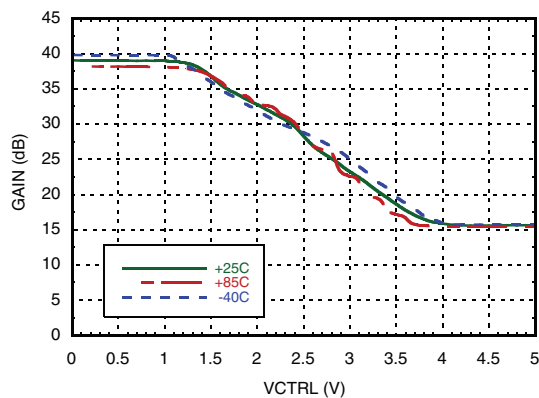

Gain vs. VCTRL @ 500MHz^[2]

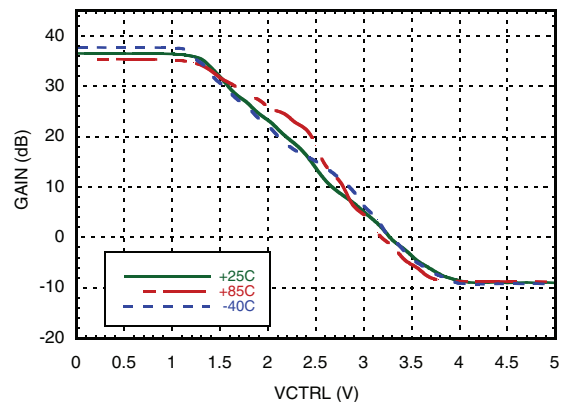

[1] ATTN1 + AMP1 + AMP2, CT1=0V

[2] ATTN1 + ATTN2 + AMP1 + AMP2, CT1=0V

IF AUTOMATIC GAIN CONTROLLER (IF-AGC), 50 - 800 MHz

Gain vs. VCTRL @ 800MHz^[1]

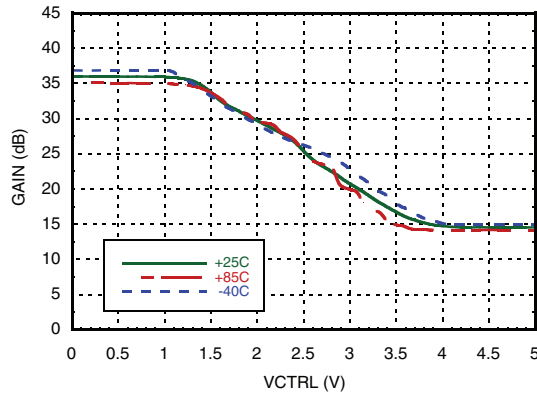

Gain vs. VCTRL @ 800MHz^[2]

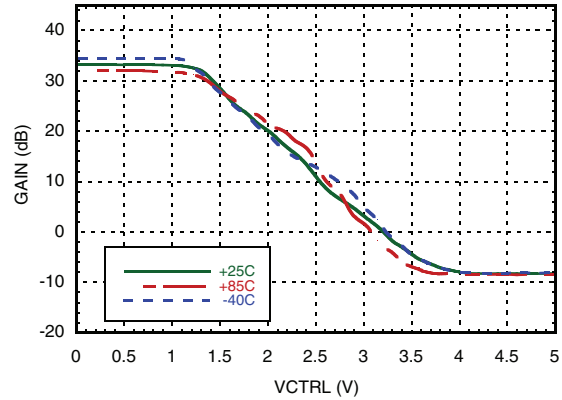

Gain vs. Frequency over VCTRL^{[1][3]}

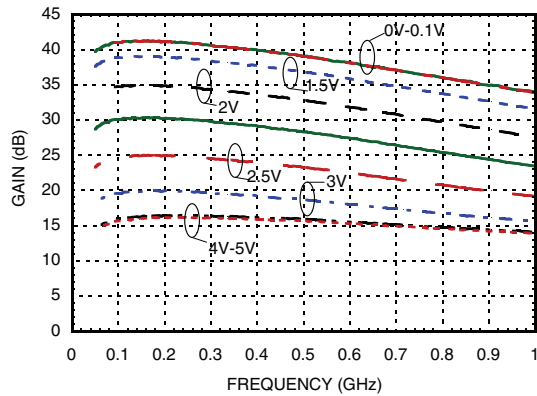

Gain vs. Frequency over VCTRL^{[2][3]}

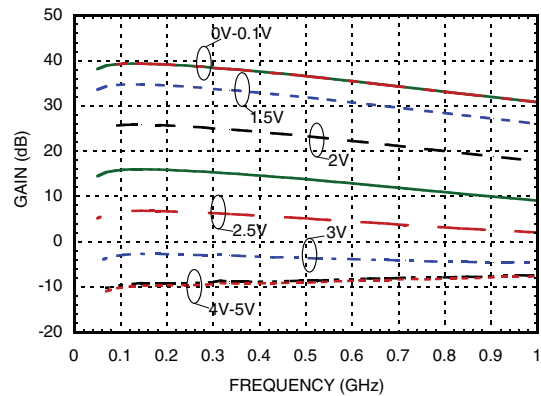

Input Return Loss vs. VCTRL @ 100MHz^[1]

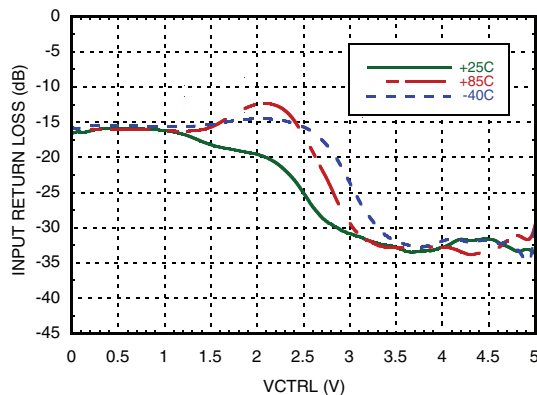

Input Return Loss vs. VCTRL @ 100MHz^[2]

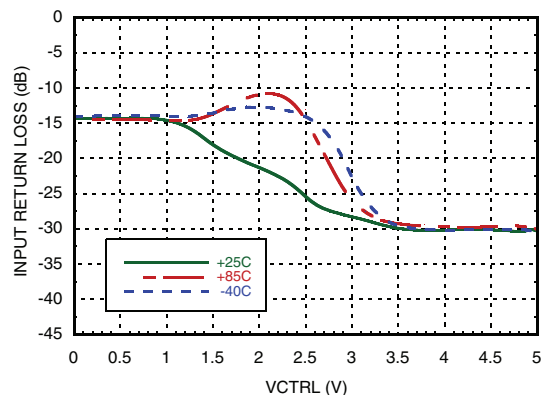

[1] ATTN1 + AMP1 + AMP2, CT1=0V

[2] ATTN1 + ATTN2 + AMP1 + AMP2, CT1=0V

[3] At 25°C

IF AUTOMATIC GAIN CONTROLLER (IF-AGC), 50 - 800 MHz

AUTOMATIC GAIN CONTROL - SMT

Input Return Loss vs. VCTRL @ 300MHz^[1]

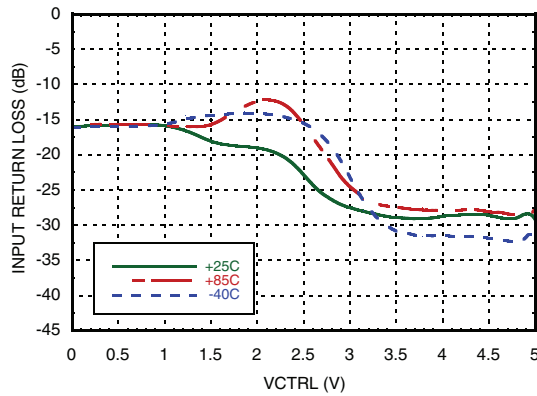

Input Return Loss vs. VCTRL @ 300MHz^[2]

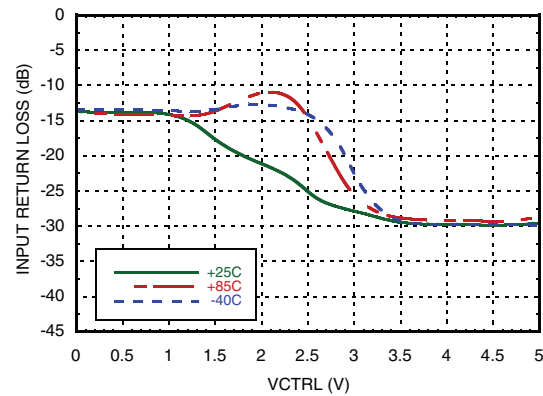

Input Return Loss vs. VCTRL @ 500MHz^[1]

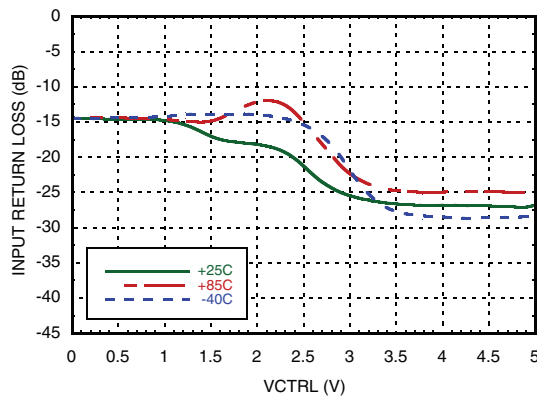

Input Return Loss vs. VCTRL @ 500MHz^[2]

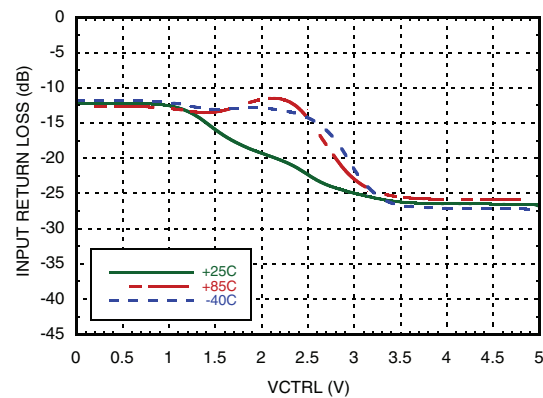

Input Return Loss vs. VCTRL @ 800MHz^[1]

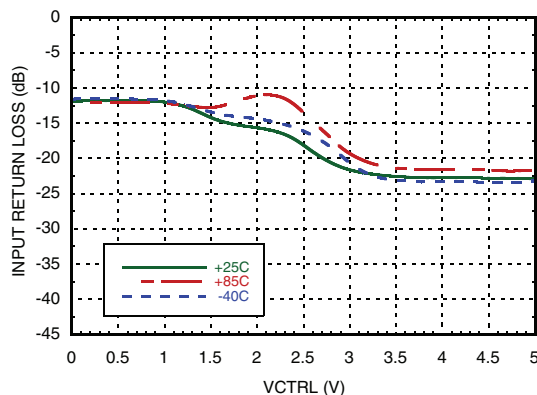

Input Return Loss vs. VCTRL @ 800MHz^[2]

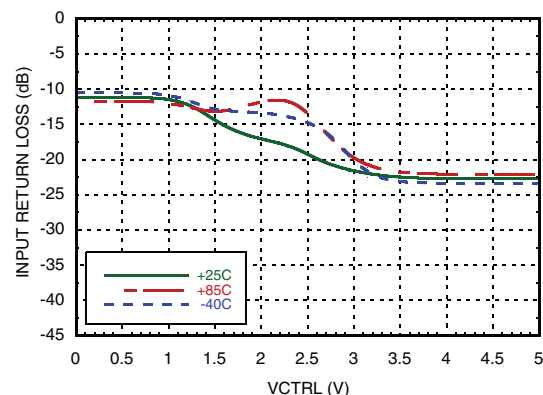

[1] ATTN1 + AMP1 + AMP2, CT1=0V

[2] ATTN1 + ATTN2 + AMP1 + AMP2, CT1=0V



IF AUTOMATIC GAIN CONTROLLER (IF-AGC), 50 - 800 MHz

Output Return Loss vs. VCTRL
@ 100MHz^[1]

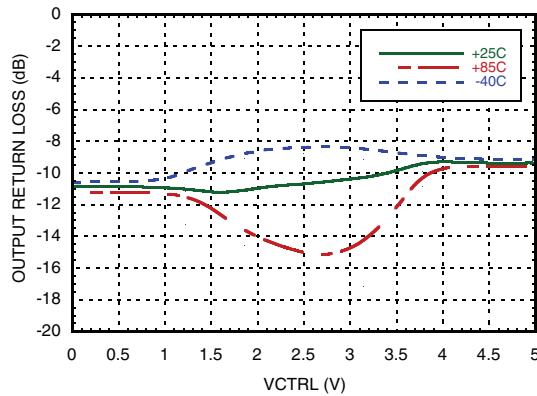

Output Return Loss vs. VCTRL
@ 100MHz^[2]

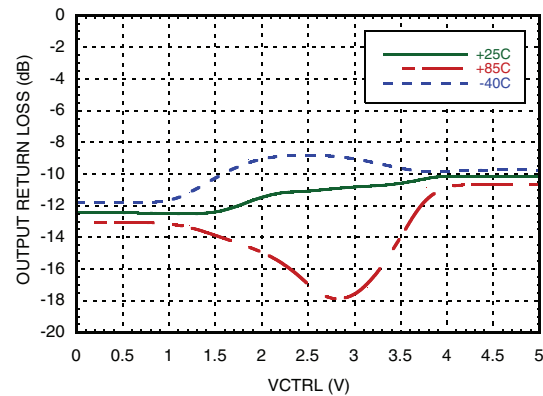

Output Return Loss vs. VCTRL
@ 300MHz^[1]

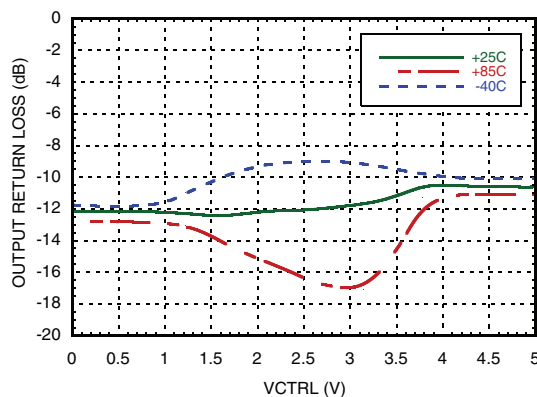

Output Return Loss vs. VCTRL
@ 300MHz^[2]

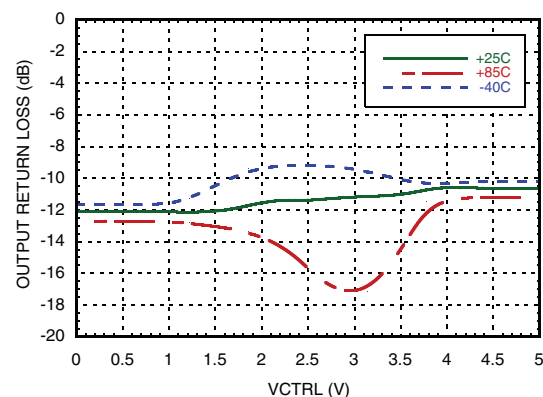

Output Return Loss vs. VCTRL
@ 500MHz^[1]

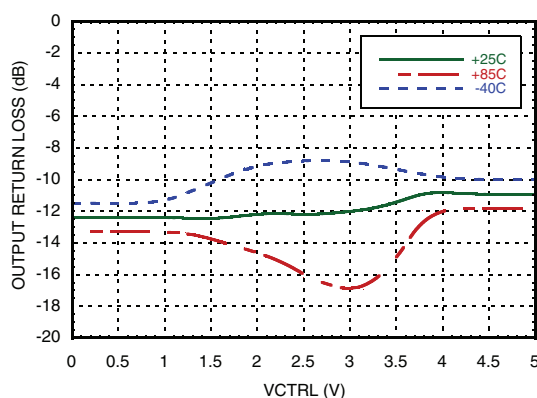

Output Return Loss vs. VCTRL
@ 500MHz^[2]

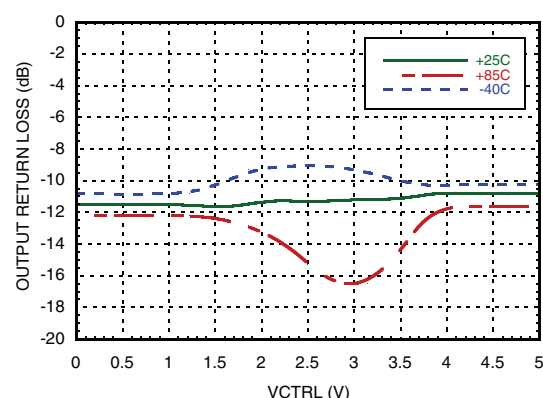

[1] ATTN1 + AMP1 + AMP2, CT1=0V

[2] ATTN1 + ATTN2 + AMP1 + AMP2, CT1=0V



IF AUTOMATIC GAIN CONTROLLER (IF-AGC), 50 - 800 MHz

AUTOMATIC GAIN CONTROL - SMT

Output Return Loss vs. VCTRL @ 800MHz^[1]

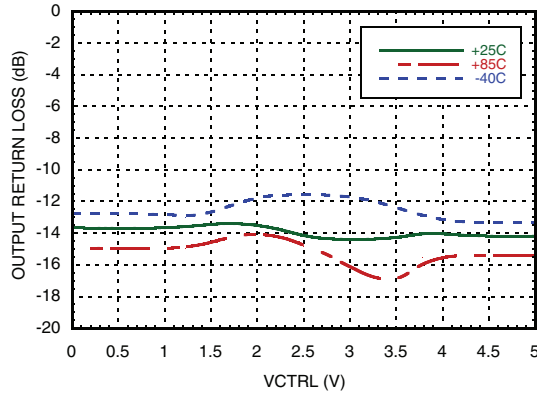

Output Return Loss vs. VCTRL @ 800MHz^[2]

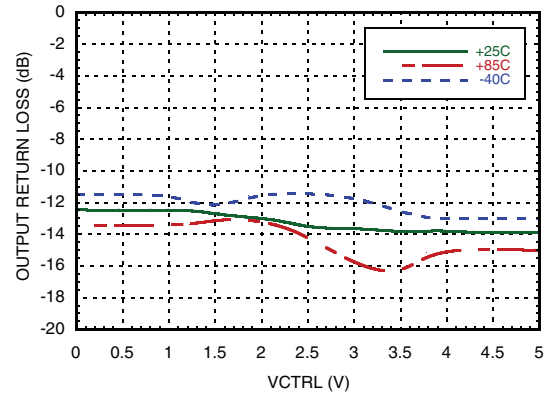

Output IP3 vs. VCTRL @ 100MHz^[1]

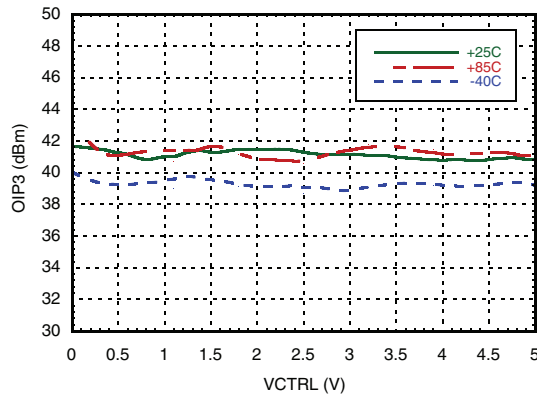

Output IP3 vs. VCTRL @ 300MHz^[1]

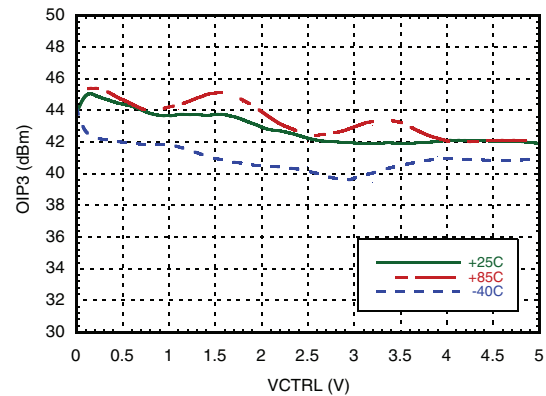

Output IP3 vs. VCTRL @ 500MHz^[1]

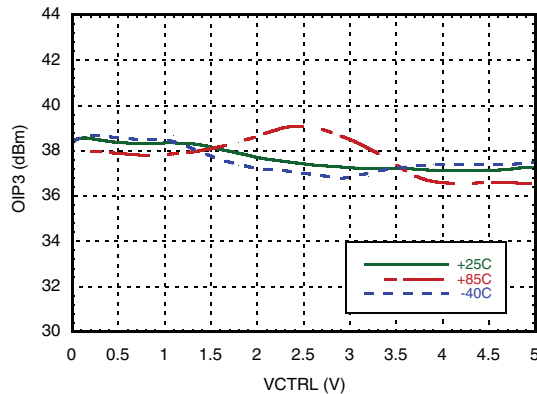

Output IP3 vs. VCTRL @ 800MHz^[1]

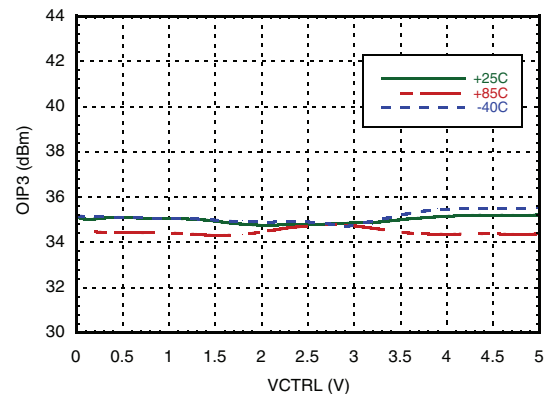

[1] ATTN1 + AMP1 + AMP2, CT1=0V

[2] ATTN1 + ATTN2 + AMP1 + AMP2, CT1=0V

IF AUTOMATIC GAIN CONTROLLER (IF-AGC), 50 - 800 MHz

Output IP2 vs. Frequency over VCTRL [1] [2]

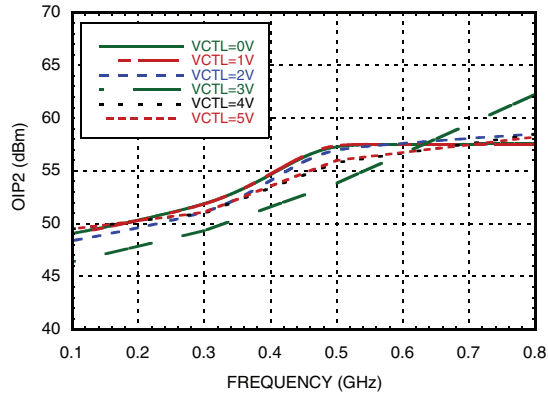

Output IP2 vs. Frequency over Temperature [1] [3]

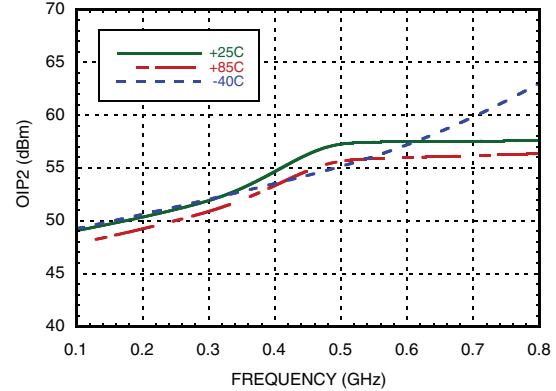

Input IP3 vs. Frequency over VCTRL [1][2][5]

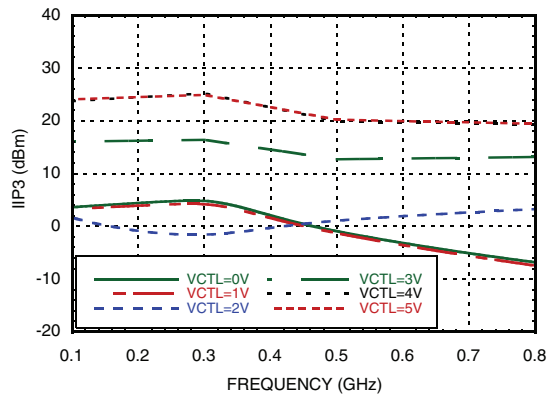

Input IP3 vs. Frequency over Temperature [1][3][5]

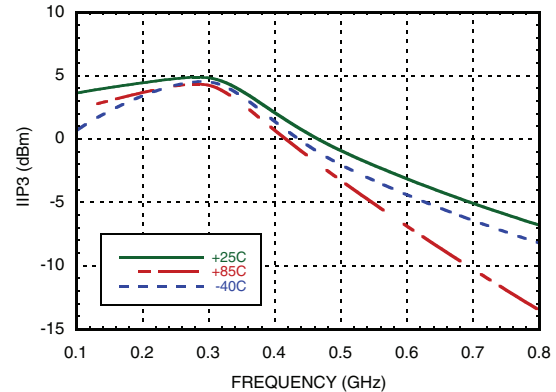

Output P1dB vs. Frequency over Temperature [1] [4]

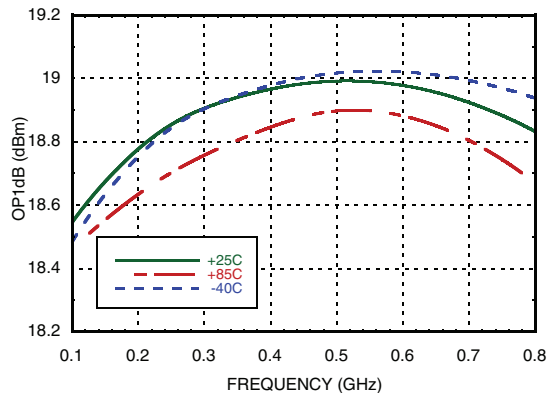

Noise Figure vs. Frequency over Temperature [1] [3]

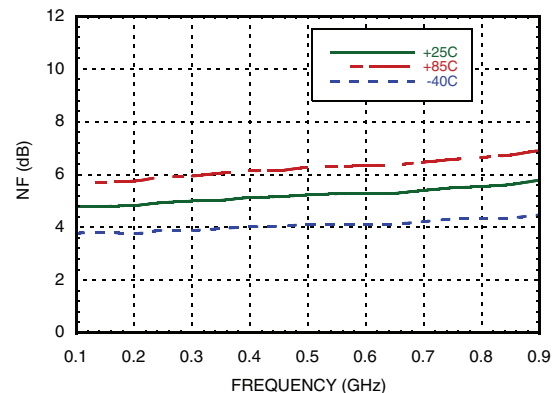

[1] ATTN1 + AMP1 + AMP2

[2] At 25°C

[3] VCTRL= 0V

[4] VCTRL= 4V

[5] CT1=0V



IF AUTOMATIC GAIN CONTROLLER (IF-AGC), 50 - 800 MHz

Absolute Maximum Ratings

VDD, DETVDD, DETEN, DETSET, DETRSSI, AMP1OUT, AMP2OUT	+5.6 V
VCTRL	-0.6V to VDD+0.6V
ATTN1IN, ATTN2IN Input Power	+20 dBm
AMP1IN RF Input Power	+10 dBm
AMP2IN RF Input Power	+15 dBm
DETOUR Output Current	5 mA
DETIN RF Input Power	12 dBm
Junction Temperature	125°C

Continuous Pdiss (T=85 °C) Derate 78.88 mW/°C above 85 °C	3.16 W
Thermal Resistance (R _{th}) (junction to package bottom)	12.68°C/W
Storage Temperature	-65 to +150 °C
Operating Temperature	-40 to +85 °C
ESD Sensitivity (HBM)	Class 1B



**ELECTROSTATIC SENSITIVE DEVICE
OBSERVE HANDLING PRECAUTIONS**

Outline Drawing

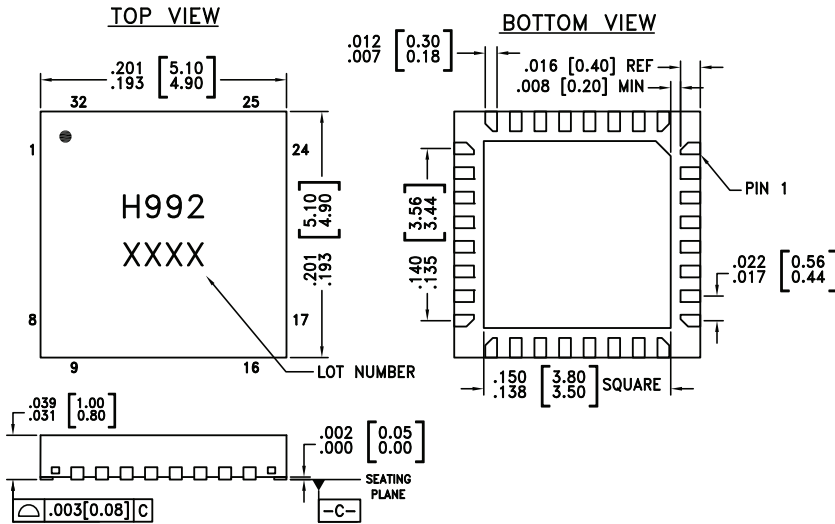

NOTES:

1. PACKAGE BODY MATERIAL: LOW STRESS INJECTION MOLDED PLASTIC SILICA AND SILICON IMPREGNATED.
2. LEAD AND GROUND PADDLE MATERIAL: COPPER ALLOY.
3. LEAD AND GROUND PADDLE PLATING: 100% MATTE TIN.
4. DIMENSIONS ARE IN INCHES [MILLIMETERS].
5. LEAD SPACING TOLERANCE IS NON-CUMULATIVE.
6. CHARACTERS TO BE HELVETICA MEDIUM, .025 HIGH, WHITE INK, OR LASER MARK LOCATED APPROX. AS SHOWN.
7. PAD BURR LENGTH SHALL BE 0.15mm MAX. PAD BURR HEIGHT SHALL BE 0.25mm MAX.
8. PACKAGE WARP SHALL NOT EXCEED 0.05mm
9. ALL GROUND LEADS AND GROUND PADDLE MUST BE SOLDERED TO PCB RF GROUND.
10. REFER TO HITTITE APPLICATION NOTE FOR SUGGESTED PCB LAND PATTERN.

Package Information

Part Number	Package Body Material	Lead Finish	MSL Rating	Package Marking ^[1]
HMC992LP5E	RoHS-compliant Low Stress Injection Molded Plastic	100% matte Sn	MSL1 ^[2]	H992 XXXX

[1] 4-Digit lot number XXXX

[2] Max peak reflow temperature of 260 °C

Pin Descriptions

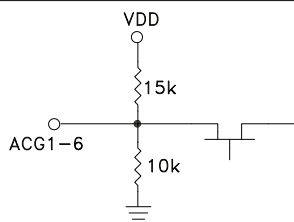
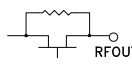
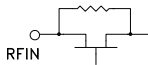
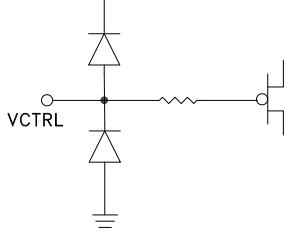
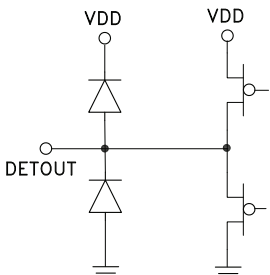
Pin Number	Function	Description	Interface Schematic
1, 3, 5-6, 28, 30	ACG1, ACG4, ACG5, ACG6, ACG3, ACG2	AC ground capacitance connection pin.	
2, 29	ATTN2OUT, ATTN1OUT	These ports are matched to 50 Ohms. Blocking capacitor is required.	
4, 9, 31	VDD	Power supply for the attenuator. External by pass capacitors are required. See application circuit.	
7, 32	ATTN2IN, ATTN1IN	These ports are matched to 50 Ohms. Blocking capacitor is required.	
8	VCTRL	Attenuation control voltage for the attenuator. 0V for minimum attenuation, 5V for maximum attenuation.	
10, 11, 26	N/C	No connection required. These pins may be connected to RF ground without affecting performance.	
12	CT1	Reserved pin and should be connected to ground.	
13	DETOUT	Logarithmic output that converts the input power to a DC level in controller mode. Output voltage increases with increasing amplitude.	

**IF AUTOMATIC GAIN CONTROLLER
(IF-AGC), 50 - 800 MHz**
Pin Descriptions (continued)

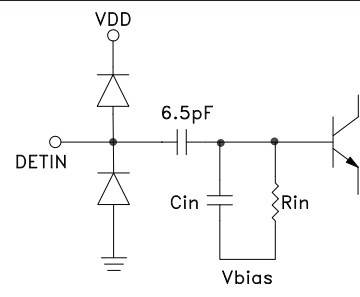
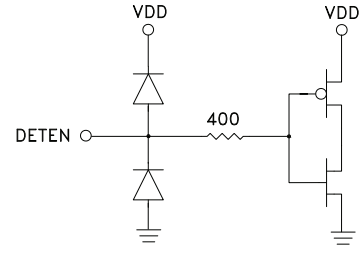
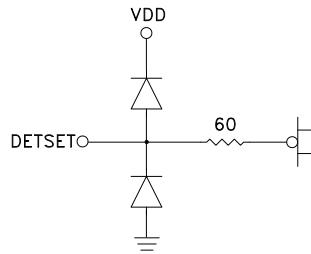
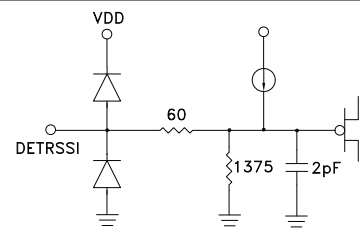
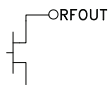
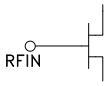
Pin Number	Function	Description	Interface Schematic
14	DETVDD	Power supply for the attenuator. External by pass capacitors are required. See application circuit.	
15, 17, 22, 24	GND	These pins must be connected to RF ground.	
16	DETIN	Detector RF input pin.	
18	DETEN	Enable pin. Apply VEN > 0.8xVcc for normal operation. Apply VEN < 0.2xVcc to disable the detector.	
19	DETSET	Set point input for controller mode. Connect to DETOUT with the resistor network shown in evaluation board drawing for detector mode.	
20	DETRSSI	Connection for ground referenced external lowpass filter capacitor.	
21, 25	AMP2OUT, AMP1OUT	These ports are mated to 50 Ohms. External Choke inductor and DC blocking capacitor are required. See application circuit.	
23, 27	AMP2IN, AMP1IN	These ports are matched to 50 Ohms. Blocking capacitor is required.	

Application Circuit

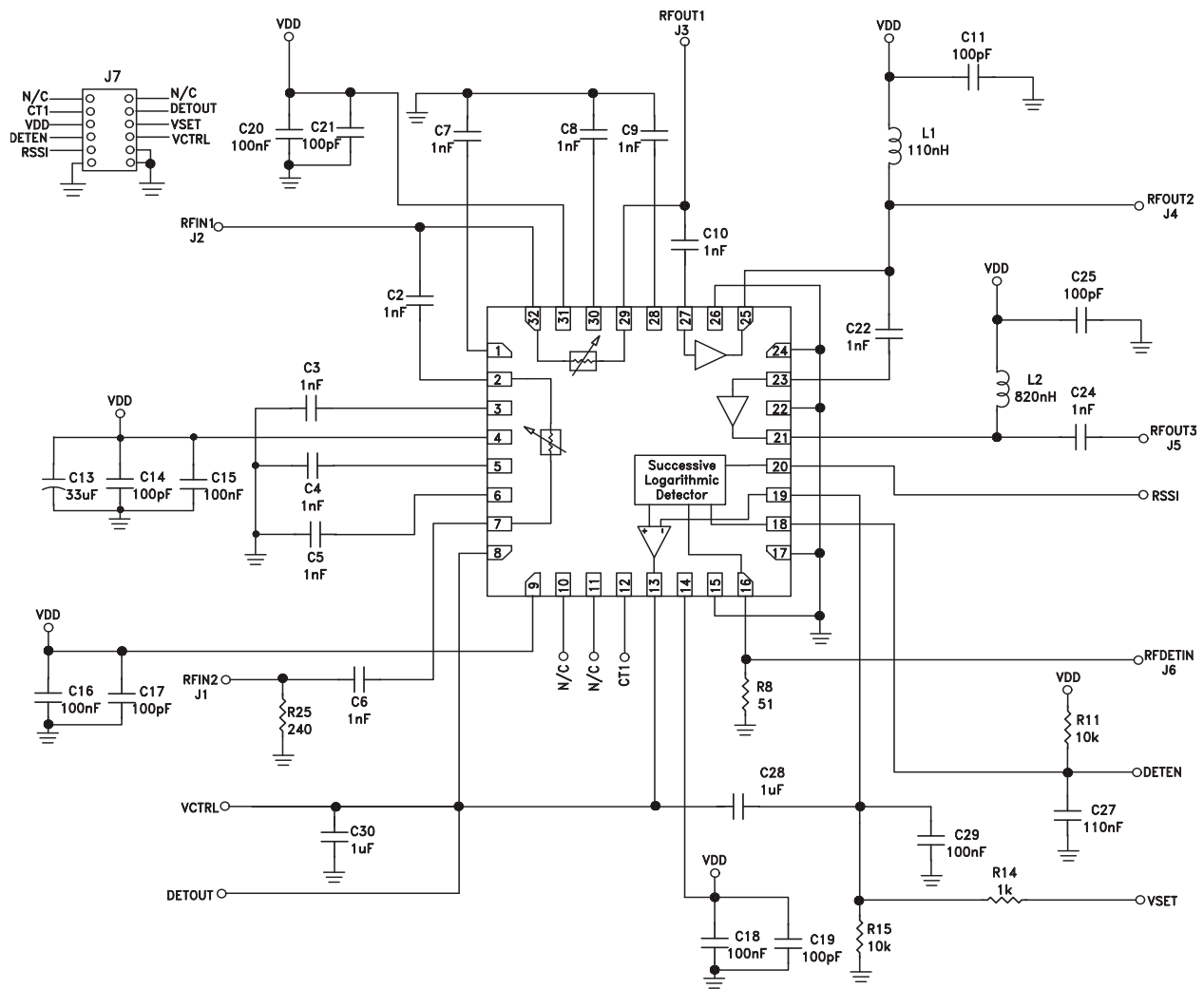

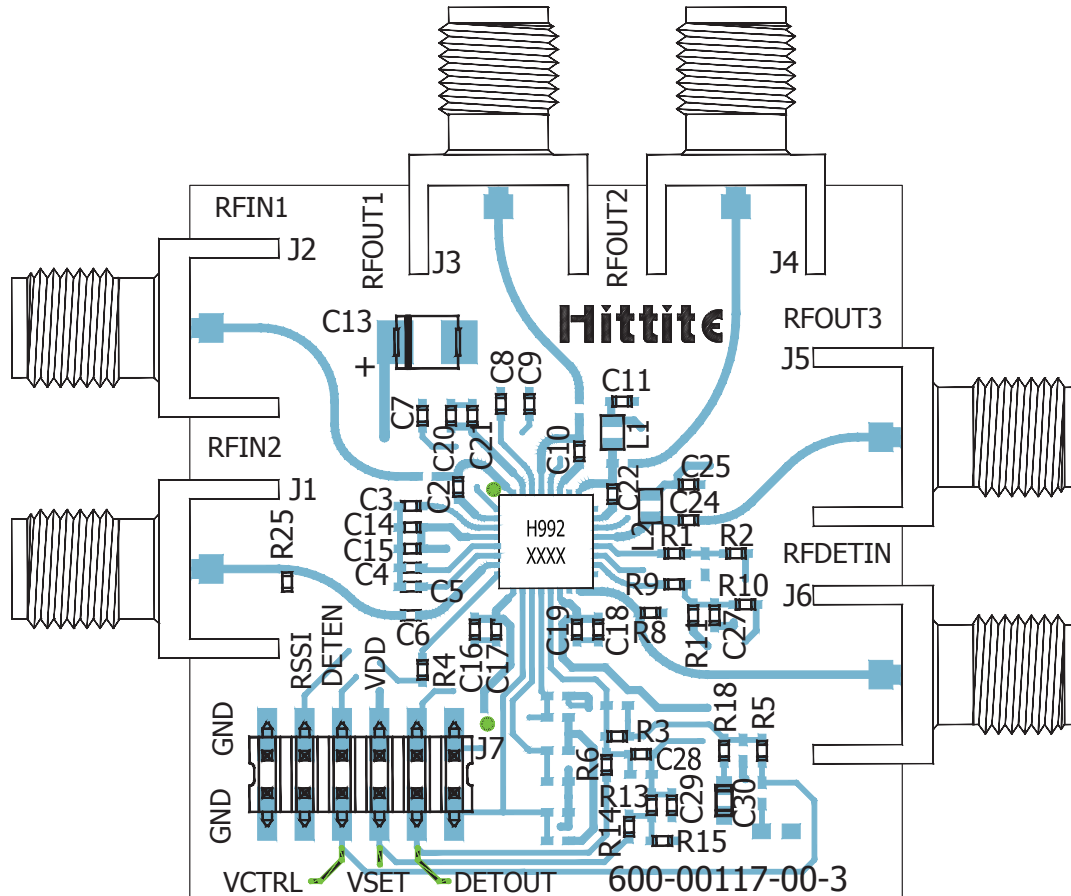
Evaluation PCB

List of Materials for Evaluation PCB EVAL01-HMC992LP5E^[1]

Item	Description
J1-J6	SMA Connector
J7	DC Connector Header
C2-C10, C22, C24	1 nF Capacitor, 0402 Pkg.
C11, C14, C17, C19, C21, C25	100 pF Capacitor, 0402 Pkg.
C13	33 μ F Capacitor, Tantalum
C15-C16, C18, C20, C27, C29	0.1 μ F Capacitor, 0402 Pkg.
C30	1 μ F Capacitor, 0603 Pkg.
L1	110 nH Inductor, 0603 Pkg.
L2	820 nH Inductor, 0603 Pkg.
R1-R6, R9-R10, R13, R18	0 Ohm Resistor, 0402 Pkg.
R8	51 Ohms Resistor, 0402 Pkg.
R11, R15	10 kOhms Resistor, 0402 Pkg.
R14	1 kOhms Resistor, 0402 Pkg.
R25	240 Ohms Resistor, 0402 Pkg.

Item	Description
U1	HMC992LP5E IF-Automatic Gain Controller
PCB [2]	600-00117-00 Evaluation PCB

[1] Reference this number when ordering complete evaluation PCB

[2] Circuit Board Material: Rogers 4350 or Arlon 25 FR

Application Information

Introduction

The HMC992LP5E is a complete high performance Automatic Gain Control (AGC) solution, housing a Variable Gain Amplifier (VGA) core and a control core in a single package. Its unique VVA technology provides constant OIP3 over the entire control voltage range. The HMC992LP5E greatly simplifies the design of gain control loops by increasing the integration level and reducing the number of required circuit elements. The VGA core of the HMC992LP5E is composed of two identical voltage variable attenuators followed by two gain block amplifiers which operate from 10 to 800 MHz. The HMC992LP5E's control core features a high accuracy log detector. As shown in the functional block diagram, the HMC992LP5E combines all of these cores in a highly compact 5 x 5 mm plastic package, and offers an easy-to-use, temperature stable AGC solution.

The HMC992LP5E's VGA core has a flexible structure where a single attenuator (23dB) or two attenuators (46dB) can be used depending upon the dynamic range requirement. The HMC992LP5E is designed to operate in a 50 Ohms impedance system. Inputs and outputs of the HMC992LP5E's attenuators and amplifiers (ATTIN1, ATTOUT1, ATTIN2, ATTOUT2, AMPIN1, AMPOUT1, AMPIN2, AMPOUT2) are broadband matched to 50 Ohms single-ended and require only external DC blocking capacitors over the entire frequency band of operation. The input of the HMC992LP5E's built in log detector (RFDETIN) is also broadband matched to 50 Ohms with a single-ended input interface and does not require any matching components.

The HMC992LP5E requires a single 5V supply with adequate power supply decoupling as recommended in the application schematic.

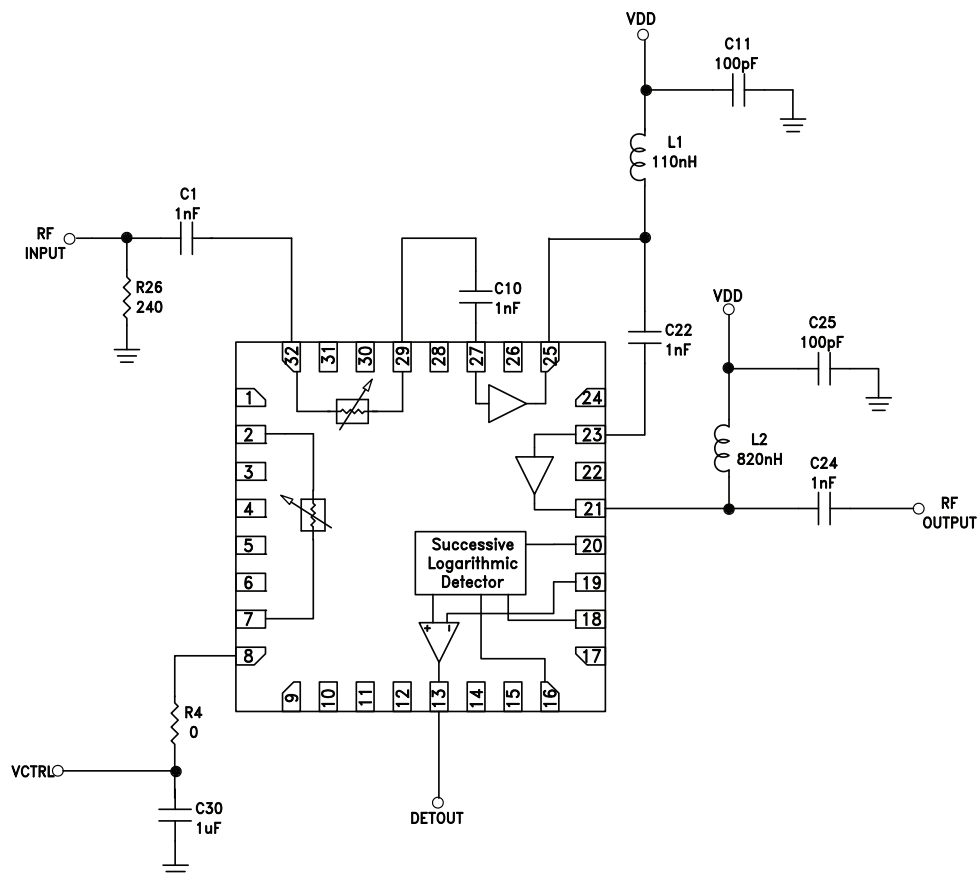

Figure 1a: The HMC992LP5E's VGA configuration with 1 attenuator.

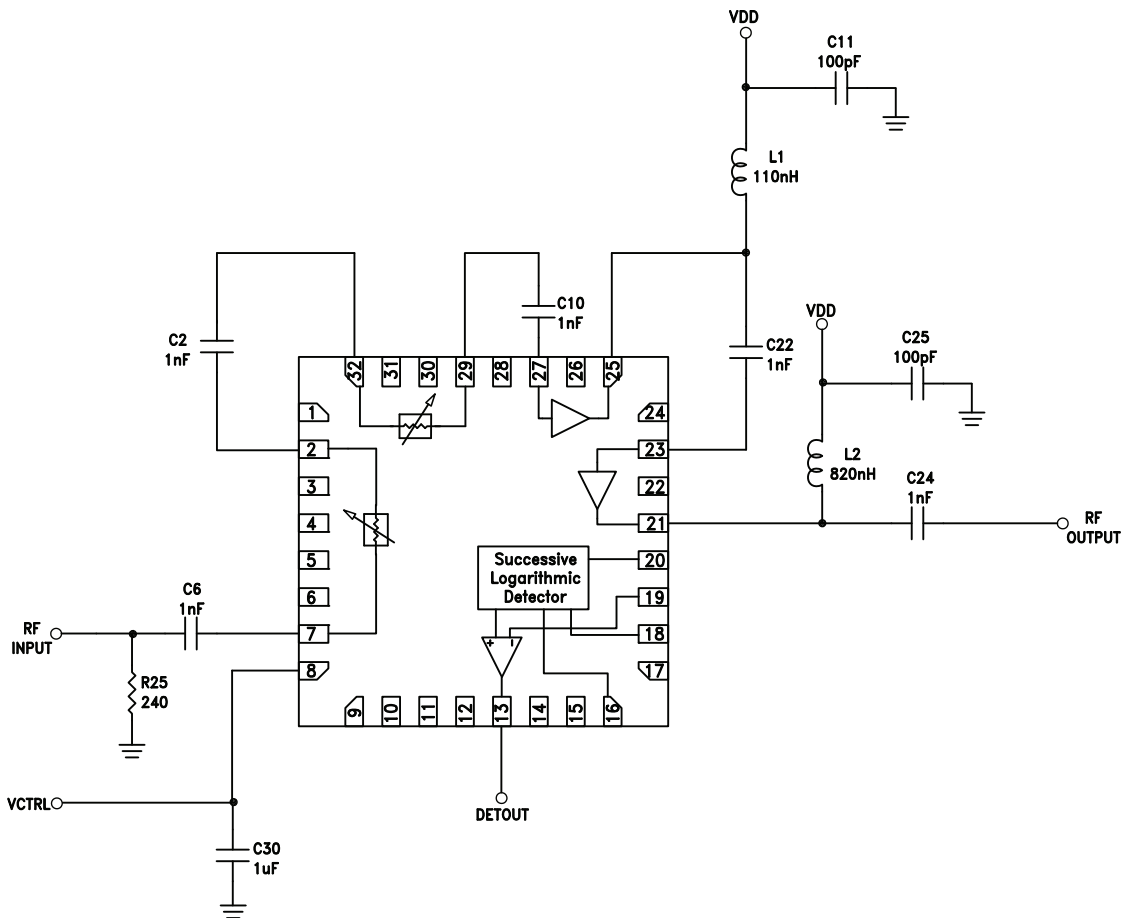

Figure 1b: The HMC992LP5E's VGA configuration with 2 attenuators.

VGA Operation

The HMC992LP5E's VGA core can be configured with one or two variable attenuators followed by two fixed gain amplifiers for different control ranges as shown in Figure 1a and Figure 1b (basic connections are not shown). The blocks require only external DC blocking capacitors at their inputs and outputs for interconnections. Note that the link between VCTRL and DETOUT pins must be broken for correct VGA Operation. The VCTRL pin should be used to set the attenuation of the HMC992LP5E.

Gain Control Interface VCTRL

The VCTRL pin is the gain control pin common to both of HMC992LP5E's identical voltage variable attenuators. The VCTRL gain control voltage ranges between 1V and 4V. A VCTRL control voltage of 1V provides the lowest attenuation, while 4V provides the highest attenuation.

Figure 2 represents the VGA operation of HMC992LP5E with two attenuators and two amplifiers for different gain control voltages applied to the VCTRL pin. The output power increases linearly with the input power until the power saturation is reached when the VCTRL voltage is constant. The useable input power range of such a system is limited by the saturation level of the final stage amplifier. So the input power level required for power saturation and the dynamic range of the



IF AUTOMATIC GAIN CONTROLLER (IF-AGC), 50 - 800 MHz

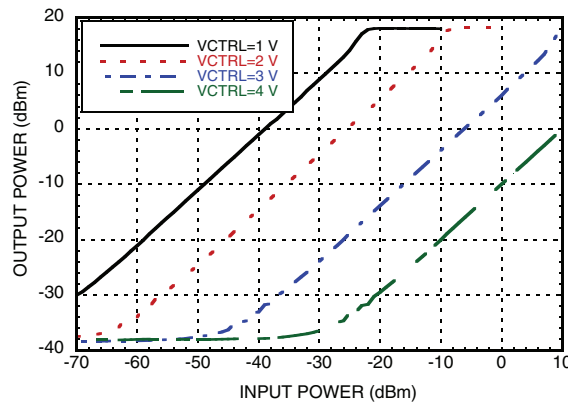

Figure 2: Pout vs. Pin at 100 MHz, 1 attenuator

HMC992LP5E's VGA is defined by the value of the gain control voltage applied to the VCTRL pin. Refer to the Figure 2 for the useable input power range at different VCTRL levels.

When VCTRL=1V, the gain of HMC992LP5E's VGA with 2 attenuators is 39 dB at 100 MHz. The input power required for 1 dB compression point at the output is given by: $P_{in1dB} = P_{out1dB} - \text{Gain (dB)} = 18 - 39 = -21 \text{ dB}$.

When VCTRL=2V, the gain of the HMC992LP5E's VGA with 2 attenuators is 25 dB at 100 MHz. The input power required for 1 dB compression point at the output is given by: $P_{in1dB} = P_{out1dB} - \text{Gain (dB)} = 18 - 25 = -7 \text{ dB}$.

Therefore, increasing the VCTRL pin voltage reduces the gain of the HMC992LP5E's VGA and increases input power level required for power saturation. When the input signal is weak, the attenuation level of the variable attenuators should be reduced. When the input signal is large; the attenuation level of the variable attenuators should be increased to achieve a constant output level.

The gain control performance of the HMC992LP5E at 300 MHz is shown in Figures 3a and 3b. The HMC992LP5E provides 24 dB of gain control range with a maximum gain of 41.2 dB when it is configured in 1 attenuator + 2 amplifiers mode, and similarly a 48 dB of gain control range with a maximum gain of 39 dB of gain when it is configured in 2 attenuators + 2 amplifiers mode. The HMC992LP5E's VGA has a very flat linear-in-dB gain control characteristic with a slope of -18.2 dB/V for the 2 attenuator configuration and -9.1 dB/V for the 1 attenuator configuration. The log-linearity error of the HMC992LP5 VGA is typically less than $\pm 1 \text{ dB}$ over the entire gain control range as shown in Figure 3a and Figure 3b. The relation between the gain of HMC992LP5E's VGA and VCTRL pin voltage can be approximated as given in Equation (1).

$$\text{Gain (dB)} = 52.5 - 9.1 \times \text{VCTRL with one attenuator} \quad \text{Equation (1a)}$$

$$\text{Gain (dB)} = 61.0 - 18.2 \times \text{VCTRL with two attenuators} \quad \text{Equation (1b)}$$

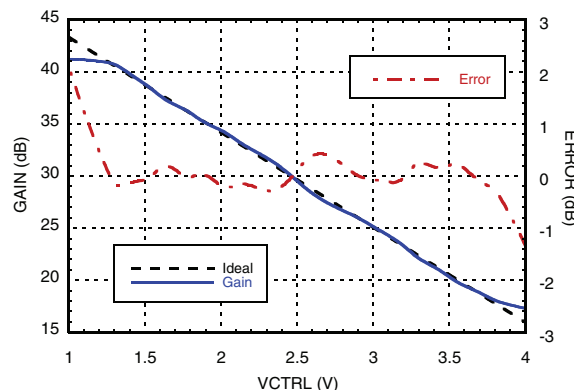

Figure 3a: Gain & Gain Conformance Error vs. VCTRL at 300 MHz, 1 attenuator + 2 amplifiers configuration.



IF AUTOMATIC GAIN CONTROLLER (IF-AGC), 50 - 800 MHz

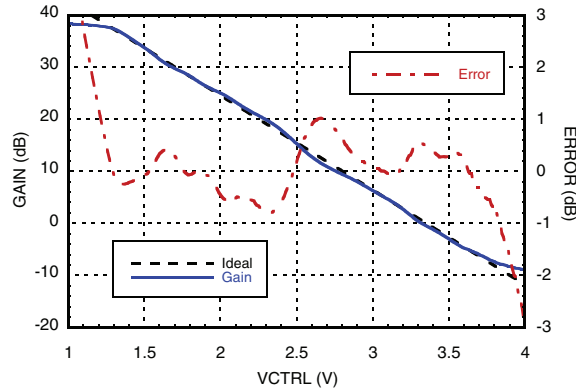

Figure 3b: Gain & Gain Conformance Error vs. VCTRL at 300 MHz, 2 attenuators + 2 amplifiers configuration.

Noise and Distortion

As with any multistage VGA consisting of voltage variable attenuators and gain blocks, the noise figure (NF) and input referred distortion (IIP3) characteristics of the HMC992LP5E's VGA are dependent on the gain control voltage VCTRL. When the attenuation level of the variable attenuators is set to minimum (maximum gain state), the noise figure of the HMC992LP5E's VGA is minimized; however the IIP3 is degraded to minimum as well. The noise figure and IIP3 of the HMC992LP5E's VGA increases with the attenuation level of the variable attenuators.

For low attenuation levels, the noise contribution from the VGA is important since the input signal is weak. For high attenuation levels of the variable attenuators, the noise contribution from the VGA is less important and the noise requirement of the VGA is relaxed since the input signal is high. The noise figure performance of the HMC992LP5E's VGA at 300 MHz is shown in Figure 4. The HMC992LP5E's VGA delivers a noise figure of 6 dB in its maximum gain state when it is configured in 1 attenuator + 2 amplifiers mode.

For low attenuation levels of the variable attenuators, IIP3 is less important since high gain of whole VGA improves distortion performance at its output (OIP3). For high attenuation levels of the variable attenuators, IIP3 is more important because of low gain of whole VGA. The distortion performance of the HMC992LP5E's VGA at 300 MHz is shown in Figure 4. The HMC992LP5E's VGA provides an almost constant OIP3 of up to +44 dBm in any state when it is configured in one attenuator and two amplifiers mode.

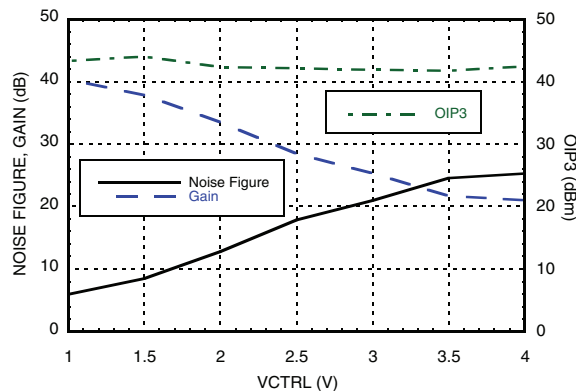

Figure 4: Noise Figure & Gain & OIP3 vs. VCTRL at 300 MHz, 1 attenuator.



IF AUTOMATIC GAIN CONTROLLER (IF-AGC), 50 - 800 MHz

AGC Operation

The HMC992LP5E can be configured as an AGC amplifier by using VGA core and the built in log detector. An example for AGC amplifier configuration of the HMC992LP5E is depicted in below figure.

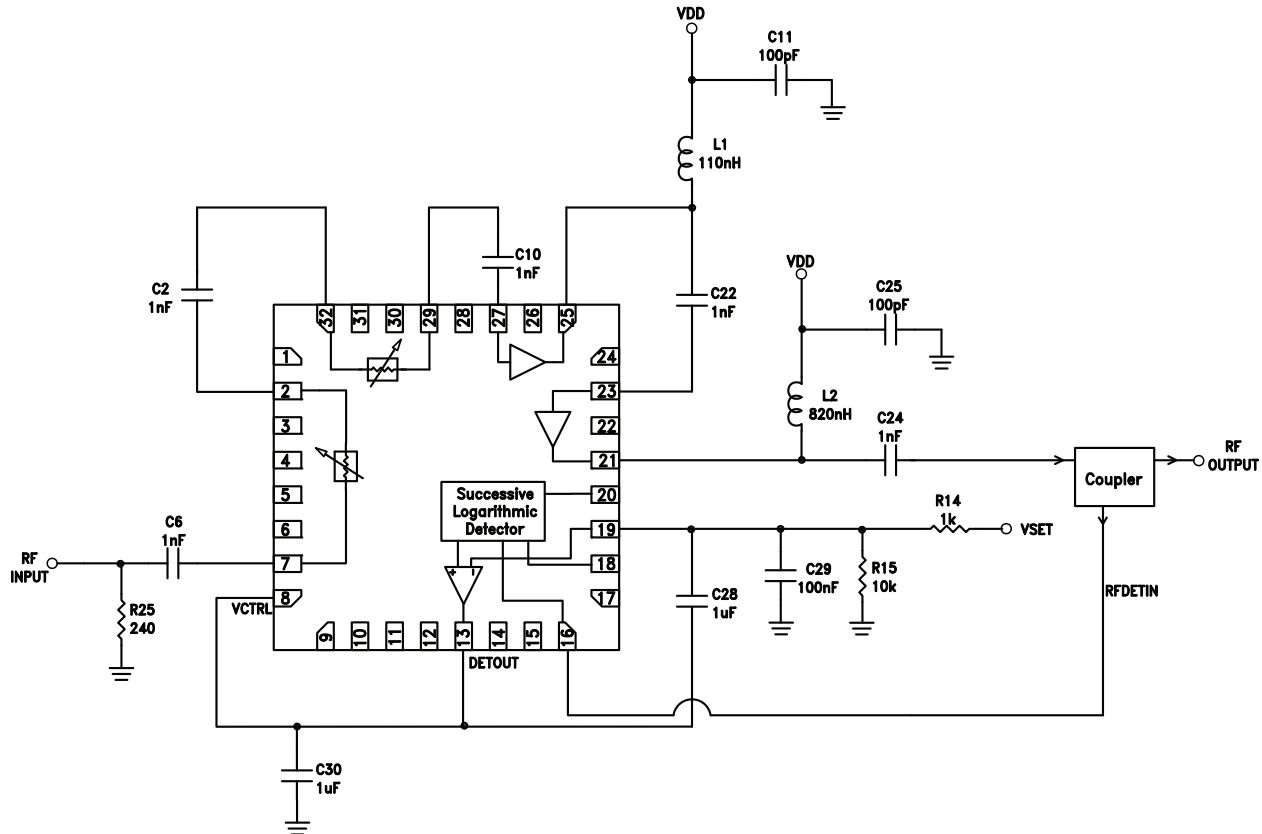

Figure 5: The HMC992LP5E's AGC configuration with 2 attenuators.

In AGC amplifier configuration, the input signal is amplified by the HMC992LP5E's VGA. The output of the HMC992LP5E's VGA core is fed back to the input of the HMC992LP5E's log detector (RFDETIN) through an external coupler or attenuator to drop the maximum and minimum output level of the HMC992LP5E's VGA to within the dynamic range of the HMC992LP5E's log detector. The HMC992LP5E's log detector produces a voltage at the output of the log detector (DETOUT) proportional to the output power level of the HMC992LP5E's VGA. The high impedance output pin DETOUT is connected to the gain control pin VCTRL of VGA to form the AGC loop. The VSET pin is the constant output power set point of the AGC amplifier. As a result of negative feedback, the gain of the VGA is automatically adjusted to maintain a constant signal power level at the output of AGC amplifier. The output signal power level is determined by the AGC set point VSET, regardless of the input signal variation.

AGC Set point Interface VSET

In closed loop AGC operation the output power level of the HMC992LP5E is controlled by the VSET pin. An input voltage between 0.2V and 1.2V should be applied to the VSET input pin to control the output power level. The VSET vs. the output power characteristic is shown in Figure 6a and Figure 6b for different input power levels and different coupler ratios used. The slope of the gain vs. VSET characteristic is 57dB/V and it is independent of the coupler ratio used.

In closed loop operation the HMC992LP5E is able to automatically adjust the RF gain over a gain adjustment range of up to 46 dB at 100 MHz. The HMC992LP5E's output dynamic range is a function of both input power level and the coupler ratio used to close the AGC loop. The combined effect of the input power and coupler ratio on the output power dynamic range is presented in Figures 6a and 6b.

For high input power levels, the maximum level of output dynamic range is limited by the Psat of the VGA or the highest detectable power level by the log detector. To eliminate any limitations that can arise due to highest detectable log detector, a high enough coupler ratio should be chosen to translate the maximum VGA output power level to a value lower than the highest detectable log detector power level.

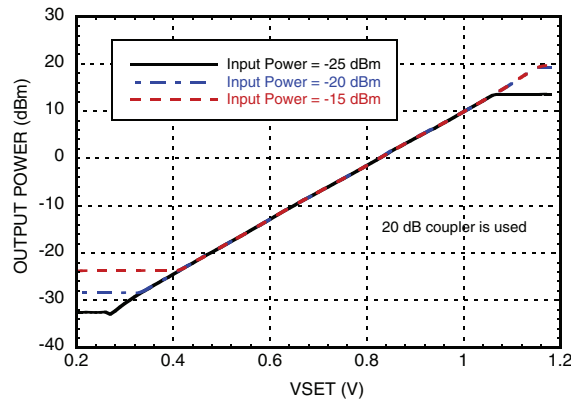

Figure 6a: Output Power vs. VSET over Input Power, 2 attenuators @ 300 MHz.

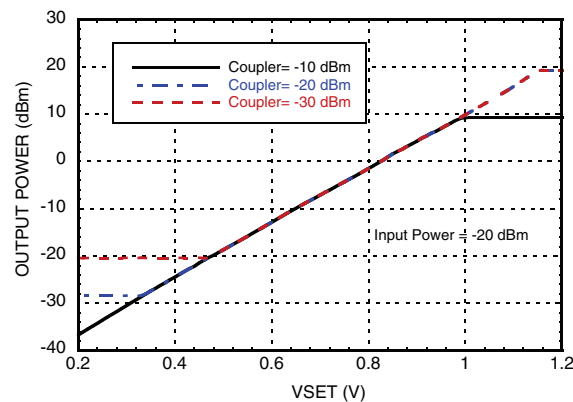

Figure 6b: Output Power vs. VSET over coupler ratio, 2 attenuators @ 300 MHz.

IF AUTOMATIC GAIN CONTROLLER (IF-AGC), 50 - 800 MHz

Similarly, the lower side of the dynamic range is limited by the noise floor of the VGA or the lowest power level detectable by the log detector. To eliminate any limitations on the lower side of the dynamic range, the coupler ratio should be low enough to translate the minimum VGA output power level to a value higher than the lowest detectable log detector power level.

Please also refer to the Log Detector section for more information.

Figure 7a shows the output power vs. input power transfer characteristic of the HMC992LP5E over different VSET voltages for a closed AGC loop configuration. For low and high input power levels the HMC992LP5E attenuation range is saturated and the output is a linear function of the input. For input power levels within the dynamic range, the HMC992LP5E automatically adjusts the attenuation level as shown in Figure 7c to maintain a constant output power level. When Vset=0.6 V, the output power level is set to -13 dBm and the HMC992LP5E's AGC amplifier provides a gain control range of 46 dB from -51 dBm to -5 dBm with an excellent ripple within 0.06 dB.

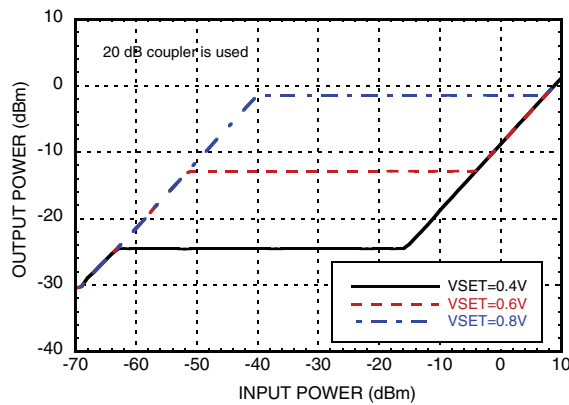

Figure 7a: Output Power vs. input power over VSET, 2 attenuators @ 300 MHz.

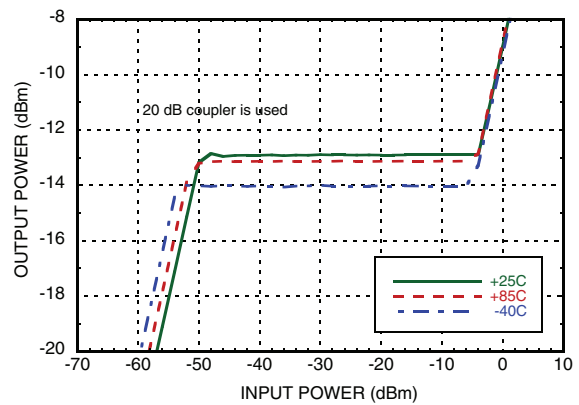

Figure 7b: Output Power vs. input power, 2 attenuators @ 400 MHz & VSET=0.6V

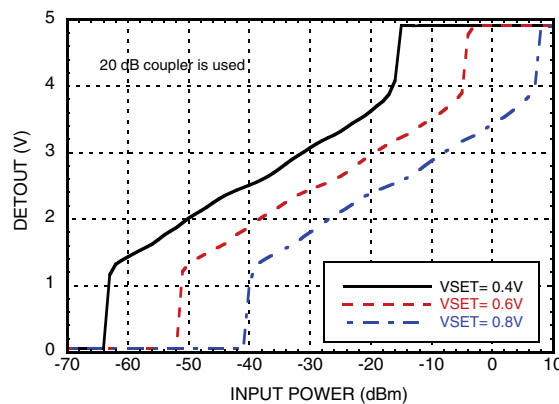

Figure 7c: DETOUT vs. input power over VSET, 2 attenuators @ 300 MHz.



Log Detector

The logarithmic detector of the HMC992LP5E converts the average envelope of RF input power to a proportional DC voltage at its output (DETOUT), as shown in Figure 8. In detection mode, the DETOUT pin should be connected to the VSET input. The HMC992LP5E's logarithmic detector employs a successive compression technology which delivers 50 dB of dynamic range (± 1 dB) with high conversion accuracy over a wide input frequency range. Note that the link between DETOUT and VCTRL pins must be broken and DETOUT must be connected to VSET via 1k Ohms resistor for LOGAMP operation.

The HMC992LP5E's logarithmic detector can be used in the controller mode where an external voltage is applied to the VSET pin to create an AGC loop. The linear-in-dB behavior of the HMC992LP5E's VGA and logarithmic detector creates a linear AGC system. For linear operation, the signal fluctuations at the input of the log detector should remain within the dynamic range of the log detector. In closed loop AGC operation, the HMC992LP5E's response to large input level changes is not slew-rate limited, and the speed of the transient response can be adjusted through loop filter capacitors C28 and C30 (see Figure 5).

To achieve maximum gain adjustment range of the HMC992LP5E, the coupler ratio should be chosen based on the output power desired. A coupler ratio which translates the output power to the center (-25dBm) of the usable dynamic range of the log detector should be chosen. The gain adjustment range of the HMC992LP5E is maximized in this configuration. If the linear operation range of the HMC992LP5E is maximized by selecting the appropriate coupler ratio, the HMC992LP5E can handle larger changes in input level. For example, an input voltage of 0.6 V is applied to the Vset pin to set the constant output power level to -13 dBm. A coupler ratio of ~ 12 dB can be chosen to provide a maximum dynamic range of 46 dBm.

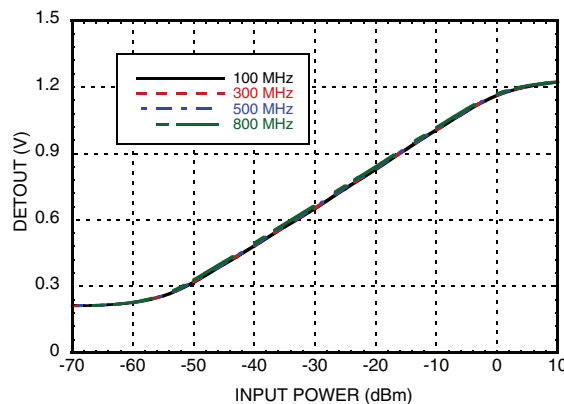

Figure 8: DETOUT vs. input power over frequency.

Loop Bandwidth and Response Time

The AGC system has a response time to undesired input level fluctuations. Response time and the stability of the HMC992LP5E's AGC loop is determined by C28 and C30 in the application schematic. The HMC992LP5E's response to voltage changes in VSET with C28=C30=1 μ F when the input level is kept constant is shown in Figure 9.

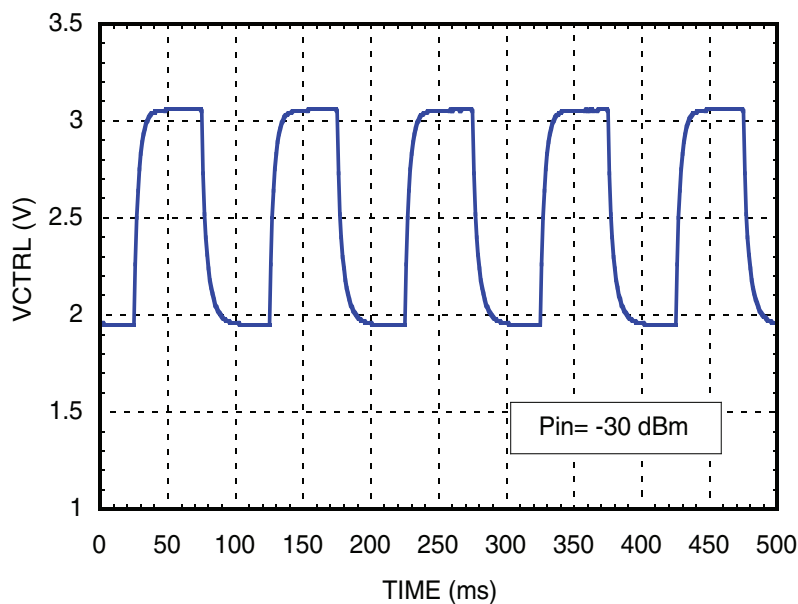

Figure 9: HMC992LP5E's gain control voltage when VSET is toggled between 0.4V - 0.8V and input level is kept constant in closed loop.



Компания «ЭлектроПласт» предлагает заключение долгосрочных отношений при поставках импортных электронных компонентов на взаимовыгодных условиях!

Наши преимущества:

- Оперативные поставки широкого спектра электронных компонентов отечественного и импортного производства напрямую от производителей и с крупнейших мировых складов;
- Поставка более 17-ти миллионов наименований электронных компонентов;
- Поставка сложных, дефицитных, либо снятых с производства позиций;
- Оперативные сроки поставки под заказ (от 5 рабочих дней);
- Экспресс доставка в любую точку России;
- Техническая поддержка проекта, помощь в подборе аналогов, поставка прототипов;
- Система менеджмента качества сертифицирована по Международному стандарту ISO 9001;
- Лицензия ФСБ на осуществление работ с использованием сведений, составляющих государственную тайну;
- Поставка специализированных компонентов (Xilinx, Altera, Analog Devices, Intersil, Interpoint, Microsemi, Aeroflex, Peregrine, Syfer, Eurofarad, Texas Instrument, Miteq, Cobham, E2V, MA-COM, Hittite, Mini-Circuits, General Dynamics и др.);

Помимо этого, одним из направлений компании «ЭлектроПласт» является направление «Источники питания». Мы предлагаем Вам помощь Конструкторского отдела:

- Подбор оптимального решения, техническое обоснование при выборе компонента;
- Подбор аналогов;
- Консультации по применению компонента;
- Поставка образцов и прототипов;
- Техническая поддержка проекта;
- Защита от снятия компонента с производства.



Как с нами связаться

Телефон: 8 (812) 309 58 32 (многоканальный)

Факс: 8 (812) 320-02-42

Электронная почта: org@eplast1.ru

Адрес: 198099, г. Санкт-Петербург, ул. Калинина, дом 2, корпус 4, литера А.