

## FEATURES

- Differential or Single-Ended Gain Block:  $\pm 10$  (20dB)
- $-3$ dB Bandwidth: 35MHz
- Slew Rate: 500V/ $\mu$ s
- Low Cost
- Output Current:  $\pm 50$ mA
- Settling Time: 200ns to 0.1%
- CMRR at 10MHz: 45dB
- Differential Gain Error: 0.2%
- Differential Phase Error: 0.08°
- Input Amplitude Limiting
- Single 5V Operation
- Drives Cables Directly

## APPLICATIONS

- Line Receivers
- Video Signal Processing
- Gain Limiting
- Oscillators
- Tape and Disc Drive Systems

## DESCRIPTION

The LT<sup>®</sup>1194 is a video difference amplifier optimized for operation on  $\pm 5$ V and a single 5V supply. The amplifier has a fixed gain of 20dB and features adjustable input limiting to control tough overdrive applications. It has uncommitted high input impedance (+) and (-) inputs, and can be used in differential or single-ended configurations.

The LT1194's high slew rate 500V/ $\mu$ s, wide bandwidth 35MHz, and  $\pm 50$ mA output current make it ideal for driving cables directly. This versatile amplifier is easy to use for video or applications requiring speed, accuracy and low cost.

The LT1194 is available in 8-pin PDIP and SO packages.

LT, LTC and LT are registered trademarks of Linear Technology Corporation.

## TYPICAL APPLICATION

Wideband Differential Amplifier  
with Limiting

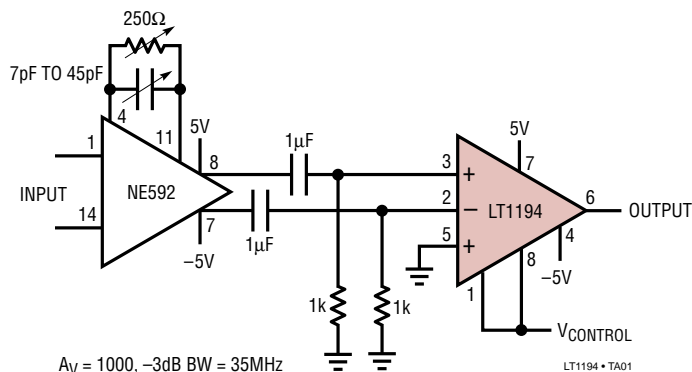

Sine Wave Reduced by Limiting

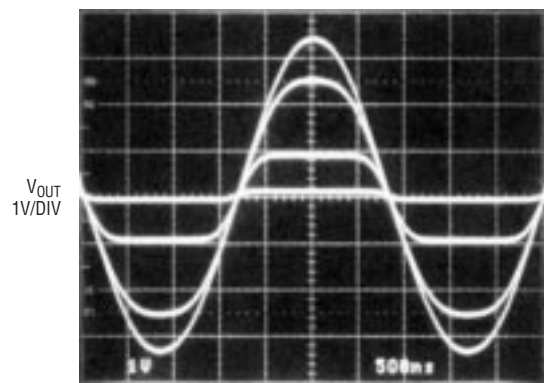

200kHz SINE WAVE WITH  $V_{CONTROL} = -5V, -4V, -3V, -2V$

## ABSOLUTE MAXIMUM RATINGS

(Note 1)

Total Supply Voltage ( $V^+$ to $V^-$ ) .....	18V
Differential Input Voltage .....	$\pm 6V$
Input Voltage .....	$\pm V_S$
Output Short Circuit Duration (Note 2) .....	Continuous
Operating Temperature Range	
<b>LT1194M (OBSOLETE)</b> .....	<b>-55°C to 125°C</b>
LT1194C .....	0°C to 70°C
Maximum Junction Temperature .....	150°C
Storage Temperature Range .....	-65°C to 150°C
Lead Temperature (Soldering, 10 sec) .....	300°C

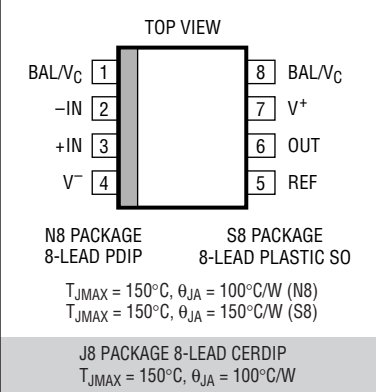
	ORDER PART NUMBER
	LT1194CN8 LT1194CS8
	S8 PART MARKING
	1194
	LT1194MJ8 LT1194CJ8
<b>OBSOLETE PACKAGE</b> Consider the N8 or S8 Packages for Alternate Source	

Consult LTC Marketing for parts specified with wider operating temperature ranges.

## ELECTRICAL CHARACTERISTICS

$V_S = \pm 5V$ ,  $V_{REF} = 0V$ , Null Pins 1 and 8 open circuit,  $T_A = 25^\circ C$ ,  $C_L \leq 10pF$ , unless otherwise noted.

SYMBOL	PARAMETER	CONDITIONS	LT1194M/C			UNITS	
			MIN	TYP	MAX		
$V_{OS}$	Input Offset Voltage	All Packages		1	6	mV	
$I_{OS}$	Input Offset Current			0.2	3	$\mu A$	
$I_B$	Input Bias Current			$\pm 0.5$	$\pm 3.5$	$\mu A$	
$e_n$	Input Noise Voltage	$f_0 = 10kHz$		15		$nV/\sqrt{Hz}$	
$i_n$	Input Noise Current	$f_0 = 10kHz$		4		$pA/\sqrt{Hz}$	
$R_{IN}$	Input Resistance	Either Input		30		$k\Omega$	
$C_{IN}$	Input Capacitance	Either Input		2		pF	
	Input Voltage Range		-2.5		3.5	V	
CMRR	Common Mode Rejection Ratio	$V_{CM} = -2.5V$ to $3.5V$	65	80		dB	
PSRR	Power Supply Rejection Ratio	$V_S = \pm 2.375V$ to $\pm 8V$	65	80		dB	
$V_{OMAX}$	Maximum Output Signal	$V_S = \pm 8V$ (Note 3)	$\pm 3$	$\pm 4.3$		V	
$V_{LIM}$	Output Voltage Limit	$V_I = \pm 0.5V$ , $V_C = 2V$ (Note 4)		$\pm 20$	$\pm 120$	mV	
$V_{OUT}$	Output Voltage Swing	$V_S = \pm 8V$ , $V_{REF} = 4V$	$R_L = 1k$	6.6	6.9	V	
			$R_L = 100\Omega$	6.3	6.7	V	
		$V_S = \pm 8V$ , $V_{REF} = -4V$	$R_L = 1k$	-6.7	-7.4	V	
			$R_L = 100\Omega$	-6.4	-6.7	V	
		$V_S = \pm 5V$ , $V_{REF} = 0V$ , $R_L = 1k$	$\pm 3$	$\pm 4$	V		
$G_E$	Gain Error	$V_0 = \pm 3V$	$R_L = 1k$		0.5	3	%
			$R_L = 100\Omega$		0.5	3	%
SR	Slew Rate	$V_0 = \pm 1V$ , $R_L = 1k$ (Notes 5, 9)	350	500		$V/\mu s$	
FPBW	Full-Power Bandwidth	$V_0 = 6V_{P-P}$ (Note 6)	18.5	26.5		MHz	
BW	Small-Signal Bandwidth			35		MHz	
$t_r$ , $t_f$	Rise Time, Fall Time	$R_L = 1k$ , $V_0 = \pm 500mV$ , 20% to 80% (Note 9)	4	6	8	ns	
$t_{PD}$	Propagation Delay	$R_L = 1k$ , $V_0 = \pm 125mV$ , 50% to 50%		6.5		ns	

## ELECTRICAL CHARACTERISTICS

$V_S = \pm 5V$ ,  $V_{REF} = 0V$ , Null Pins 1 and 8 open circuit,  $T_A = 25^\circ C$ ,  $C_L \leq 10pF$ , unless otherwise noted.

SYMBOL	PARAMETER	CONDITIONS	LT1194M/C			UNITS
			MIN	TYP	MAX	
	Overshoot	$V_O = \pm 125mV$		0		%
$t_s$	Settling Time	3V Step, 0.1% (Note 7)		200		ns
Diff $A_y$	Differential Gain	$R_L = 150\Omega$ (Note 8)		0.2		%
Diff Ph	Differential Phase	$R_L = 150\Omega$ (Note 8)		0.08		Deg <sub>p-p</sub>
$I_S$	Supply Current			35	43	mA

$V_S^+ = 5V$ ,  $V_S^- = 0V$ ,  $V_{REF} = 2.5V$ , Null Pins 1 and 8 open circuit,  $T_A = 25^\circ C$ ,  $C_L \leq 10pF$ , unless otherwise noted.

SYMBOL	PARAMETER	CONDITIONS	LT1194M/C			UNITS
			MIN	TYP	MAX	
$V_{OS}$	Input Offset Voltage	All Packages		2	8	mV
$I_{OS}$	Input Offset Current			0.2	3	$\mu A$
$I_B$	Input Bias Current			$\pm 0.5$	$\pm 3$	$\mu A$
	Input Voltage Range		2		3.5	V
CMRR	Common Mode Rejection Ratio	$V_{CM} = 2V$ to 3.5V	55	70		dB
$V_{LIM}$	Output Voltage Limit	$V_I = \pm 0.5V$ , $V_C = 2V$ (Note 4)		$\pm 20$	$\pm 120$	mV
$V_{OUT}$	Output Voltage Swing	$R_L = 100\Omega$ to Ground	$V_{OUT}$ High	3.6	3.8	V
			$V_{OUT}$ Low		0.25	0.4
SR	Slew Rate	$V_O = 1V$ to 3V		250		V/ $\mu s$
BW	Small-Signal Bandwidth			32		MHz
$I_S$	Supply Current			32	40	mA

The ● denotes specifications which apply over the full operating temperature range of  $-55^\circ C \leq T_A \leq 125^\circ C$ .

$V_S = \pm 5V$ ,  $V_{REF} = 0V$ , Null Pins 1 and 8 open circuit, unless otherwise noted.

SYMBOL	PARAMETER	CONDITIONS		LT1194M			UNITS
				MIN	TYP	MAX	
$V_{OS}$	Input Offset Voltage	N8 Package	●		1	9	mV
$\Delta V_{OS}/\Delta T$	Input $V_{OS}$ Drift		●		6		mV/ $^\circ C$
$I_{OS}$	Input Offset Current		●		0.8	5	$\mu A$
$I_B$	Input Bias Current		●		$\pm 1$	$\pm 5.5$	$\mu A$
	Input Voltage Range		●	-2.5		3.5	V
CMRR	Common Mode Rejection Ratio	$V_{CM} = -2.5V$ to 3.5V	●	58	80		dB
PSRR	Power Supply Rejection Ratio	$V_S = \pm 2.375V$ to $\pm 5V$	●	60	80		dB
$V_{LIM}$	Output Voltage Limit	$V_I = \pm 0.5V$ , $V_C = 2V$ (Note 4)	●		$\pm 20$	$\pm 150$	mV
$V_{OUT}$	Output Voltage Swing	$V_S = \pm 8V$ , $V_{REF} = 4V$	$R_L = 1k$	●	6	6.6	V
			$R_L = 100\Omega$	●	5.9	6.5	V
		$V_S = \pm 8V$ , $V_{REF} = -4V$	$R_L = 1k$	●	-6.1	-6.7	V
			$R_L = 100\Omega$	●	-6	-6.5	V
$G_E$	Gain Error	$V_O = \pm 3V$ , $R_L = 1k$	●		1	5	%
$I_S$	Supply Current		●		35	43	mA

**ELECTRICAL CHARACTERISTICS** The ● denotes specifications which apply over the full operating temperature range of  $0^{\circ}\text{C} \leq T_A \leq 70^{\circ}\text{C}$ .  $V_S = \pm 5\text{V}$ ,  $V_{\text{REF}} = 0\text{V}$ , Null Pins 1 and 8 open circuit, unless otherwise noted.

SYMBOL	PARAMETER	CONDITIONS	LT1194C			UNITS	
			MIN	TYP	MAX		
$V_{\text{OS}}$	Input Offset Voltage	All Packages	●	1	7	mV	
$\Delta V_{\text{OS}}/\Delta T$	Input $V_{\text{OS}}$ Drift		●	6		$\mu\text{V}/^{\circ}\text{C}$	
$I_{\text{OS}}$	Input Offset Current		●	0.2	3.5	$\mu\text{A}$	
$I_{\text{B}}$	Input Bias Current		●	$\pm 0.5$	$\pm 4$	$\mu\text{A}$	
	Input Voltage Range		●	-2.5	3.5	V	
CMRR	Common Mode Rejection Ratio	$V_{\text{CM}} = -2.5\text{V to } 3.5\text{V}$	●	60	80	dB	
PSRR	Power Supply Rejection Ratio	$V_S = \pm 2.375\text{V to } \pm 5\text{V}$	●	60	80	dB	
$V_{\text{LIM}}$	Output Voltage Limit	$V_I = \pm 0.5\text{V}$ , $V_C = 2\text{V}$ (Note 4)	●	$\pm 20$	$\pm 130$	mV	
$V_{\text{OUT}}$	Output Voltage Swing	$V_S = \pm 8\text{V}$ , $V_{\text{REF}} = 4\text{V}$	$R_L = 1\text{k}$	●	6.2	6.9	V
			$R_L = 100\Omega$	●	6.1	6.7	V
		$V_S = \pm 8\text{V}$ , $V_{\text{REF}} = -4\text{V}$	$R_L = 1\text{k}$	●	-6.4	-7.2	V
			$R_L = 100\Omega$	●	-6.2	-6.6	V
$G_E$	Gain Error	$V_O = \pm 3\text{V}$ , $R_L = 1\text{k}$	●	1	4	%	
$I_S$	Supply Current		●	35	43	mA	

**Note 1:** Absolute Maximum Ratings are those values beyond which the life of a device may be impaired.

**Note 2:** A heat sink is required to keep the junction temperature below absolute maximum when the output is shorted.

**Note 3:** There are two limitations on signal swing. Output swing is limited by clipping or saturation in the output stage. Input swing is controlled by an adjustable input limiting function. On  $V_S = \pm 5\text{V}$ , the overload characteristic is output limiting, but on  $\pm 8\text{V}$  the overload characteristic is input limiting.  $V_{\text{OMAX}}$  is measured with the null pins open circuit.

**Note 4:** Output amplitude is reduced by the input limiting function. The input limiting function occurs when the null pins, 1 and 8, are tied together and raised to a potential 0.3V or more above the negative supply.

**Note 5:** Slew rate is measured between  $\pm 1\text{V}$  on the output, with a  $\pm 0.3\text{V}$  input step.

**Note 6:** Full-power bandwidth is calculated from the slew rate measurement:

$$\text{FPBW} = \text{SR}/2\pi V_p$$

**Note 7:** Settling time measurement techniques are shown in "Take the Guesswork Out of Settling Time Measurements," EDN, September 19, 1985.

**Note 8:** NTSC (3.58MHz).

**Note 9:** AC parameters are 100% tested on the ceramic and plastic DIP packaged parts (J and N suffix) and are sample tested on every lot of the SO packaged part (S suffix).

**Optional Offset Nulling Circuit**

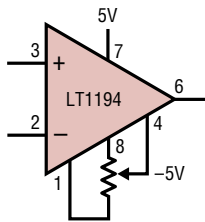

INPUT OFFSET VOLTAGE CAN BE ADJUSTED OVER A  $\pm 250\text{mV}$  RANGE WITH A  $1\text{k}\Omega$  TO  $10\text{k}\Omega$  POTENTIOMETER

**Input Limiting Connection**

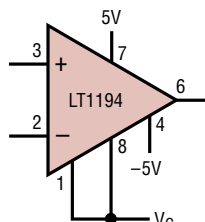

(NOTE 4)

**Input Limiting with Offset Nulling**

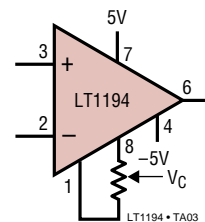

(NOTE 4)

# TYPICAL PERFORMANCE CHARACTERISTICS

**Input Bias Current vs Common Mode Voltage**

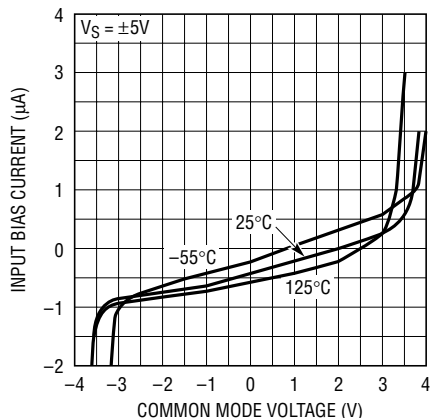

LT1194 • TPC01

**Input Bias Current vs Temperature**

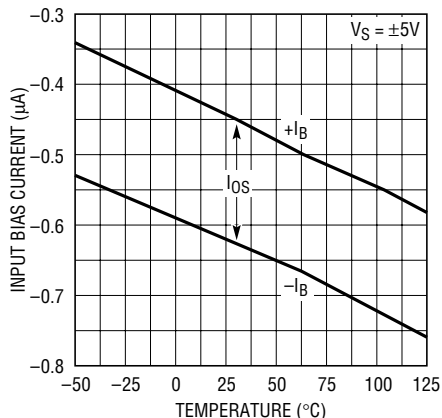

LT1194 • TPC02

**Common Mode Voltage vs Supply Voltage**

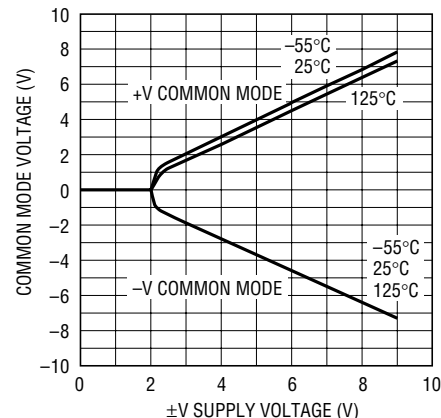

LT1194 • TPC03

**Equivalent Input Noise Voltage vs Frequency**

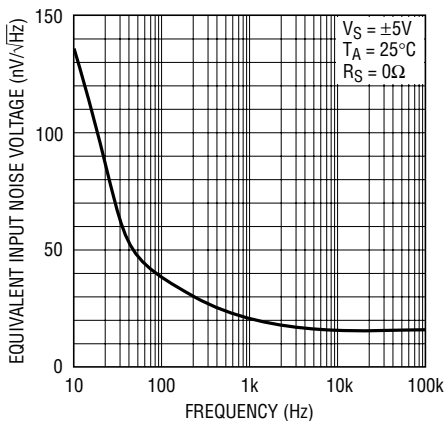

LT1194 • TPC04

**Equivalent Input Noise Current vs Frequency**

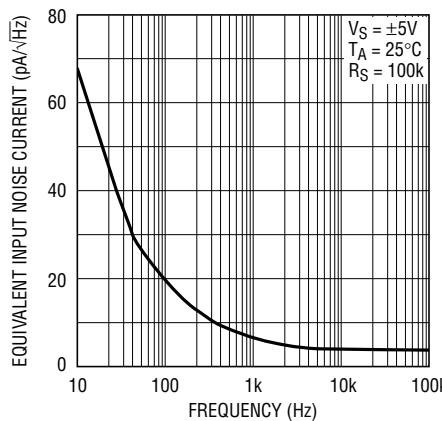

LT1194 • TPC05

**Supply Current vs Supply Voltage**

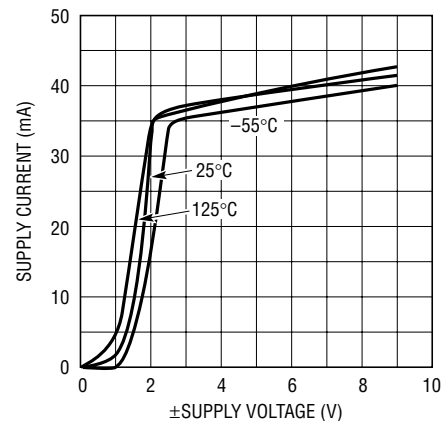

LT1194 • TPC06

**Gain, Phase vs Frequency**

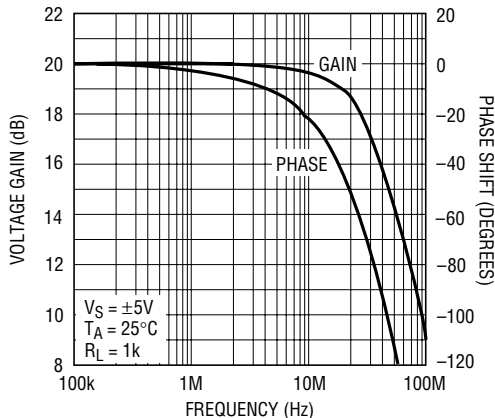

LT1194 • TPC08

**Gain Error vs Temperature**

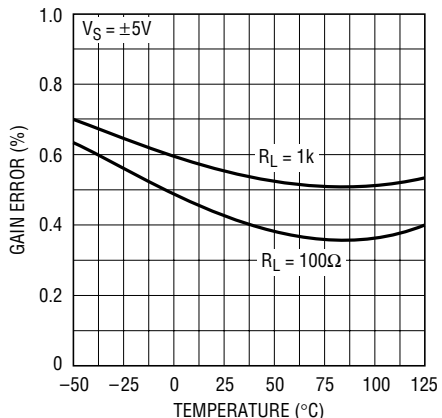

LT1194 • TPC07

**-3dB Bandwidth vs Supply Voltage**

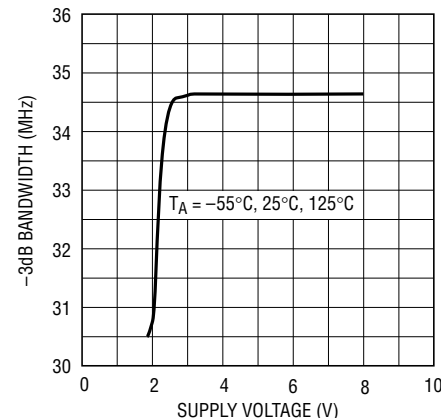

LT1194 • TPC09

# TYPICAL PERFORMANCE CHARACTERISTICS

**Output Impedance vs Frequency**

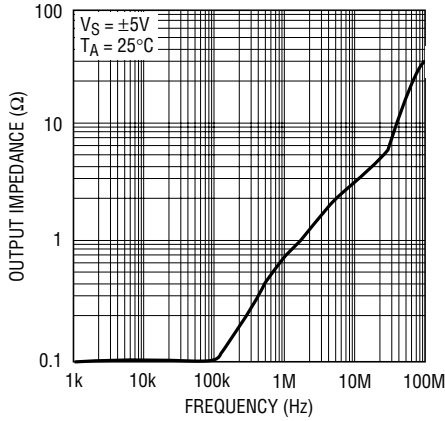

LT1194 • TPC10

**Common Mode Rejection Ratio vs Frequency (Output Referred)**

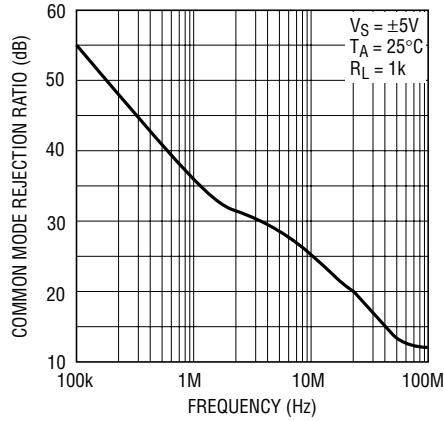

LT1194 • TPC11

**Power Supply Rejection Ratio vs Frequency (Output Referred)**

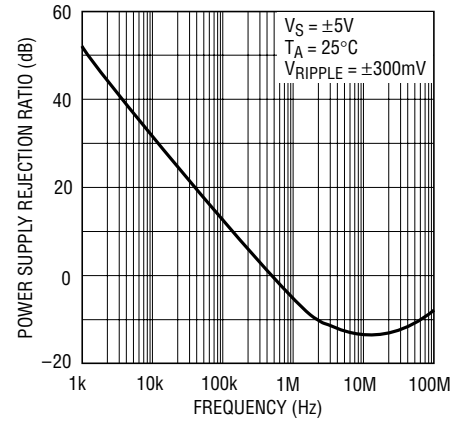

LT1194 • TPC12

**Output Short-Circuit Current vs Temperature**

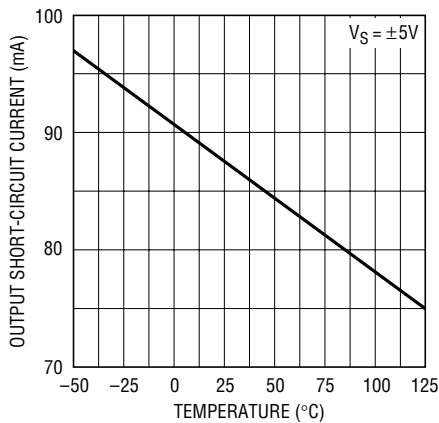

LT1194 • TPC13

**Output Voltage Limiting vs Supply Voltage**

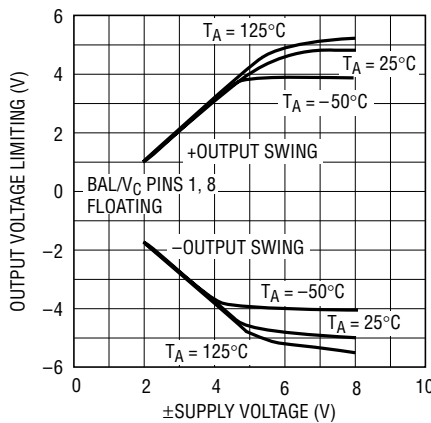

LT1194 • TPC14

**Output Voltage vs Voltage On Control Pins**

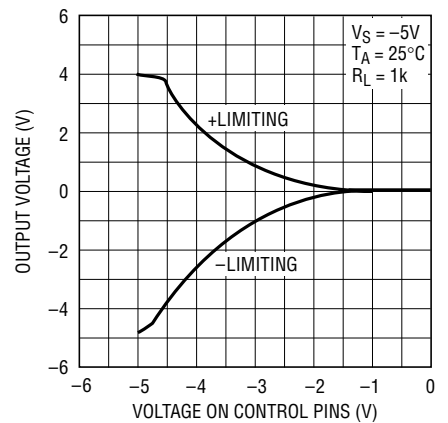

LT1194 • TPC15

**Voltage Gain vs Frequency with Control Voltage**

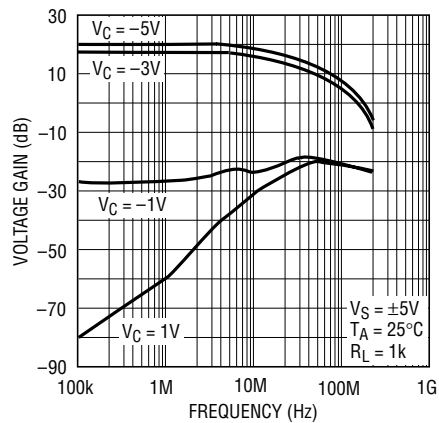

LT1194 • TPC16

**Output Voltage Swing vs Load Resistance**

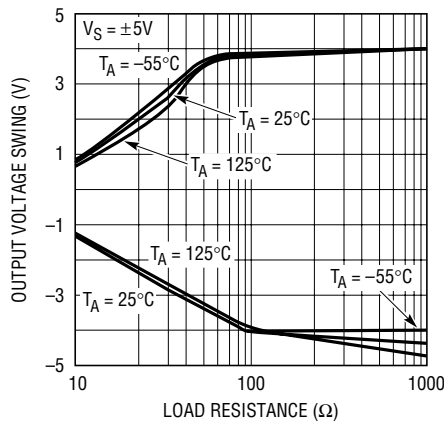

LT1194 • TPC17

**Slew Rate vs Temperature**

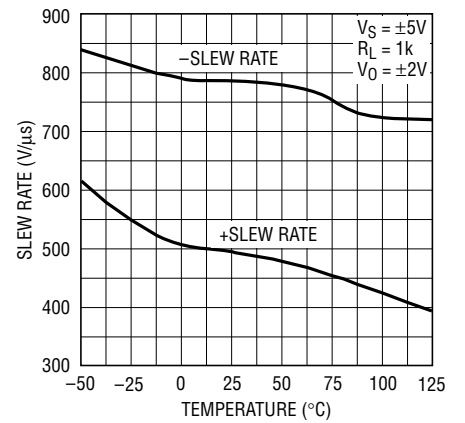

LT1194 • TPC18

## TYPICAL PERFORMANCE CHARACTERISTICS

**Output Voltage Step vs Settling Time**

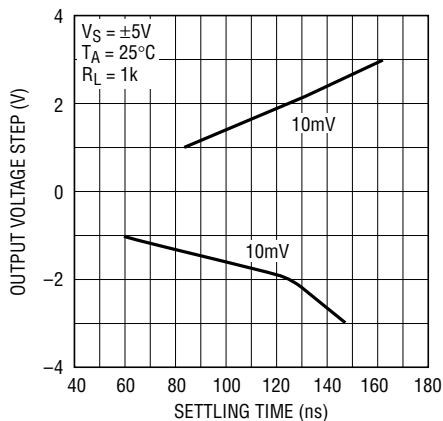

LT1194 • TPC19

**Small-Signal Transient Response**

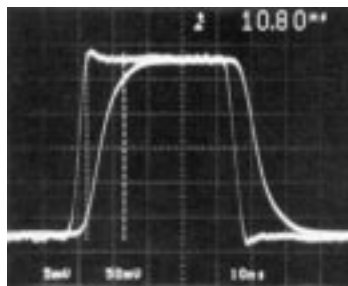

RISE TIME = 10.8ns, PROPAGATION DELAY = 6ns  
LT1194 • TPC20

**Large-Signal Transient Response**

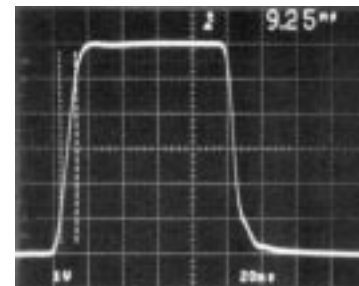

$R_L = 150\Omega$ , +SR = 430V/ $\mu$ s, -SR = 500V/ $\mu$ s  
LT1194 • TPC21

## APPLICATIONS INFORMATION

The LT1194 is a video difference amplifier with a fixed gain of 10 (20dB). The amplifier has two uncommitted high input impedance (+) and (-) inputs that can be used either differentially or single-ended. The LT1194 includes a limiting feature that allows the amplifier to reduce its output as a function of DC voltage on the BAL/ $V_C$  pins. The limiting feature uses input differential-pair limiting to prevent overload in subsequent stages. This technique allows extremely fast limiting action.

### Power Supply Bypassing

The LT1194 is quite tolerant of power supply bypassing. In some applications a 0.1 $\mu$ F ceramic disc capacitor placed 1/2 inch from the amplifier is all that is required.

**Input Limiting**

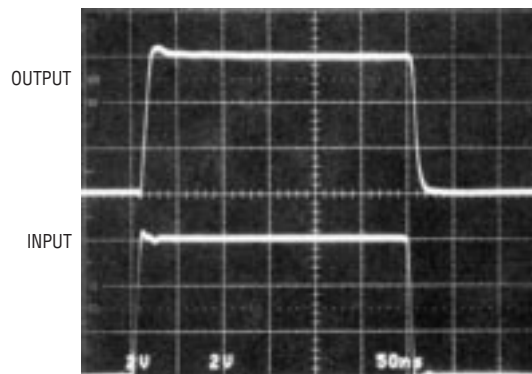

20dB INPUT OVERDRIVE,  $V_C = -4.2V$   
LT1194 • TA04

## APPLICATIONS INFORMATION

A scope photo of the amplifier output with no supply bypassing is used to demonstrate this bypassing tolerance,  $R_L = 1k$ .

In many applications, and those requiring good settling time, it is important to use multiple bypass capacitors. A  $0.1\mu F$  ceramic disc in parallel with a  $4.7\mu F$  tantalum is recommended. Two oscilloscope photos with different bypass conditions are used to illustrate the settling time characteristics of the amplifier. Note that although the output waveform looks acceptable at  $1V/DIV$ , when amplified to  $10mV/DIV$  the settling time to  $10mV$  is  $200ns$ . The time drops to  $162ns$  with multiple bypass capacitors, and does not exhibit the characteristic power supply ringing.

### No Supply Bypass

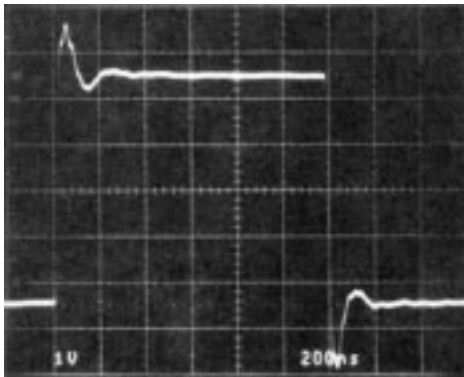

IN DEMO BOARD,  $R_L = 1k$

LT1194 • TA05

### Settling Time Poor Bypass

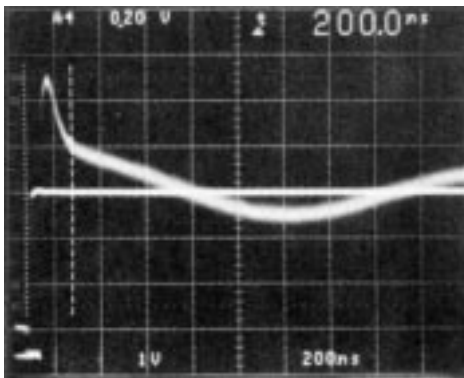

SETTLING TIME TO  $10mV$ ,  
SUPPLY BYPASS CAPACITORS =  $0.1\mu F$

LT1194 • TA06

### Settling Time Good Bypass

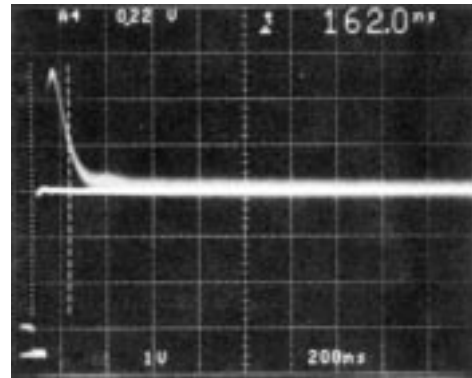

LT1194 • TA07

SETTLING TIME TO  $10mV$ ,  
SUPPLY BYPASS CAPACITORS =  $0.1\mu F + 4.7\mu F$  TANTALUM

## Cable Terminations

The LT1194 video difference amplifier has been optimized as a low cost cable driver. The  $\pm 50mA$  guaranteed output current enables the LT1194 to easily deliver  $7.5V_{P-P}$  into  $100\Omega$ , while operating on  $\pm 5V$  supplies, or  $2.6V_{P-P}$  on a single  $5V$  supply.

When driving a cable it is important to terminate the cable to avoid unwanted reflections. This can be done in one of two ways: single termination or double termination. With single termination, the cable must be terminated at the receiving end ( $75\Omega$  to ground) to absorb unwanted energy. The best performance can be obtained by double termination ( $75\Omega$  in series with the output of the amplifier, and  $75\Omega$  to ground at the other end of the cable). This termination is preferred because reflected energy is absorbed at each end of the cable. When using the double termination technique it is important to note that the signal is attenuated by a factor of 2, or 6dB. For a cable driver with a gain of 5 (LT1194 gain of 10), the  $-3dB$  bandwidth is over  $30MHz$  with no peaking.

## A Voltage Controlled Current Source

The LT1194 can be used to make a fast, precise, voltage controlled current source. The LT1194 high speed differential amplifier senses the current delivered to the load. The input signal  $V_{IN}$ , applied to the (+) input of the LT1194,



# APPLICATIONS INFORMATION

## Double Terminated Cable Driver

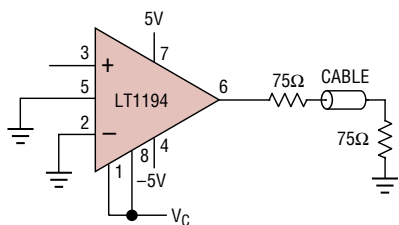

## Voltage Gain vs Frequency

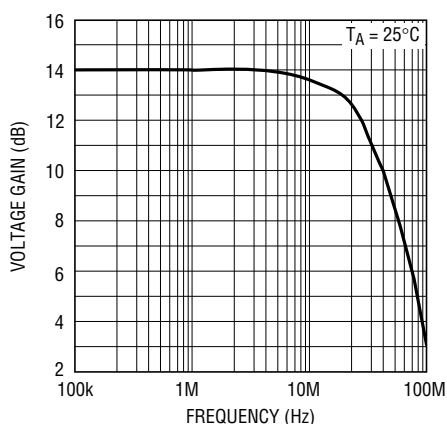

LT1194 • TA08

will appear at the (-) input if the feedback loop is properly closed. In steady state the input signal appears at the output of the LT1194, and 1/10 of this signal is applied across the sense resistor. Thus the output current is simply:

$$I_O = \frac{V_{IN}}{R \cdot 10}$$

The compensation capacitor  $C_C$  forces the LT1191 to be the dominate pole for the loop, while the LT1194 is fast enough to be transparent in the feedback path. The ratio of the load resistor to the sense resistor should be approximately 10:1 or greater for easy compensation. For the example shown the load resistor is 100Ω, the sense resistor is 5.1Ω, and various loop compensation capacitors cause the output to exhibit an underdamped, critically and overdamped response.

## Voltage Controlled Current Source

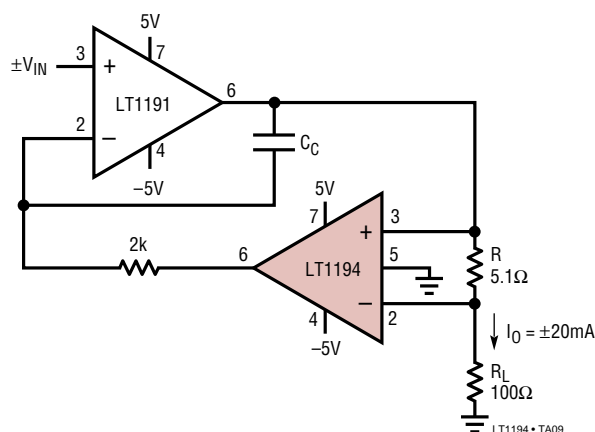

## Output Current Response

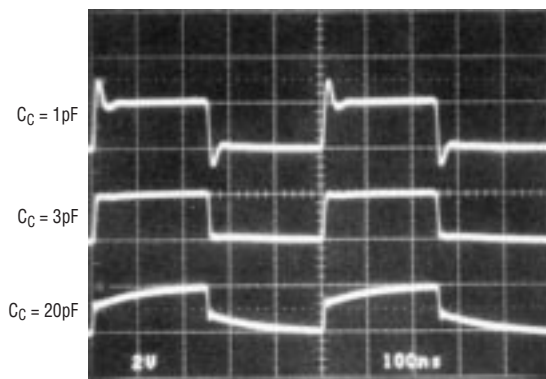

LT1194 • TA10

±20mA CURRENT SOURCE WITH DIFFERENT COMPENSATION CAPACITORS

## Differential Video Loop Thru Amplifier for Power-Down Applications

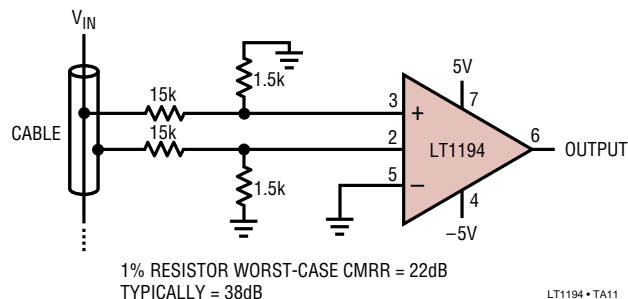

1% RESISTOR WORST-CASE CMRR = 22dB  
TYPICALLY = 38dB

LT1194 • TA11

## APPLICATIONS INFORMATION

### Murphy Circuits

There are several precautions the user should take when using the LT1194 in order to realize its full capability. Although the LT1194 can drive a 50pF capacitive load, isolating the capacitance with 10Ω can be helpful. Precautions primarily have to do with driving large capacitive loads.

Other precautions include:

1. Use a ground plane (see Design Note 50, High Frequency Amplifier Evaluation Board).
2. Do not use high source impedances. The input capacitance of 2pF, and  $R_S = 10k$ , for instance, will give an 8MHz –3dB bandwidth.
3. PC board socket may reduce stability.

Driving Capacitive Load

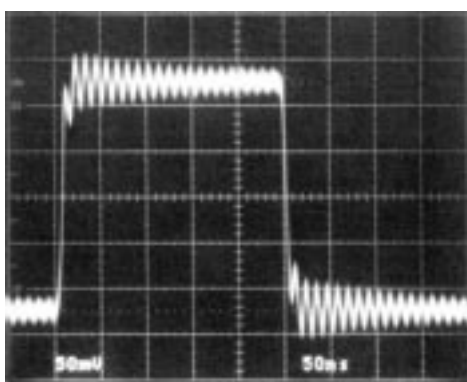

LT1194 • TA12

LT1194 IN DEMO BOARD,  $C_L = 50pF$

Driving Capacitive Load

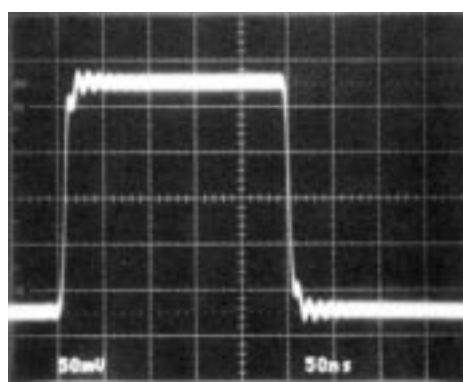

LT1194 • TA13

LT1194 IN DEMO BOARD,  $C_L = 50pF$   
WITH 10Ω ISOLATING RESISTOR

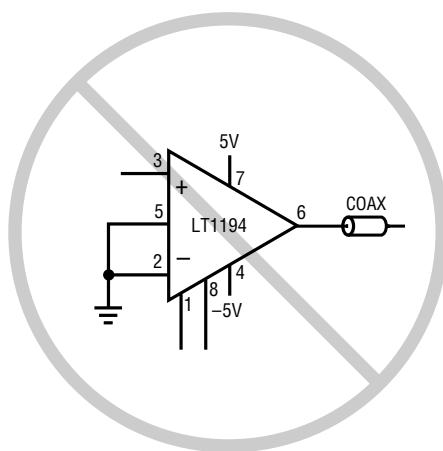

An unterminated cable is a large capacitive load

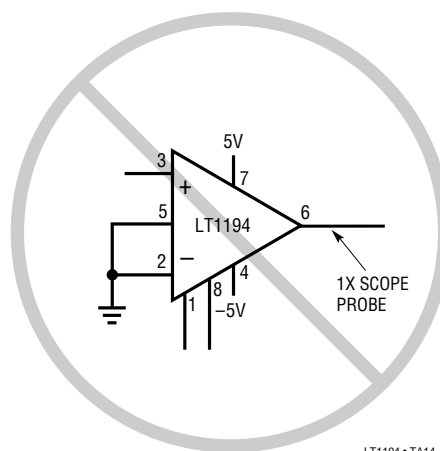

LT1194 • TA14

A 1X Scope Probe is a large capacitive load

## SIMPLIFIED SCHEMATIC

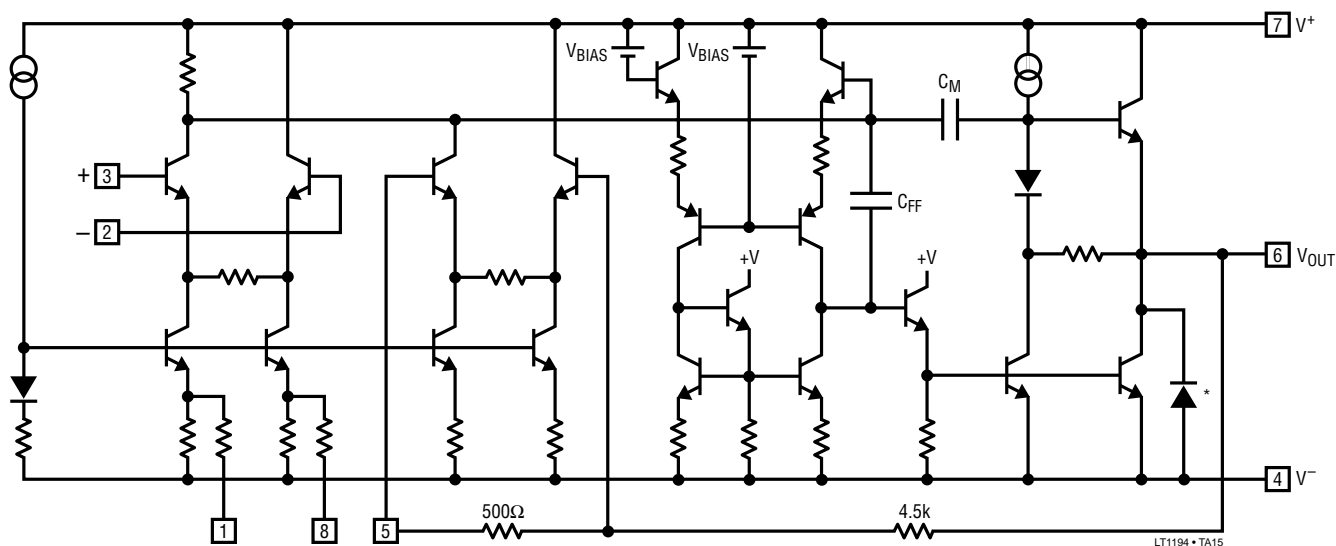

\* SUBSTRATE DIODE, DO NOT FORWARD BIAS

## PACKAGE DESCRIPTION

### J8 Package 8-Lead CERDIP (Narrow .300 Inch, Hermetic) (Reference LTC DWG # 05-08-1110)

CORNER LEADS OPTION  
(4 PLCS)

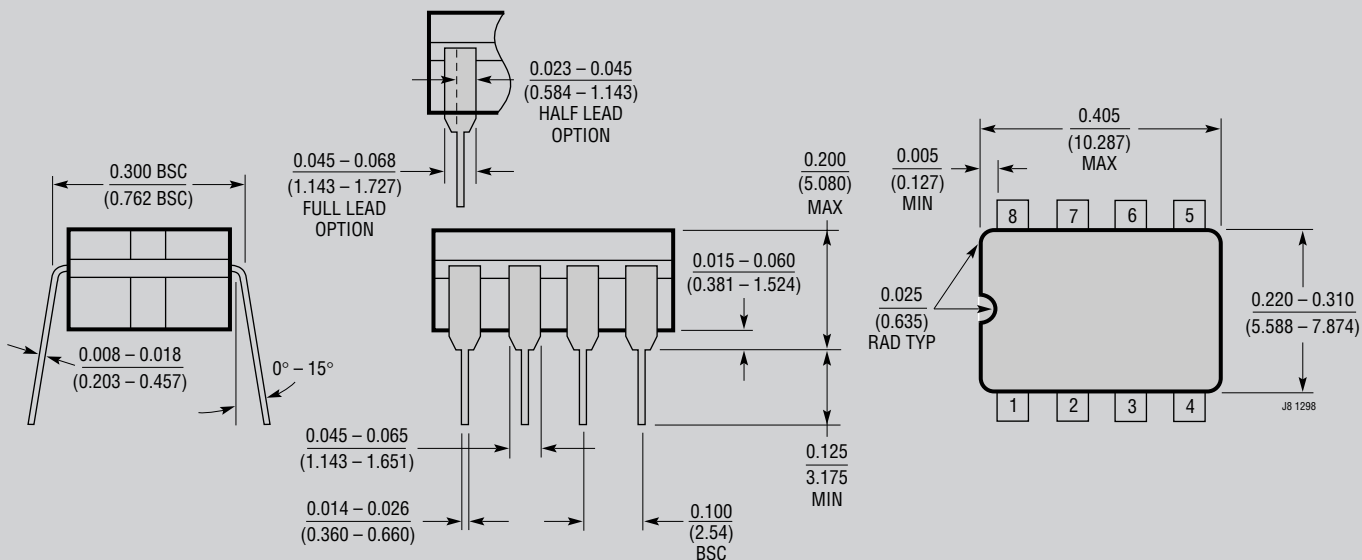

**OBSELETE PACKAGE**

# PACKAGE DESCRIPTION

**N8 Package**  
**8-Lead PDIP (Narrow .300 Inch)**  
 (Reference LTC DWG # 05-08-1510)

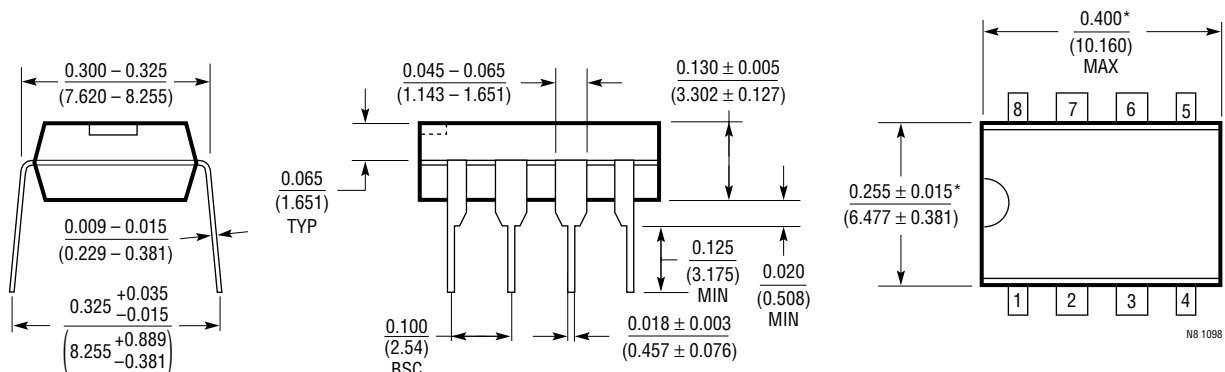

\*THESE DIMENSIONS DO NOT INCLUDE MOLD FLASH OR PROTRUSIONS.  
 MOLD FLASH OR PROTRUSIONS SHALL NOT EXCEED 0.010 INCH (0.254mm)

**S8 Package**  
**8-Lead Plastic Small Outline (Narrow .150 Inch)**  
 (Reference LTC DWG # 05-08-1610)

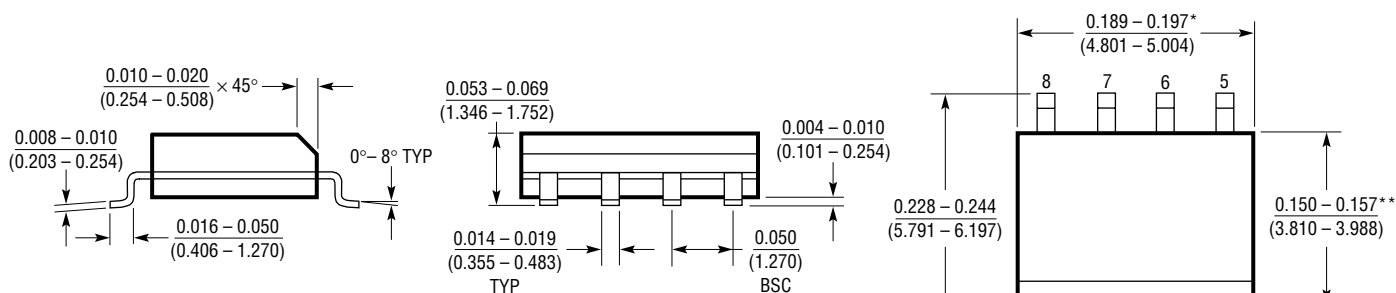

\*DIMENSION DOES NOT INCLUDE MOLD FLASH. MOLD FLASH SHALL NOT EXCEED 0.006" (0.152mm) PER SIDE  
 \*\*DIMENSION DOES NOT INCLUDE INTERLEAD FLASH. INTERLEAD FLASH SHALL NOT EXCEED 0.010" (0.254mm) PER SIDE

## RELATED PARTS

PART NUMBER	DESCRIPTION	COMMENTS
LT1193	$A_V = 2$ Video Difference Amp	80MHz BW, 500V/ $\mu$ s Slew Rate



Компания «ЭлектроПласт» предлагает заключение долгосрочных отношений при поставках импортных электронных компонентов на взаимовыгодных условиях!

Наши преимущества:

- Оперативные поставки широкого спектра электронных компонентов отечественного и импортного производства напрямую от производителей и с крупнейших мировых складов;
- Поставка более 17-ти миллионов наименований электронных компонентов;
- Поставка сложных, дефицитных, либо снятых с производства позиций;
- Оперативные сроки поставки под заказ (от 5 рабочих дней);
- Экспресс доставка в любую точку России;
- Техническая поддержка проекта, помощь в подборе аналогов, поставка прототипов;
- Система менеджмента качества сертифицирована по Международному стандарту ISO 9001;
- Лицензия ФСБ на осуществление работ с использованием сведений, составляющих государственную тайну;
- Поставка специализированных компонентов (Xilinx, Altera, Analog Devices, Intersil, Interpoint, Microsemi, Aeroflex, Peregrine, Syfer, Eurofarad, Texas Instrument, Miteq, Cobham, E2V, MA-COM, Hittite, Mini-Circuits, General Dynamics и др.);

Помимо этого, одним из направлений компании «ЭлектроПласт» является направление «Источники питания». Мы предлагаем Вам помощь Конструкторского отдела:

- Подбор оптимального решения, техническое обоснование при выборе компонента;
- Подбор аналогов;
- Консультации по применению компонента;
- Поставка образцов и прототипов;
- Техническая поддержка проекта;
- Защита от снятия компонента с производства.



#### Как с нами связаться

**Телефон:** 8 (812) 309 58 32 (многоканальный)

**Факс:** 8 (812) 320-02-42

**Электронная почта:** [org@eplast1.ru](mailto:org@eplast1.ru)

**Адрес:** 198099, г. Санкт-Петербург, ул. Калинина, дом 2, корпус 4, литера А.