

LOC		DIST		REVISIONS			
P	LTN	DESCRIPTION	DATE	DMN	APVD		
GP	00						
E2		ADDED NEW DASH NUMBER 2-5	03MAY2012	CZ	SZ		
E3		REVISED	16FEB2013	ML	SZ		
E4		ADD NEW DASH NUMBER 2-6	09MAY2014	CZ	SZ		

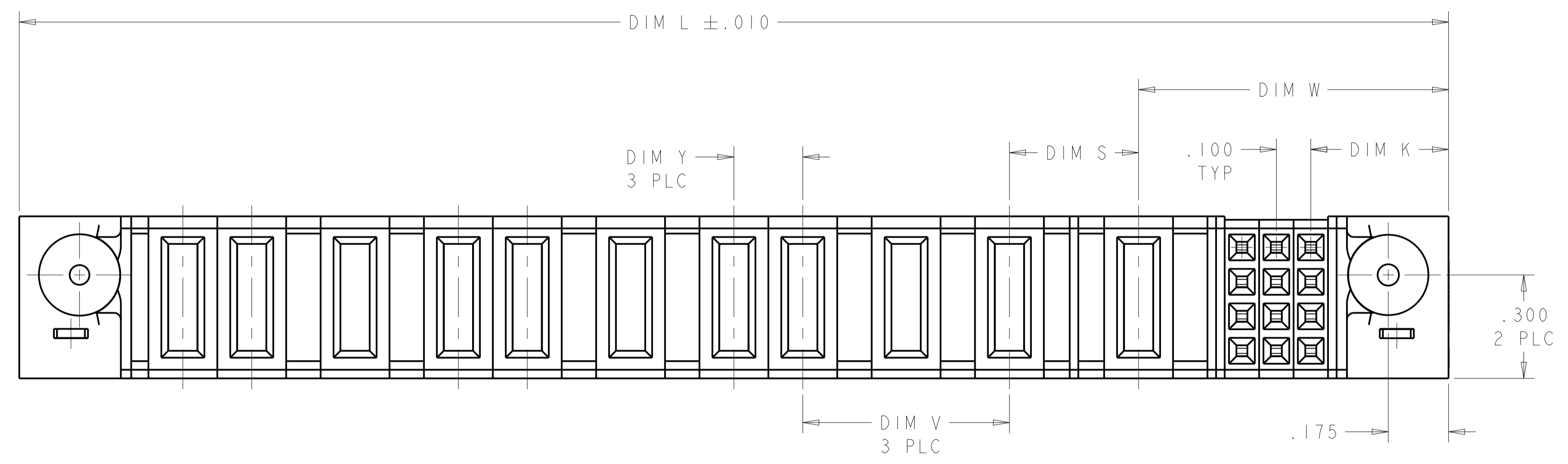

- 1 "AMP", PART NUMBER, AND DATE CODE TO BE MARKED IN AREA SHOWN.
- 2 MATERIAL: HOUSING - GLASS FILLED HIGH TEMP THERMO PLASTIC, UL94 V-O.
SIGNAL CONTACT - HIGH CONDUCTIVITY COPPER ALLOY
POWER CONTACT - HIGH CONDUCTIVITY COPPER ALLOY
- 3 CONTACT PLATING: NOBLE METAL PLATED ON THE CONTACT FUNCTIONAL AREA OF POWER AND SIGNAL CONTACTS.
- 4 MECHANICAL CONNECTOR KEEP OUT ZONE.
- 5 DATUM AND BASIC DIMENSIONS ESTABLISHED BY CUSTOMER.
- 6 PCB - ALL HOLE DIAMETERS ARE FINISHED HOLE SIZES.
- 7 PCB - .0453 +/- .0010 DRILLED HOLES PLATED WITH .0003 MIN Sn OVER .001 TO .003 PLATING TO ACHIEVE A .040 DIA. HOLE.
- 8 FOR DETAIL DIM PLEASE REFER TO TABLE

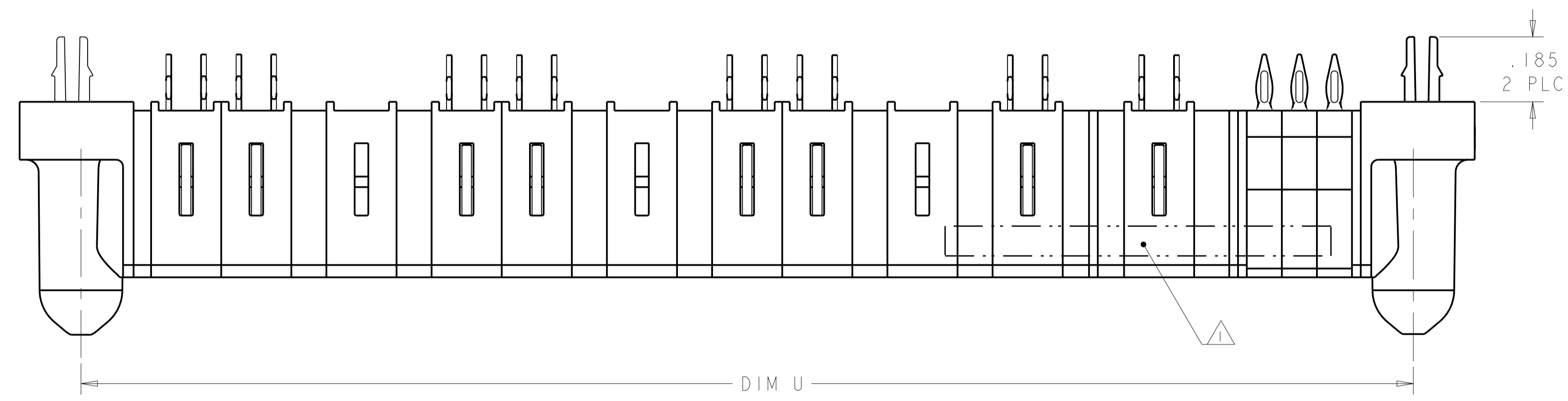
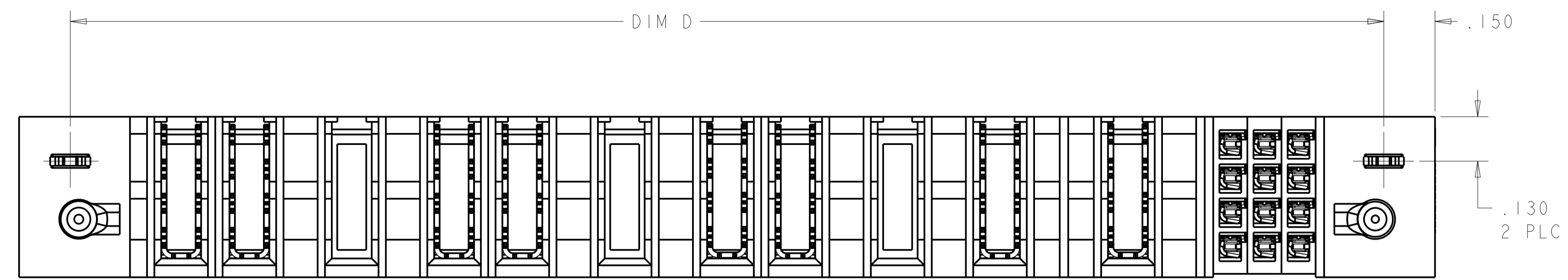
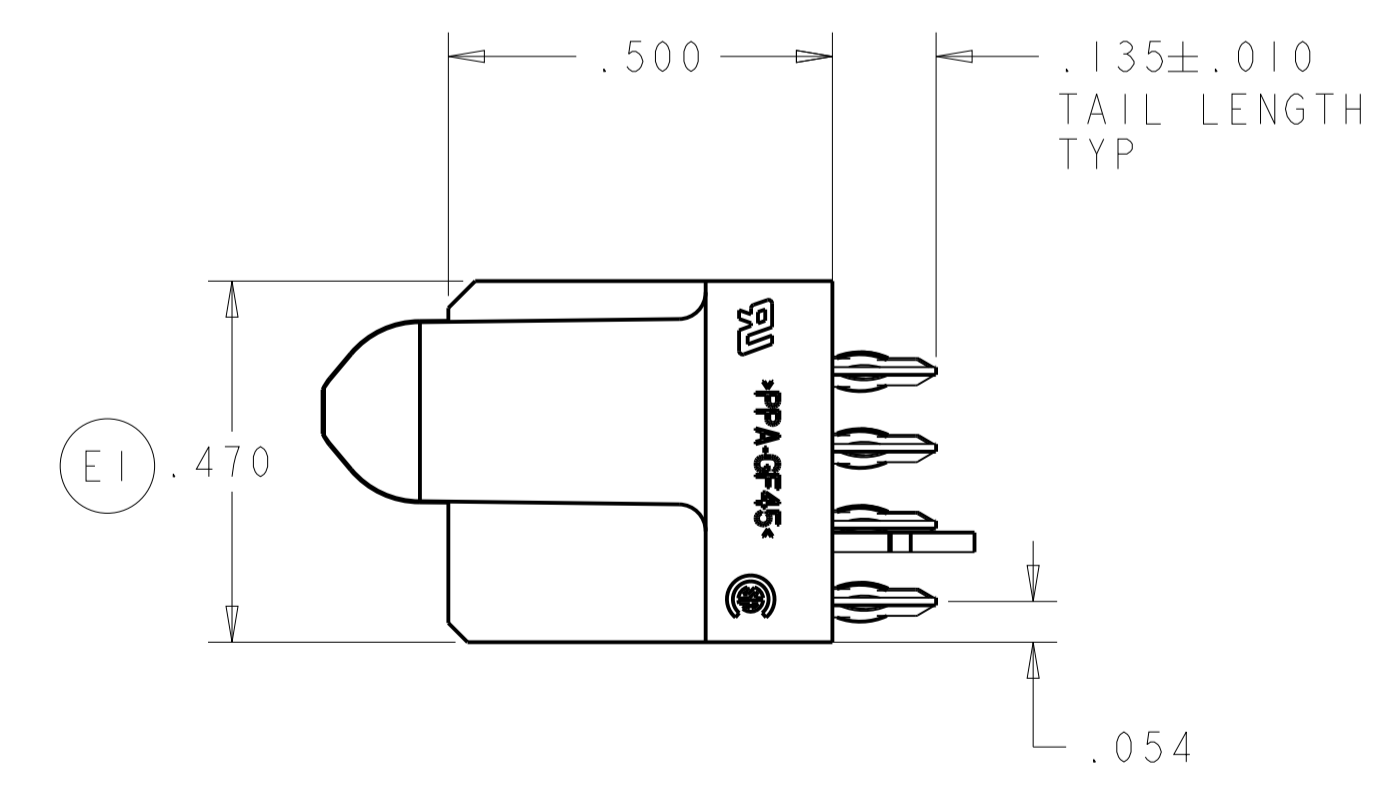

THIS DRAWING IS A CONTROLLED DOCUMENT.		DMN R. GRZYBOWSKI 02MAY05	TE Connectivity										
DIMENSIONS: INCHES		CHK M. PERCHERKE 02MAY05											
TOLERANCES UNLESS OTHERWISE SPECIFIED:		APVD M. PERCHERKE 02MAY05	NAME VERTICAL RECEPTACLE WITH GUIDES MULTI-BEAM XL										
<table border="1"> <tr> <td>0 PLC</td> <td>±</td> </tr> <tr> <td>2 PLC</td> <td>±.01</td> </tr> <tr> <td>3 PLC</td> <td>±.005</td> </tr> <tr> <td>4 PLC</td> <td>±.0020</td> </tr> <tr> <td>ANGLES</td> <td>±.020</td> </tr> </table>		0 PLC	±	2 PLC	±.01	3 PLC	±.005	4 PLC	±.0020	ANGLES	±.020	PRODUCT SPEC 108-1973	SIZE A1
0 PLC	±												
2 PLC	±.01												
3 PLC	±.005												
4 PLC	±.0020												
ANGLES	±.020												
MATERIAL		APPLICATION SPEC 114-13038	CAGE CODE DRAWING NO 00779										
FINISH		WEIGHT	RESTRICTED TO										
CUSTOMER DRAWING		SCALE 4:1	SHEET 1 OF 12										

THIS DRAWING IS UNPUBLISHED. RELEASED FOR PUBLICATION 20
 © COPYRIGHT 20 BY - ALL RIGHTS RESERVED.

LOC	DIST	REVISIONS					
		P	LTN	DESCRIPTION	DATE	DWN	APVD
GP	00	-	-	SEE SHEET 1	-	-	-

E4	-	-	2.400	.250	.375	2.750	1.050	2.450	24S + 6P	2-6450541-6
	-	-	-	-	.425	2.350	-	2.050	64S	2-6450541-5
	-	-	1.100	-	.375	1.450	-	1.150	32S	2-6450541-4
	-	-	3.800	.250	.375	4.150	3.450	3.850	120S + 2P	2-6450541-3
	-	-	1.500	.250	.375	1.850	0.625	1.550	8S + 4P	2-6450541-2
	-	-	1.600	.250	.375	1.950	0.725	1.650	12S + 4P	2-6450541-1
	-	-	6.075	.200	.375	6.425	1.375	6.125	36S + 24P	2-6450541-0
	-	-	4.025	$\frac{8}{\Delta}$.375	4.375	2.125	4.075	60S + 8P	1-6450541-9
	-	-	2.925	.200	.375	3.275	1.025	2.975	24S + 10P	1-6450541-8
	-	-	2.400	.250	.375	2.750	1.050	-	24S + 6P	1-6450541-7
	-	-	1.750	.200	.375	2.100	.650	-	8S + 6HDP	1-6450541-4
	-	-	0.950	.200	.375	1.300	.650	-	8S + 2HDP	1-6450541-3
	-	-	1.700	.250	.375	2.050	.850	-	16S + 4P	1-6450541-2
	-	-	2.850	.200	.375	3.200	.950	-	20S + 10HDP	6450541-7
	-	-	2.900	.250	.375	3.250	1.050	-	24S + 8P	6450541-5
	-	-	2.400	.250	.375	2.750	1.050	-	24S + 6P	6450541-4
	-	-	1.900	.250	.375	2.250	1.050	-	24S + 4P	6450541-3
	-	-	4.400	.250	.375	4.750	1.050	-	24S + 14P	6450541-2
	.200	.600	3.800	.375	.400	4.150	.900	3.850	12S + 11P	6450541-1
	DIM Y	DIM V	DIM U	DIM S	DIM K	DIM L	DIM W	DIM D	DESCRIPTION	PART NUMBER

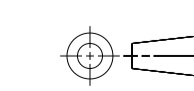
THIS DRAWING IS A CONTROLLED DOCUMENT.		DWN R. GRZYBOWSKI 02MAY05	 TE Connectivity	
DIMENSIONS: INCHES		CHK M. PERCHERKE 02MAY05		
TOLERANCES UNLESS OTHERWISE SPECIFIED:		APVD M. PERCHERKE 02MAY05	NAME VERTICAL RECEPTACLE WITH GUIDES MULTI-BEAM XL	
0 PLC ±. 1 PLC ±. 2 PLC ±.01 3 PLC ±.005 4 PLC ±.0020 ANGLES ±.020		PRODUCT SPEC 108-1973	SIZE A100779	
		APPLICATION SPEC 114-13038	DRAWING NO 6450541	
MATERIAL -		FINISH -	WEIGHT -	RESTRICTED TO -
CUSTOMER DRAWING		SCALE 4:1		SHEET 2 OF 12
		REV E4		

LOC	DIST	REVISIONS			
GP	00	REV	DATE	BY	APPV
		1			
		2			

PART NUMBER	ROWS	POWER										SIGNAL				
		P11	P10	P9	P8	P7	P6	P5	P4	P3	P2	P1	3	2	1	
6450541-1	D C B A												AP	AP	AP	
			GP	GP		GP	GP		GP	GP		GP		AP	AP	AP
														AP	AP	AP
														AP	AP	AP
12S + 11P																

ASSY PART NUMBER	ROWS	POWER														SIGNAL						
		P14	P13	P12	P11	P10	P9	P8	P7	P6	P5	P4	P3	P2	P1	6	5	4	3	2	1	
6450541-2	D C B A																					
			GP	GP	GP	GP	GP	GP	GP	GP	GP	GP	GP	GP	GP	GP		AP	AP	AP	AP	AP
																		AP	AP	AP	AP	AP
																		AP	AP	AP	AP	AP
24S + 14P																						

NO CONTACTS LOADED

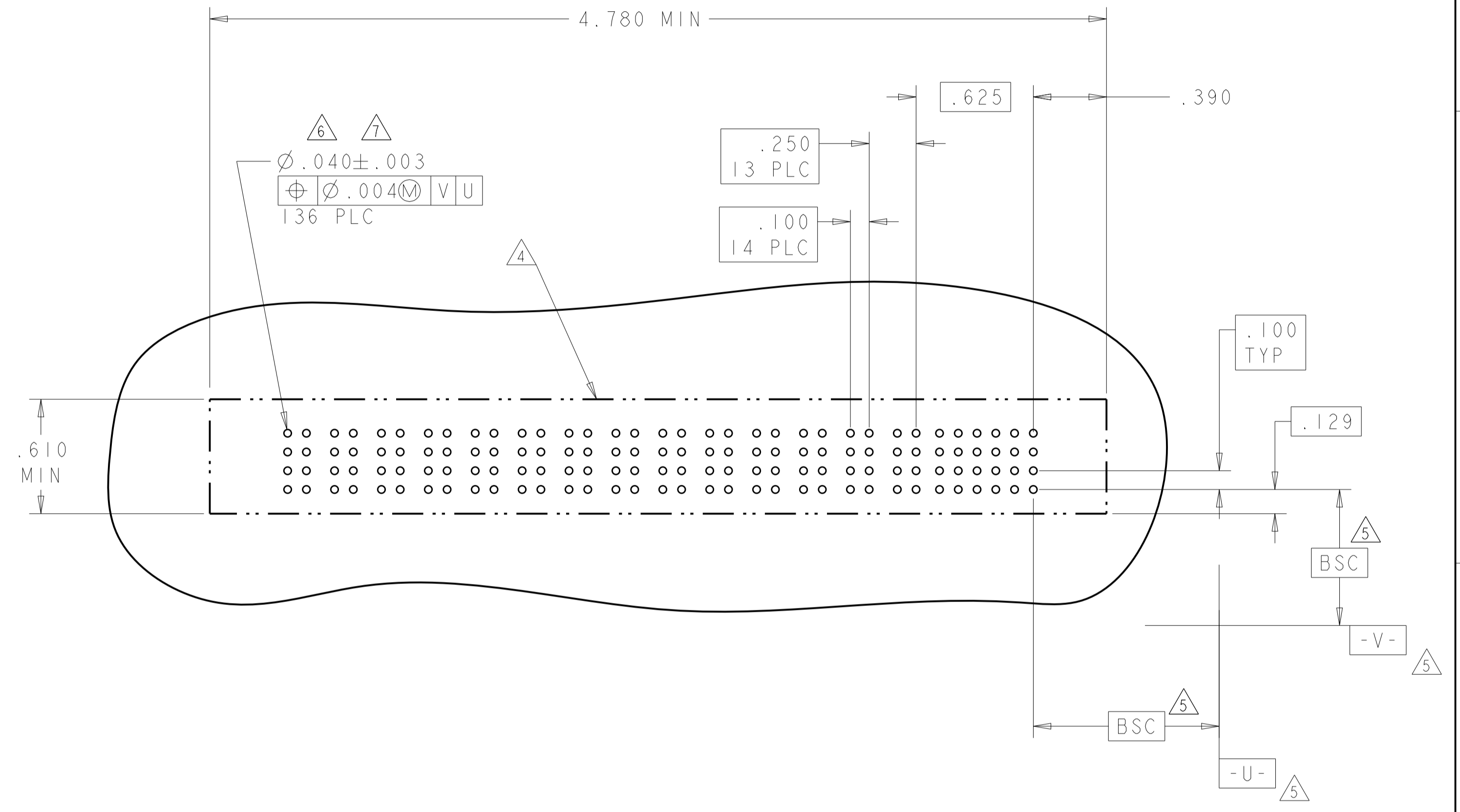
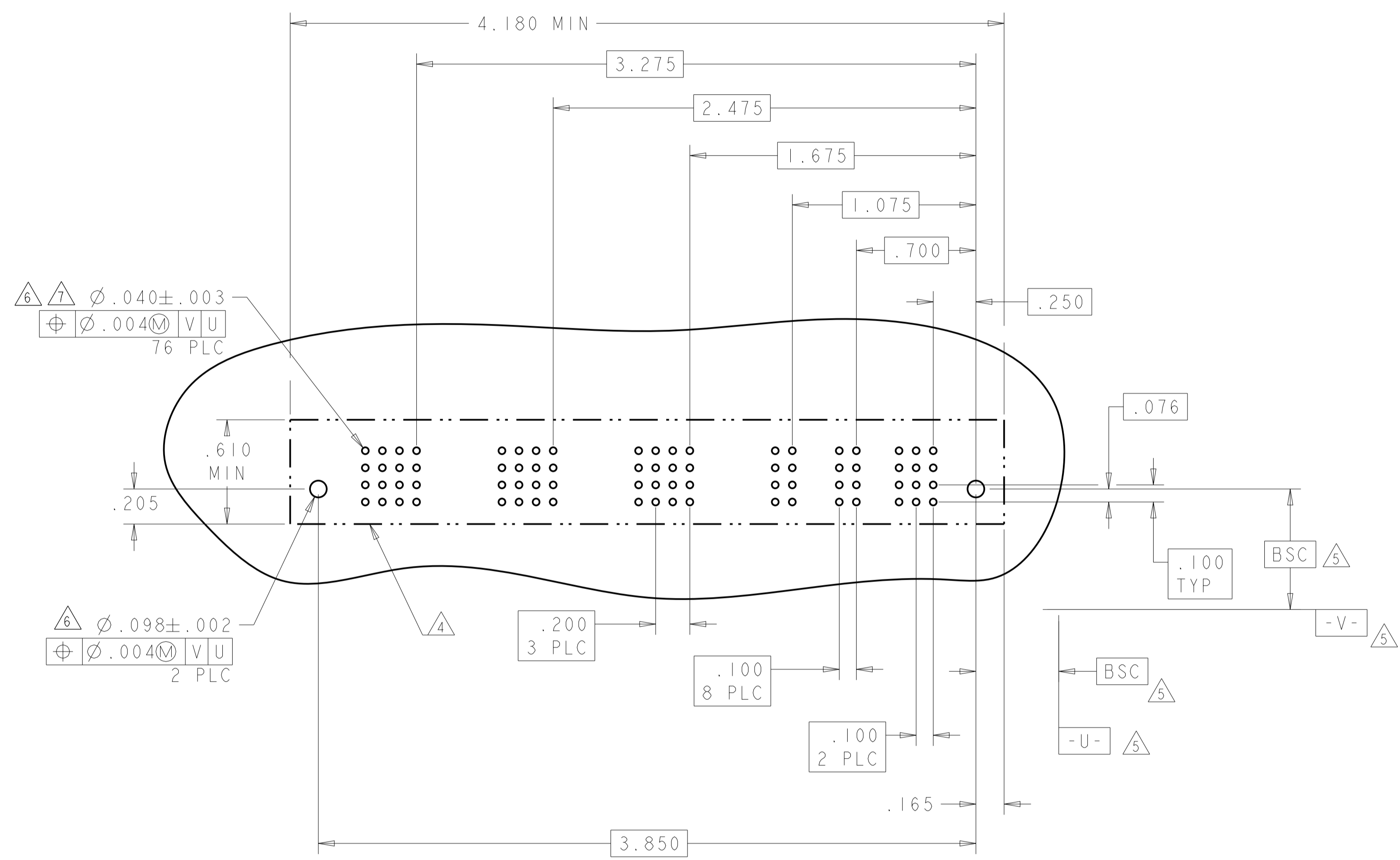

TAIL LENGTH	CODE	DESCRIPTION
.165	HS	STD POWER PRESS FIT CONTACT
.165	BP	SIGNAL PRESS FIT CONTACT
.135	GS	STD POWER PRESSFIT CONTACT
.135	GP	MFBL POWER PRESSFIT CONTACT
.135	AP	SIGNAL PRESSFIT CONTACT

CONTACT TABLE

THIS DRAWING IS A CONTROLLED DOCUMENT.		OWN: R. GRZYBOWSKI 02MAY05	 TE Connectivity
DIMENSIONS: INCHES		CHK: M. PERCHERKE 02MAY05	
TOLERANCES UNLESS OTHERWISE SPECIFIED:		APPV: M. PERCHERKE 02MAY05	
0 PLC ± .01 1 PLC ± .01 2 PLC ± .01 3 PLC ± .005 4 PLC ± .002 ANGLES ± .020		NAME: VERTICAL RECEPTACLE WITH GUIDES MULTI-BEAM XL	
MATERIAL: -	FINISH: -	PRODUCT SPEC: 108-1973	SIZE: 114-13038
CUSTOMER DRAWING		WEIGHT: -	RESTRICTED TO: -
		SCALE: 4:1	SHEET 3 OF 12
		REV: 4	

LOC	DIST	REV	DATE	BY	APPV
GP	00				

REVISIONS		DATE	BY	APPV
1	SEE SHEET 1			

ASSY PART NUMBER	ROWS	POWER				SIGNAL						
		P4	P3	P2	PI	6	5	4	3	2	1	
6450541-3	D C B A	GP	GP	GP	GP	AP	AP	AP	AP	AP	AP	AP
		GP	GP	GP	GP	AP	AP	AP	AP	AP	AP	AP
		GP	GP	GP	GP	AP	AP	AP	AP	AP	AP	AP
		GP	GP	GP	GP	AP	AP	AP	AP	AP	AP	AP
24S + 4P												

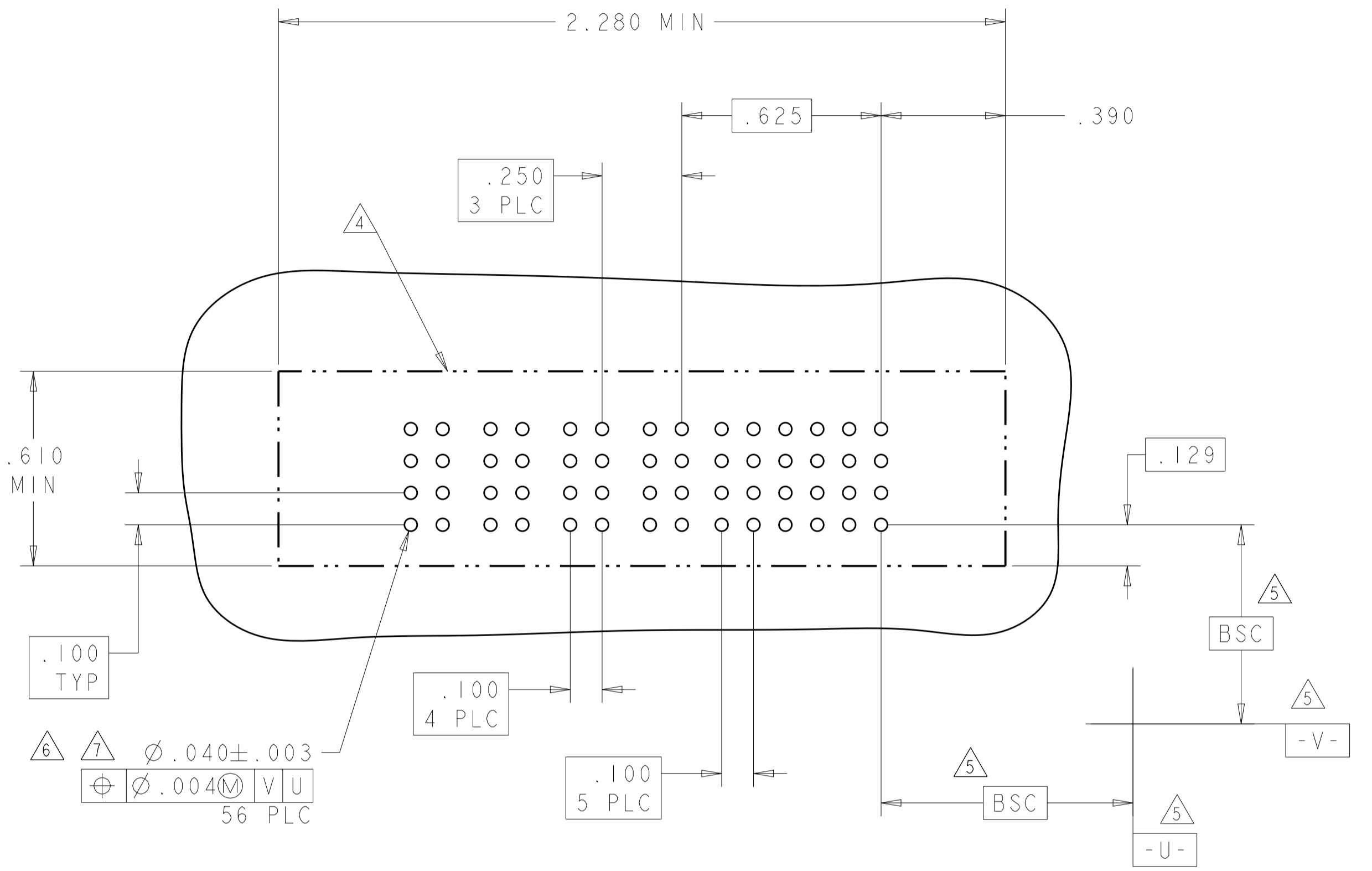

PART NUMBER	ROWS	POWER								SIGNAL					
		P8	P7	P6	P5	P4	P3	P2	PI	6	5	4	3	2	1
6450541-5	D C B A	GP	GP	GP	GP	GP	GP	GP	GP	AP	AP	AP	AP	AP	AP
		GP	GP	GP	GP	GP	GP	GP	GP	AP	AP	AP	AP	AP	AP
		GP	GP	GP	GP	GP	GP	GP	GP	AP	AP	AP	AP	AP	AP
		GP	GP	GP	GP	GP	GP	GP	GP	AP	AP	AP	AP	AP	AP
24S + 8P															

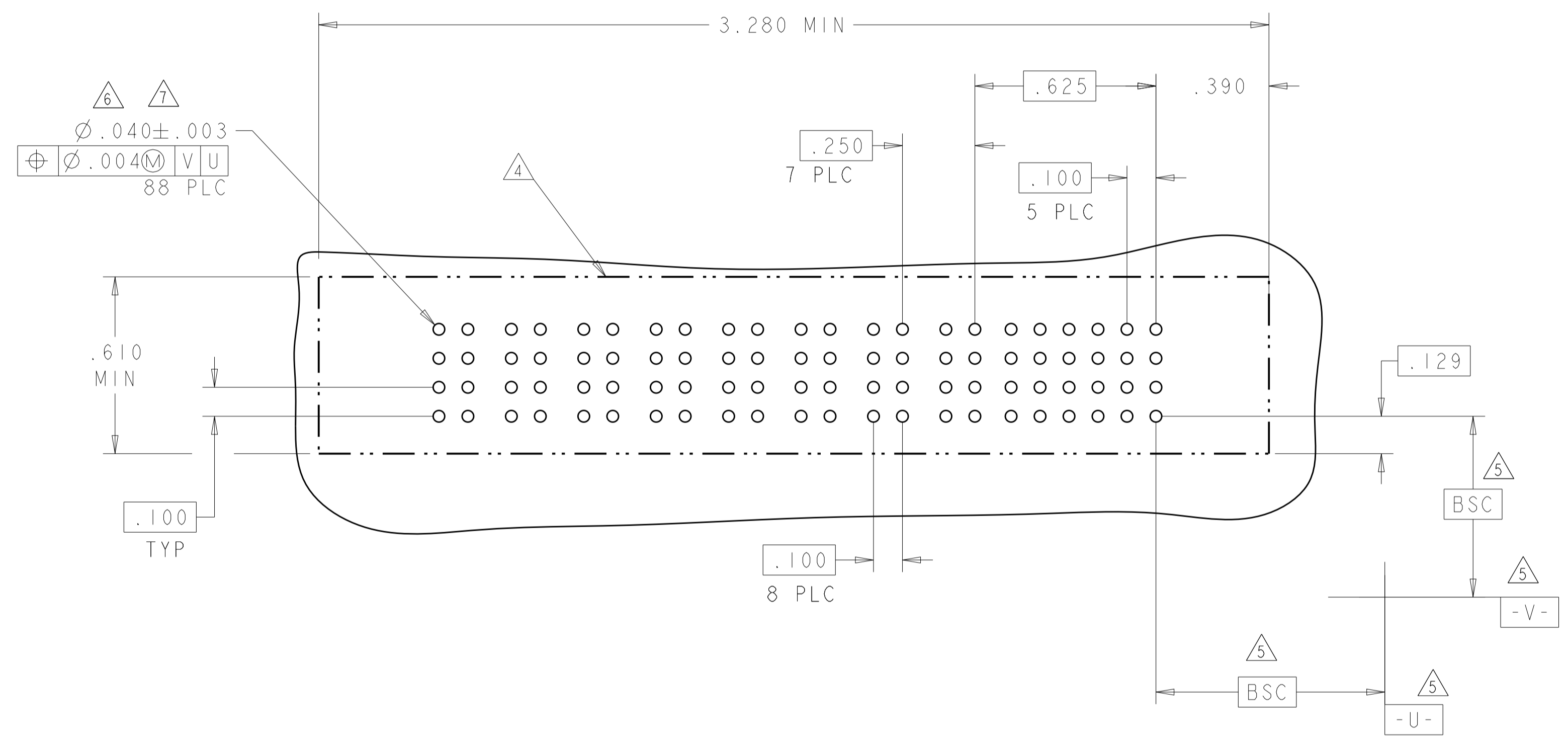

ASSY PART NUMBER	ROWS	POWER						SIGNAL					
		P6	P5	P4	P3	P2	PI	6	5	4	3	2	1
6450541-4	D C B A	GP	GP	GP	GP	GP	GP	AP	AP	AP	AP	AP	AP
		GP	GP	GP	GP	GP	GP	AP	AP	AP	AP	AP	AP
		GP	GP	GP	GP	GP	GP	AP	AP	AP	AP	AP	AP
		GP	GP	GP	GP	GP	GP	AP	AP	AP	AP	AP	AP
24S + 6P													

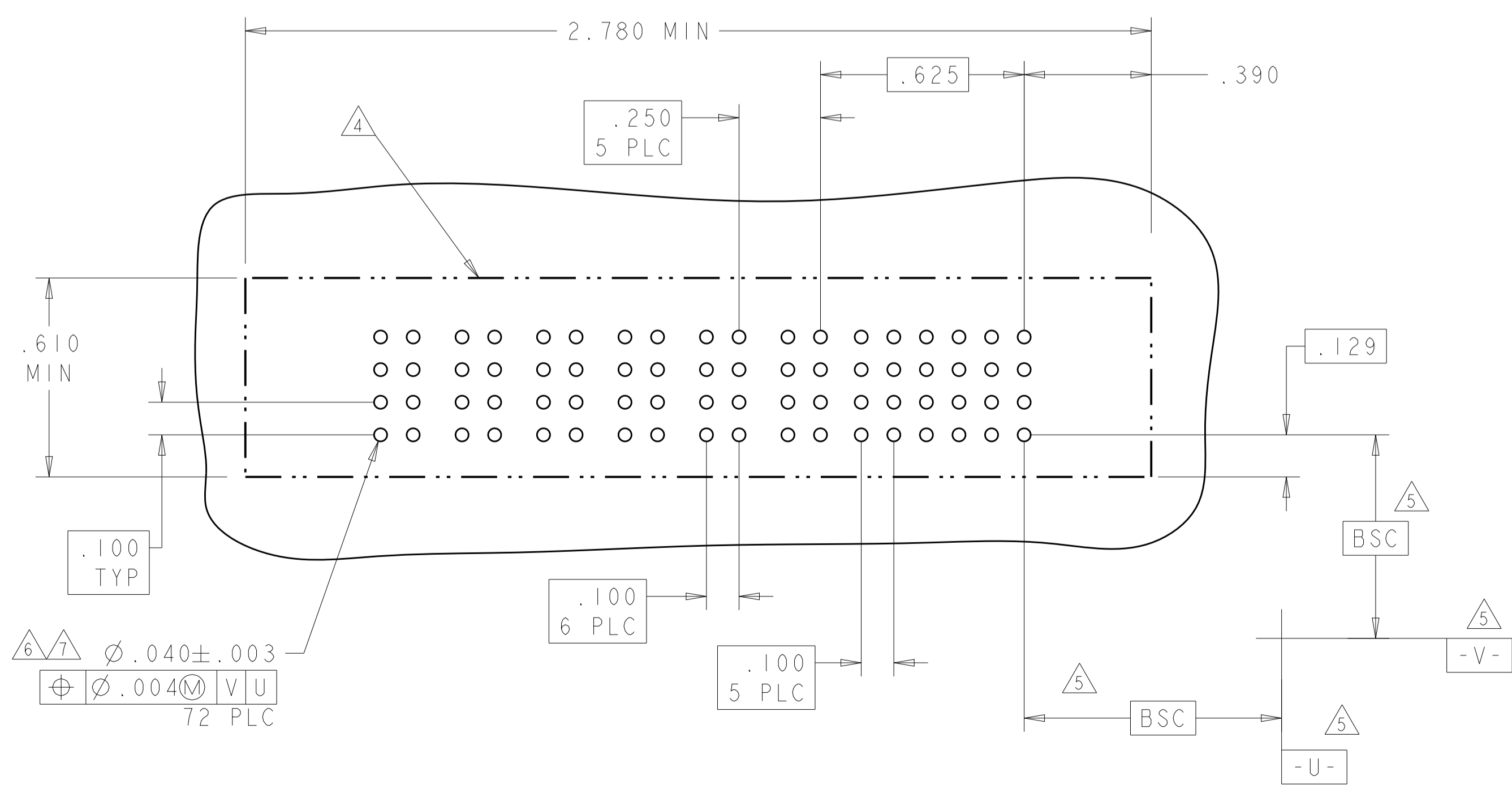

THIS DRAWING IS A CONTROLLED DOCUMENT.		OWN: R. GRZYBOWSKI 02MAY05	TE Connectivity VERTICAL RECEPTACLE WITH GUIDES MULTI-BEAM XL
DIMENSIONS: INCHES		CHK: M. PERCHERKE 02MAY05	
TOLERANCES UNLESS OTHERWISE SPECIFIED:		APVD: M. PERCHERKE 02MAY05	NAME: 108-1973
0 PLC ± .01 1 PLC ± .01 2 PLC ± .01 3 PLC ± .005 4 PLC ± .002 ANGLES ± .020		PRODUCT SPEC: 108-1973	APPLICATION SPEC: 114-13038
MATERIAL: -		FINISH: -	WEIGHT: -
CUSTOMER DRAWING		SCALE: 4:1	SHEET 4 OF 12

LOC	DIST	REVISIONS			
P	LTN	DESCRIPTION	DATE	DWN	APVD
GP	00	SEE SHEET 1			

ASSY PART NUMBER	ROWS	POWER						SIGNAL					
		P6	P5	P4	P3	P2	P1	6	5	4	3	2	1
1-6450541-7	D C B A	GS	GS	GS	GS	GS	GS	AP	AP	AP	AP	AP	AP
24S + 6P								AP	AP	AP	AP	AP	AP

PART NUMBER	ROWS	POWER				SIGNAL		
		P4	P3	P2	P1	3	2	1
2-6450541-1	D C B A	GS	GS	GS	GS	AP	AP	AP
12S + 4P						AP	AP	AP

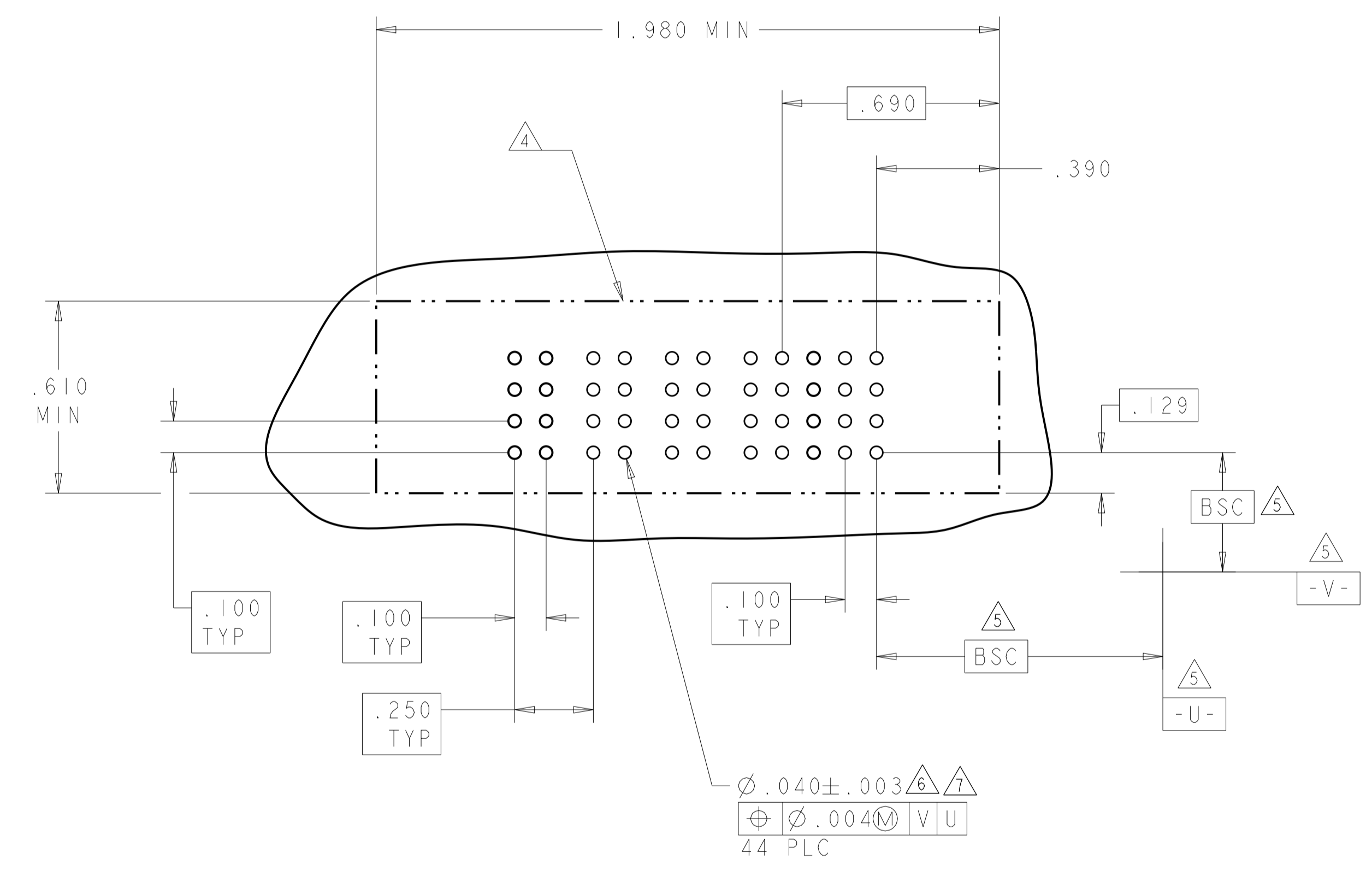
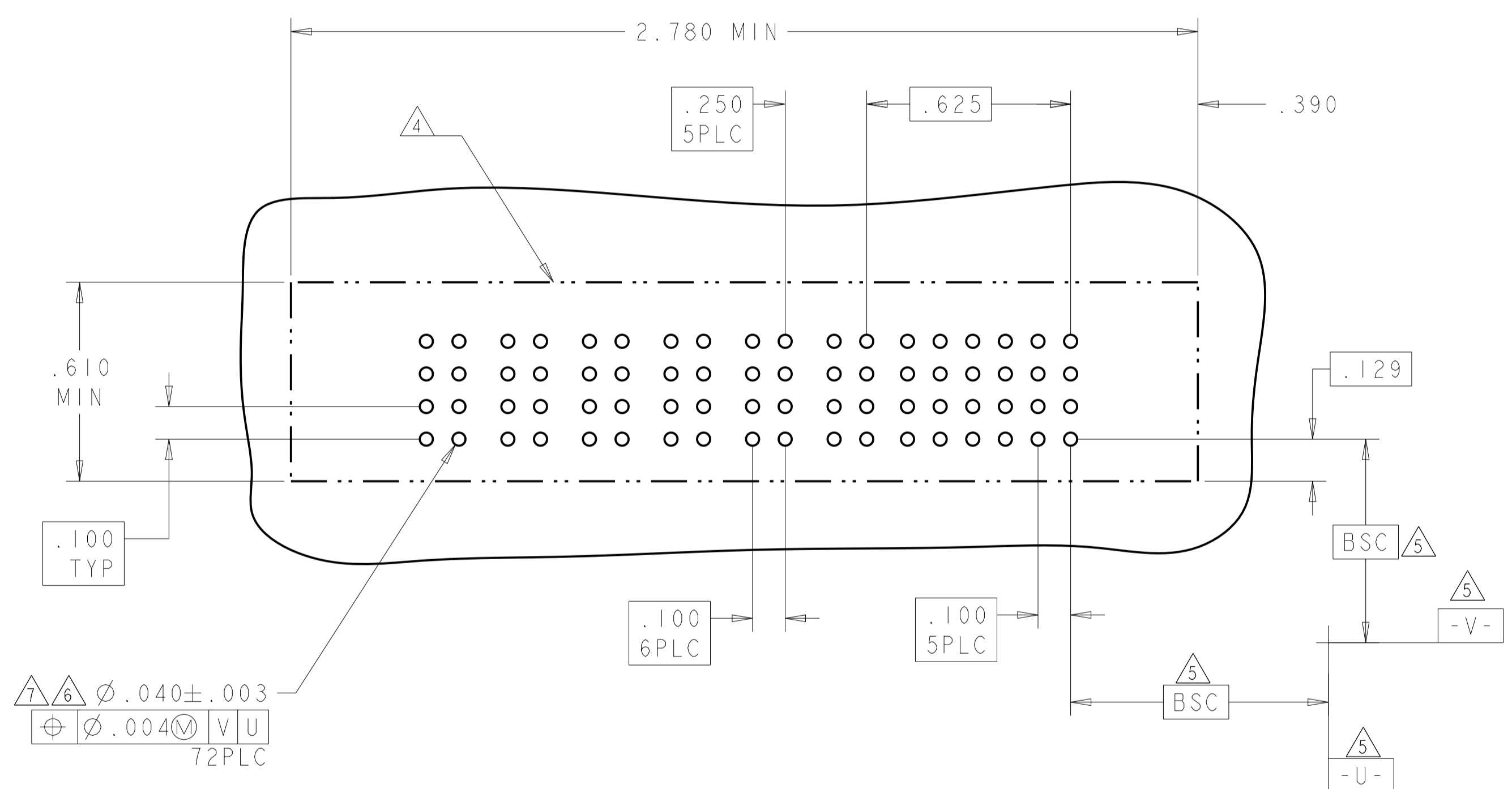

THIS DRAWING IS A CONTROLLED DOCUMENT.

DIMENSIONS: INCHES	TOLERANCES UNLESS OTHERWISE SPECIFIED:	OWN: R. GRZYBOWSKI 02MAY05	CHK: M. PERCHERKE 02MAY05	APVD: M. PERCHERKE 02MAY05	NAME: VERTICAL RECEPTACLE WITH GUIDES MULTI-BEAM XL
0 PLC ±.01	1 PLC ±.01	PRODUCT SPEC: 108-1973	APPLICATION SPEC: 114-13038	WEIGHT: -	SIZE: A1
2 PLC ±.01	3 PLC ±.005	SCALE: 4:1	SHEET: 6 OF 12	REV: E4	RESTRICTED TO: -
4 PLC ±.0020	ANGLES ±.020	CUSTOMER DRAWING			

4805 (3/11)

LOC	DIST	REVISIONS			
P	LTN	DESCRIPTION	DATE	DWN	APVD
-	-	SEE SHEET 1	-	-	-

ASSY PART NUMBER	ROWS	POWER										SIGNAL						
		P10	P9	P8	P7	P6	P5	P4	P3	P2	P1	6	5	4	3	2	1	
1-6450541-8	D C B A	GS	GS	GS	GS		GS	GS	GS	GS		AP	AP	AP	AP			
												AP	AP	AP	AP			
												AP	AP	AP	AP			
												AP	AP	AP	AP			
24S + 10P																		

NO CONTACTS LOADED

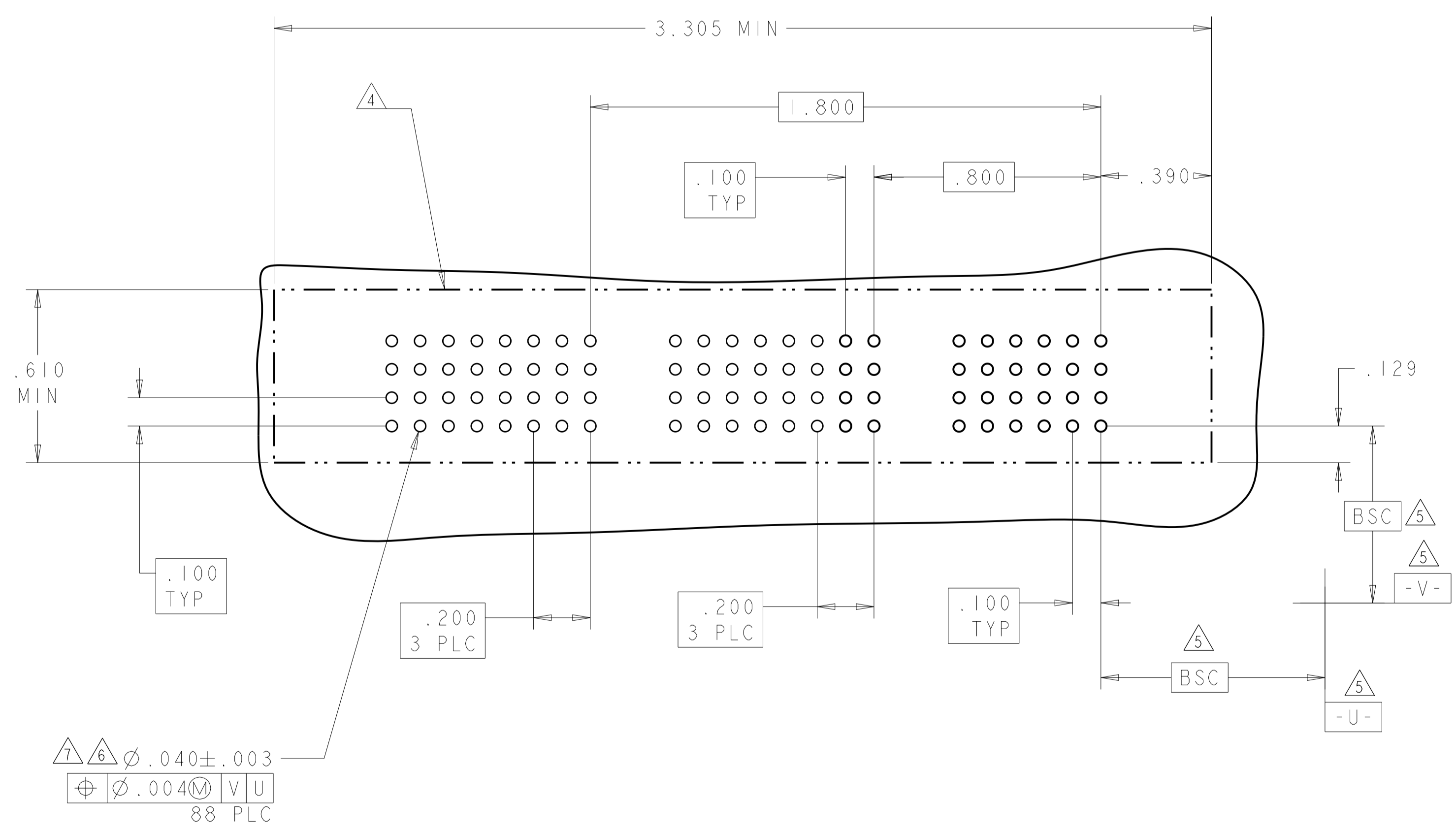

THIS DRAWING IS A CONTROLLED DOCUMENT.

DIMENSIONS: INCHES	TOLERANCES UNLESS OTHERWISE SPECIFIED: 0 PLC ±. 1 PLC ±.01 2 PLC ±.01 3 PLC ±.005 4 PLC ±.0020 ANGLES ±.7°	DWN: B. GRZYBOWSKI 02MAY05 CHK: M. PERCHERKE 02MAY05 APVD: M. PERCHERKE 02MAY05	NAME: VERTICAL RECEPTACLE WITH GUIDES MULTI-BEAM XL
MATERIAL: -	FINISH: -	PRODUCT SPEC: 108-1973 APPLICATION SPEC: 114-13038 WEIGHT: -	SIZE: A1 CAGE CODE: 6450541 RESTRICTED TO: -
CUSTOMER DRAWING		SCALE: 4:1	SHEET 7 OF 12 REV: E4

4805 (3/11)

LOC		DIST		REVISIONS				
GP	00	P	LTN	DESCRIPTION	DATE	DMN	APVD	
		-		SEE SHEET 1				

ASSY PART NUMBER	ROWS	POWER								SIGNAL															
		P8	P7	P6	P5	P4	P3	P2	P1	15	14	13	12	11	10	9	8	7	6	5	4	3	2	1	
1-6450541-9	D C B A	GS	GS	GS	GS	GS	GS	GS	GS	AP	AP	AP	AP	AP	AP	AP	AP	AP	AP	AP	AP	AP	AP	AP	AP
		GS	GS	GS	GS	GS	GS	GS	GS	AP	AP	AP	AP	AP	AP	AP	AP	AP	AP	AP	AP	AP	AP	AP	AP
		GS	GS	GS	GS	GS	GS	GS	GS	AP	AP	AP	AP	AP	AP	AP	AP	AP	AP	AP	AP	AP	AP	AP	AP
		GS	GS	GS	GS	GS	GS	GS	GS	AP	AP	AP	AP	AP	AP	AP	AP	AP	AP	AP	AP	AP	AP	AP	AP

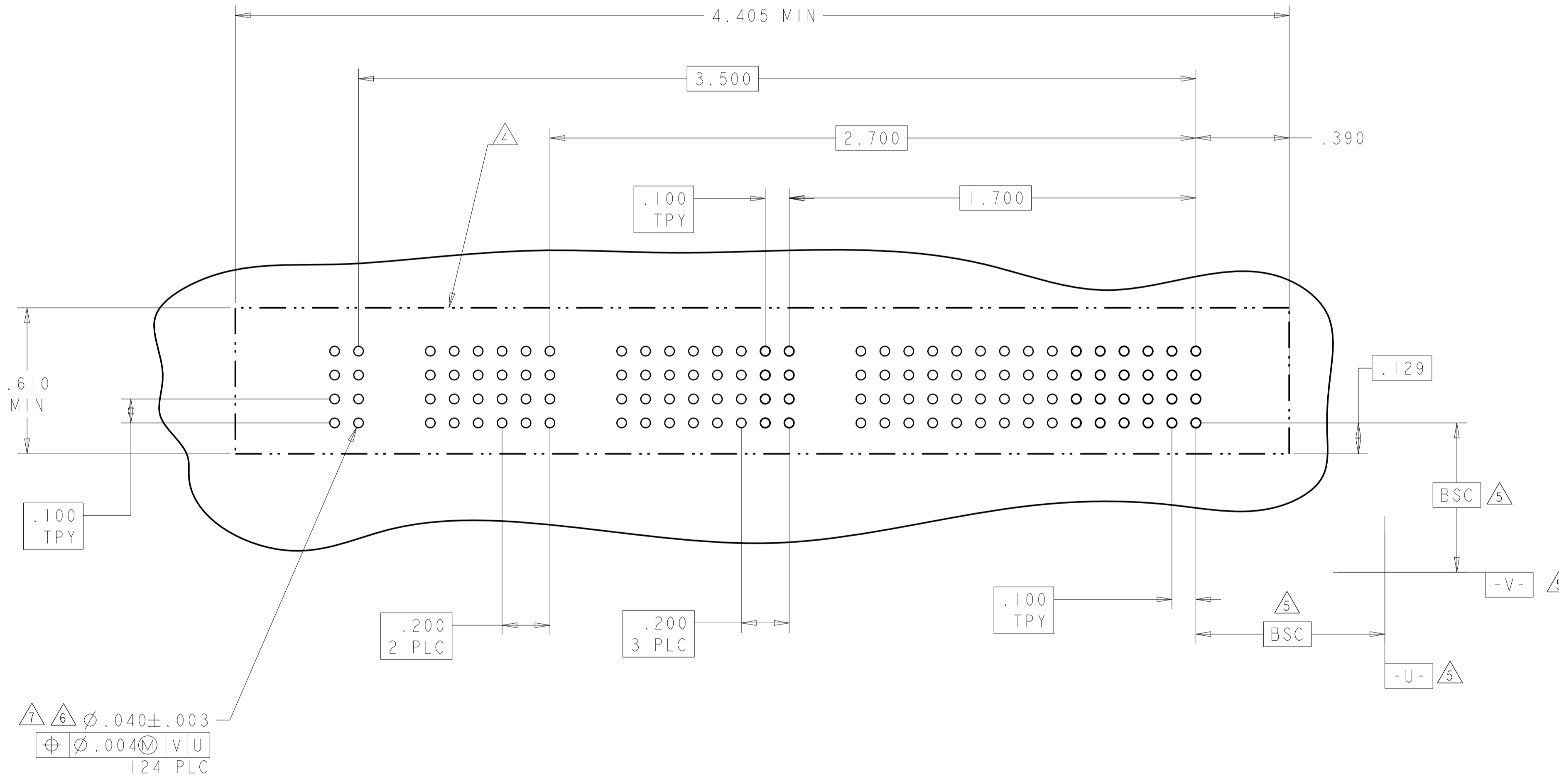
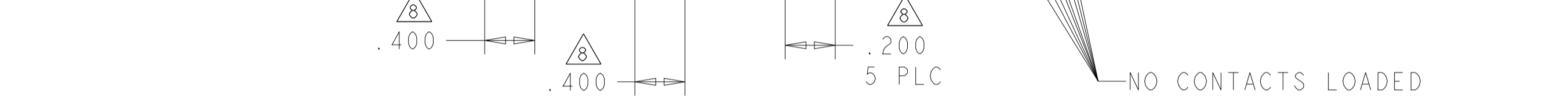

THIS DRAWING IS A CONTROLLED DOCUMENT.

DIMENSIONS: INCHES	TOLERANCES UNLESS OTHERWISE SPECIFIED: 0 PLC ±. 1 PLC ±.01 2 PLC ±.01 3 PLC ±.005 4 PLC ±.0020 ANGLES ±.2°	FINISH: -	APPROVED: M. PERCHERKE 02MAY05	DATE: 108-1973	SCALE: 4:1	APPROVED: M. PERCHERKE 02MAY05	DATE: 114-13038	SCALE: 4:1	SHEET: 8	OF: 12	REV: E4
-----------------------	--	--------------	--------------------------------------	-------------------	---------------	--------------------------------------	--------------------	---------------	-------------	-----------	------------

TE Connectivity
 VERTICAL RECEPTACLE WITH GUIDES
 MULTI-BEAM XL
 A100779C=6450541
 CUSTOMER DRAWING

LOC		DIST		REVISONS			
P	LTN	DESCRIPTION	DATE	DMN	APVD		
-	-	SEE SHEET 1	-	-	-		

PART NUMBER	ROWS	POWER				SIGNAL	
		P4	P3	P2	P1	2	1
2-6450541-2	D	GS	GS	GS	GS	AP	AP
	C					AP	AP
	B					AP	AP
	A					AP	AP

8S + 4P

PART NUMBER	ROWS	SIGNAL							
		8	7	6	5	4	3	2	1
2-6450541-4	D	AP	AP	AP	AP	AP	AP	AP	AP
	C	AP	AP	AP	AP	AP	AP	AP	AP
	B	AP	AP	AP	AP	AP	AP	AP	AP
	A	AP	AP	AP	AP	AP	AP	AP	AP

32S

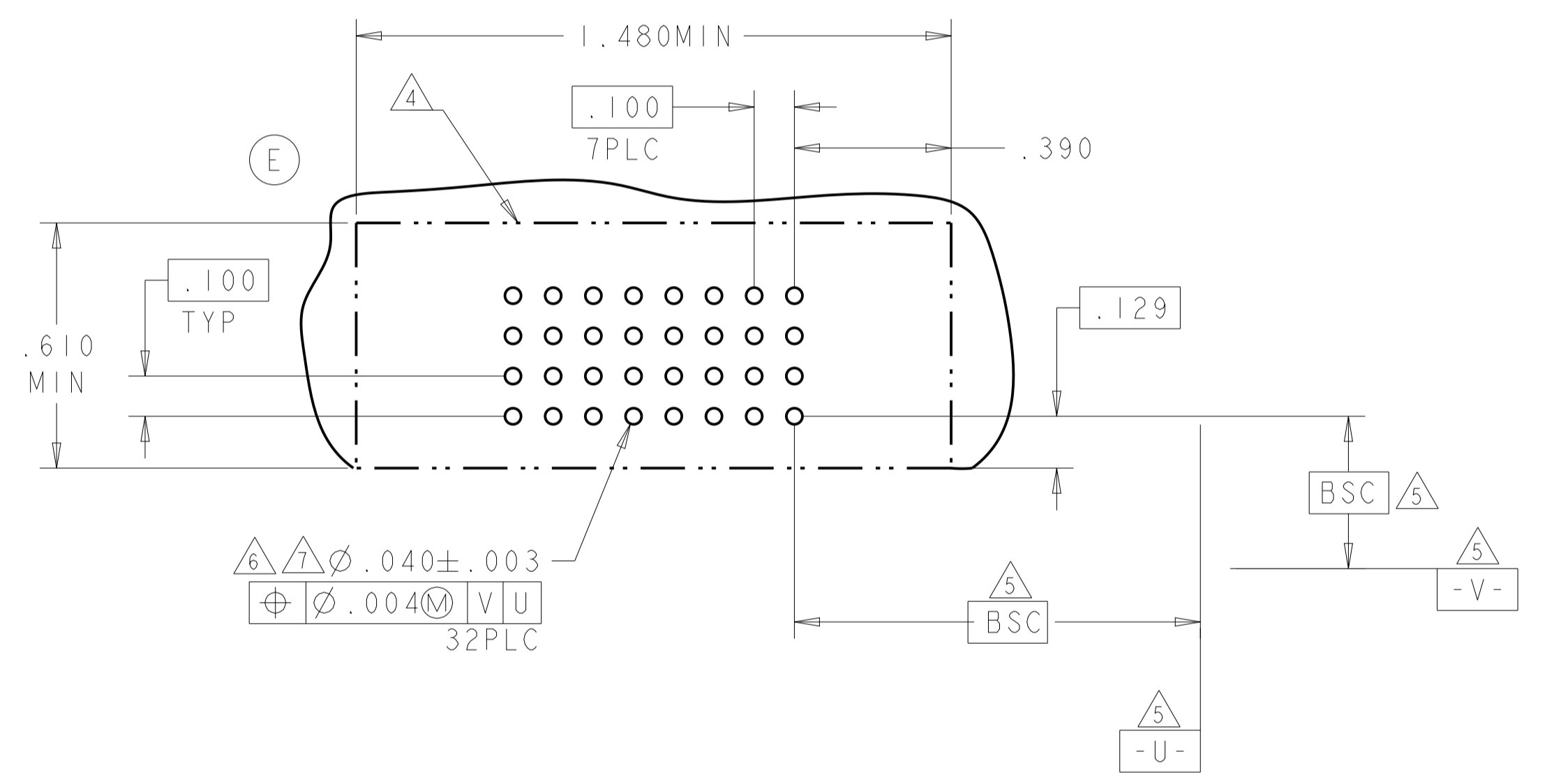
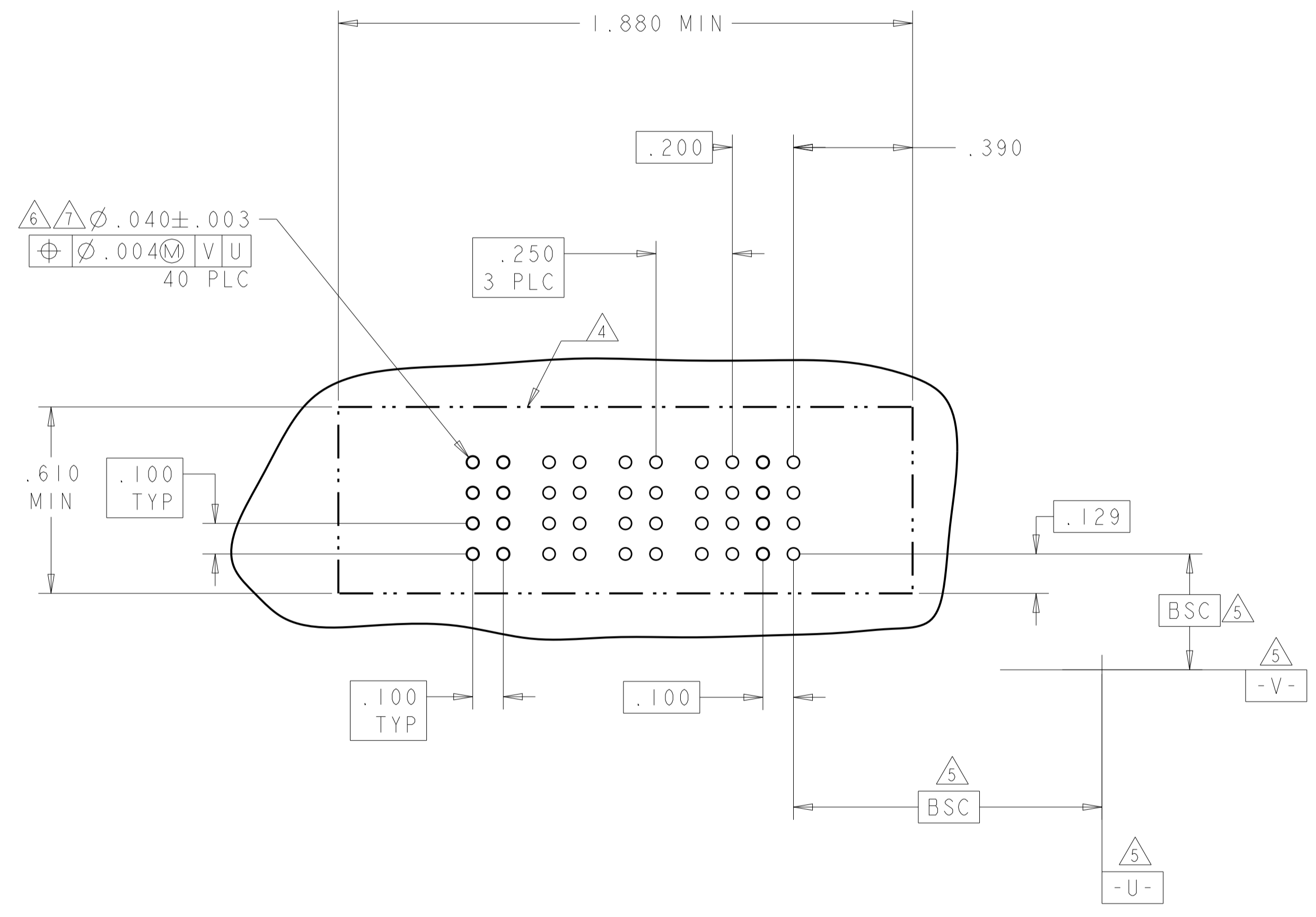

THIS DRAWING IS A CONTROLLED DOCUMENT.

DIMENSIONS:	TOLERANCES UNLESS OTHERWISE SPECIFIED:	OWN	R. GRZYBOWSKI	02MAY05
INCHES	0 PLC ± .01	CHK	M. PERCHERKE	02MAY05
	1 PLC ± .01	APVD	M. PERCHERKE	02MAY05
	2 PLC ± .01	NAME	VERTICAL RECEPTACLE WITH GUIDES MULTI-BEAM XL	
	3 PLC ± .005	PRODUCT SPEC	108-1973	
	4 PLC ± .002	APPLICATION SPEC	114-13038	
	ANGLES ± .020	SIZE	CAGE CODE	DRAWING NO
MATERIAL	FINISH	WEIGHT	A100779	C=6450541
		CUSTOMER DRAWING	SCALE	4:1

RESTRICTED TO SHEET 10 OF 12 REV E.4

LOC	DIST	REVISIONS			
P	LTN	DESCRIPTION	DATE	DMN	APVD
GP	00	SEE SHEET 1			

ASSY PART NUMBER	ROWS	SIGNAL														
		16	15	14	13	12	11	10	9	8	7	6	5	4	3	2
2-6450541-5	D	AP	AP	AP	AP	AP	AP	AP	AP	AP	AP	AP	AP	AP	AP	AP
	C	AP	AP	AP	AP	AP	AP	AP	AP	AP	AP	AP	AP	AP	AP	AP
	B	AP	AP	AP	AP	AP	AP	AP	AP	AP	AP	AP	AP	AP	AP	AP
	A	AP	AP	AP	AP	AP	AP	AP	AP	AP	AP	AP	AP	AP	AP	AP
64S																

ASSY PART NUMBER	ROWS	POWER						SIGNAL					
		P6	P5	P4	P3	P2	P1	6	5	4	3	2	1
2-6450541-6	D	GP	GP	GP	GP	GP	GP	AP	AP	AP	AP	AP	AP
	C	GP	GP	GP	GP	GP	GP	AP	AP	AP	AP	AP	AP
	B	GP	GP	GP	GP	GP	GP	AP	AP	AP	AP	AP	AP
	A	GP	GP	GP	GP	GP	GP	AP	AP	AP	AP	AP	AP
24S + 6P													

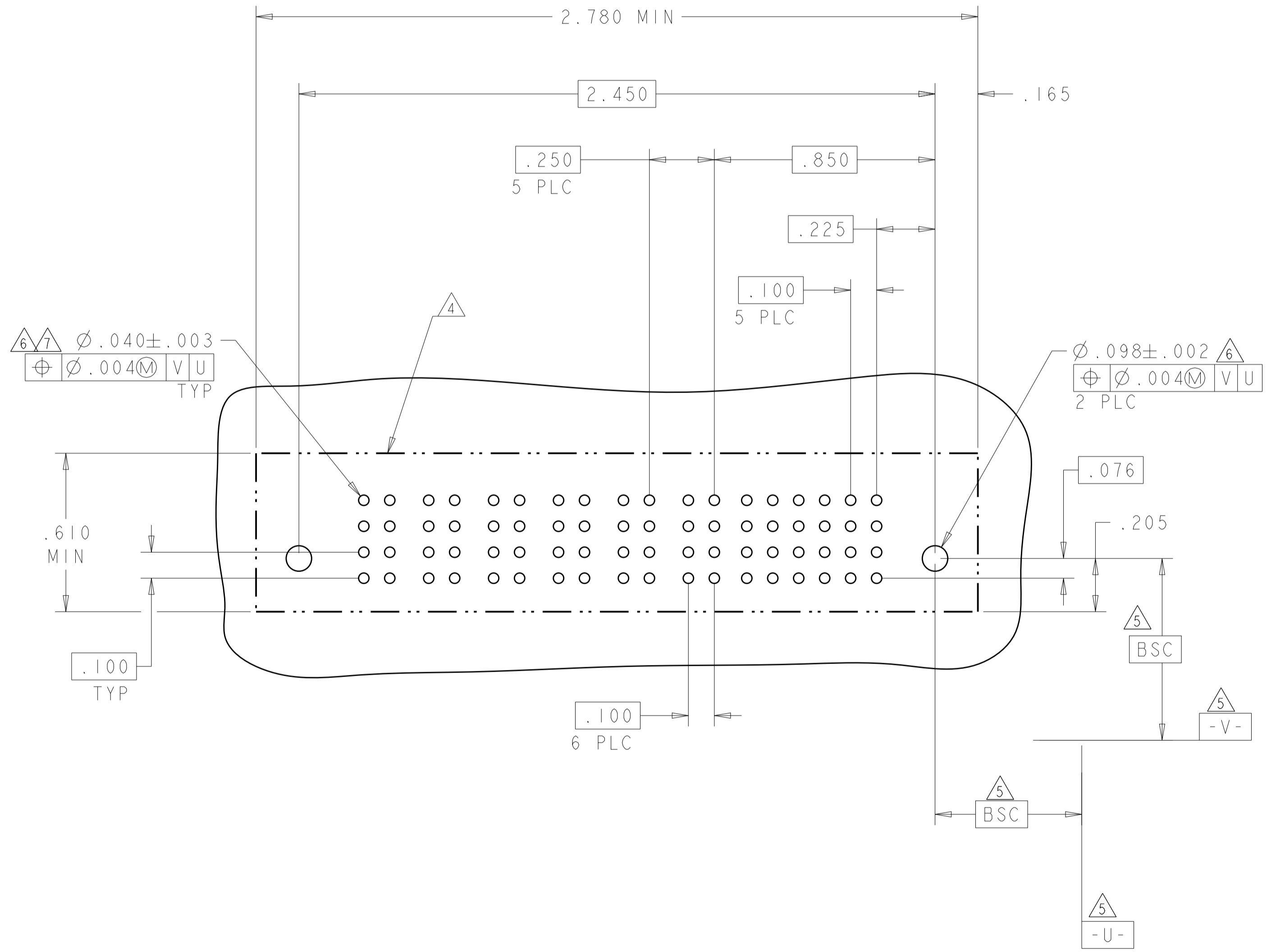
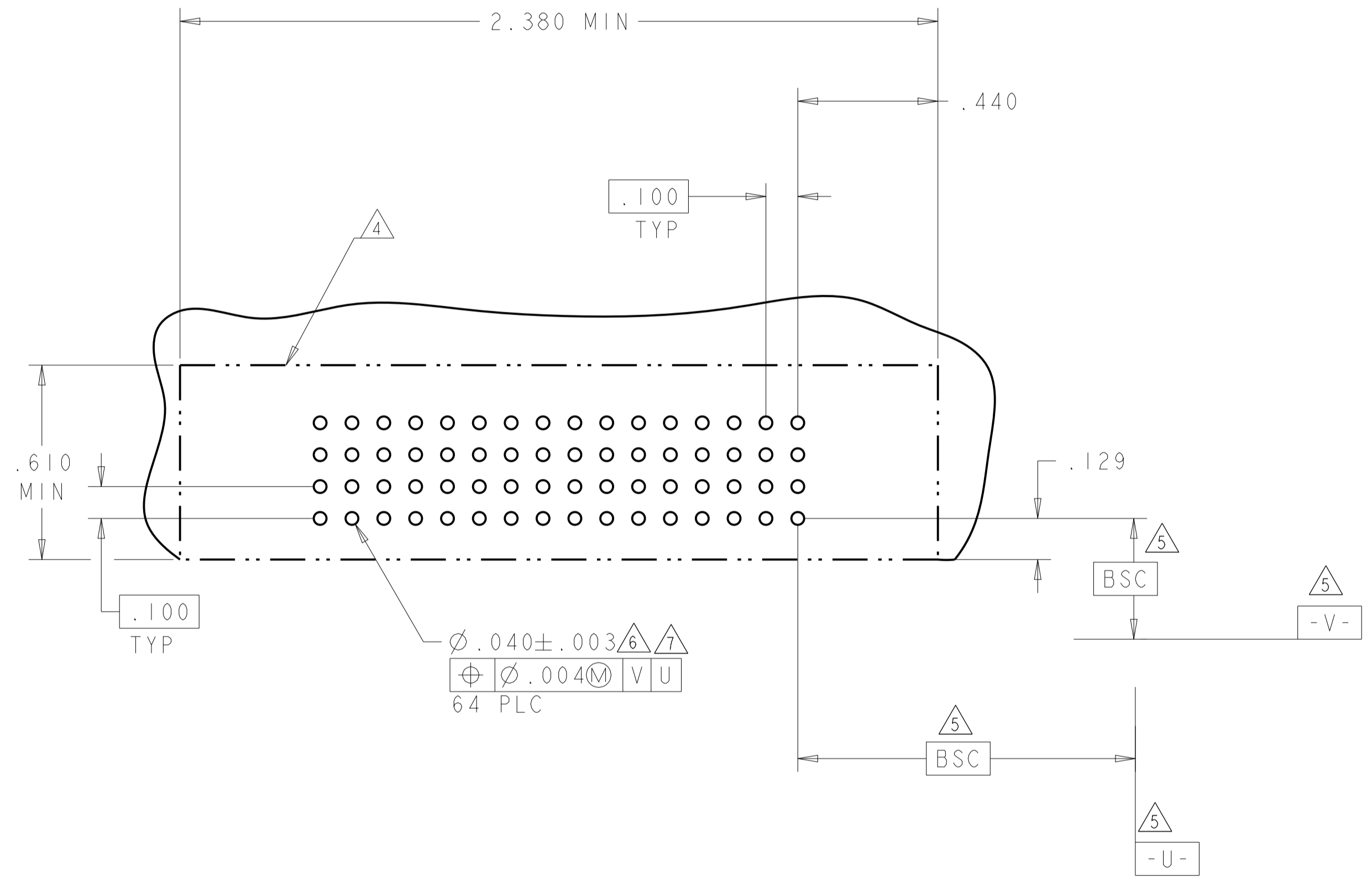

THIS DRAWING IS A CONTROLLED DOCUMENT.		DMN R. GRZYBOWSKI	02MAY05	STE TE Connectivity													
DIMENSIONS: INCHES		CHK M. PERCHERKE	02MAY05														
TOLERANCES UNLESS OTHERWISE SPECIFIED:		APVD M. PERCHERKE	02MAY05	NAME VERTICAL RECEPTACLE WITH GUIDES MULTI-BEAM XL													
<table border="1"> <tr><td>0 PLC</td><td>±</td></tr> <tr><td>1 PLC</td><td>±.01</td></tr> <tr><td>2 PLC</td><td>±.005</td></tr> <tr><td>3 PLC</td><td>±.002</td></tr> <tr><td>4 PLC</td><td>±.002</td></tr> <tr><td>ANGLES</td><td>±.020</td></tr> <tr><td>FINISH</td><td>±.020</td></tr> </table>		0 PLC	±		1 PLC	±.01	2 PLC	±.005	3 PLC	±.002	4 PLC	±.002	ANGLES	±.020	FINISH	±.020	PRODUCT SPEC 108-1973
0 PLC	±																
1 PLC	±.01																
2 PLC	±.005																
3 PLC	±.002																
4 PLC	±.002																
ANGLES	±.020																
FINISH	±.020																
MATERIAL	FINISH	WEIGHT	SCALE	RESTRICTED TO													
			4:1														
CUSTOMER DRAWING		SIZE A100779	DRAWING NO C=6450541	SHEET 12 OF 12													
		REV E4															



Компания «ЭлектроПласт» предлагает заключение долгосрочных отношений при поставках импортных электронных компонентов на взаимовыгодных условиях!

Наши преимущества:

- Оперативные поставки широкого спектра электронных компонентов отечественного и импортного производства напрямую от производителей и с крупнейших мировых складов;
- Поставка более 17-ти миллионов наименований электронных компонентов;
- Поставка сложных, дефицитных, либо снятых с производства позиций;
- Оперативные сроки поставки под заказ (от 5 рабочих дней);
- Экспресс доставка в любую точку России;
- Техническая поддержка проекта, помощь в подборе аналогов, поставка прототипов;
- Система менеджмента качества сертифицирована по Международному стандарту ISO 9001;
- Лицензия ФСБ на осуществление работ с использованием сведений, составляющих государственную тайну;
- Поставка специализированных компонентов (Xilinx, Altera, Analog Devices, Intersil, Interpoint, Microsemi, Aeroflex, Peregrine, Syfer, Eurofarad, Texas Instrument, Miteq, Cobham, E2V, MA-COM, Hittite, Mini-Circuits, General Dynamics и др.);

Помимо этого, одним из направлений компании «ЭлектроПласт» является направление «Источники питания». Мы предлагаем Вам помощь Конструкторского отдела:

- Подбор оптимального решения, техническое обоснование при выборе компонента;
- Подбор аналогов;
- Консультации по применению компонента;
- Поставка образцов и прототипов;
- Техническая поддержка проекта;
- Защита от снятия компонента с производства.



Как с нами связаться

Телефон: 8 (812) 309 58 32 (многоканальный)

Факс: 8 (812) 320-02-42

Электронная почта: org@eplast1.ru

Адрес: 198099, г. Санкт-Петербург, ул. Калинина, дом 2, корпус 4, литера А.